

Owner's Handbook

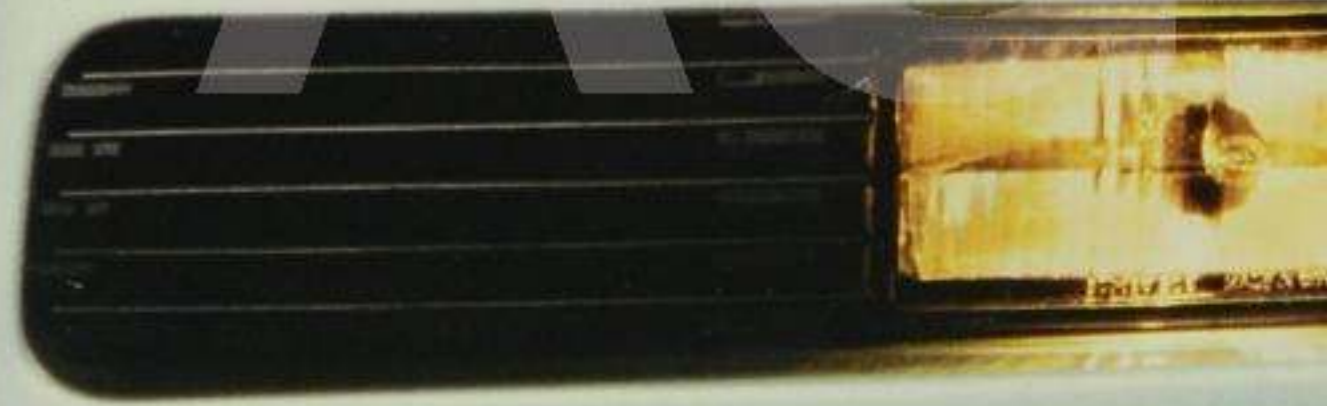

BMW AG





840 Ci

850 Ci

850 Csi

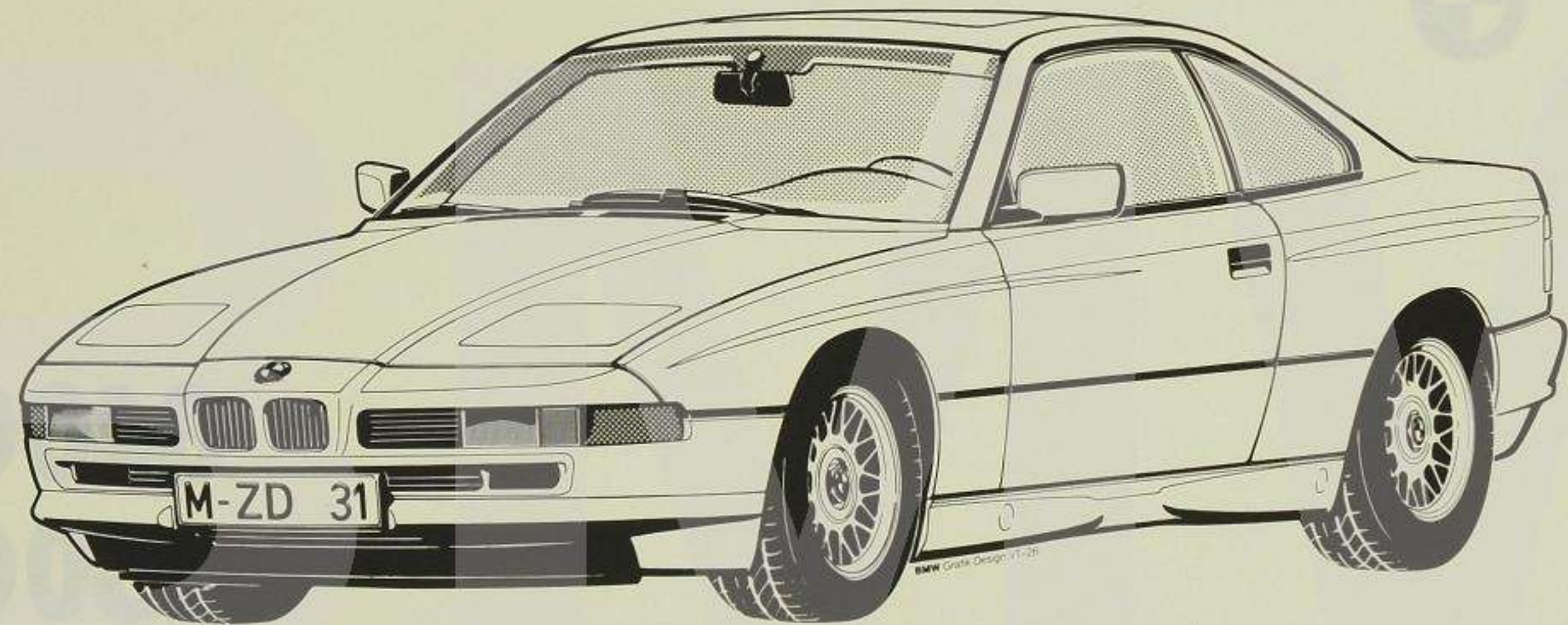

For your own safety, always use belts and accessories which have been approved by BMW.

In the case of Original BMW Parts and Accessories, you can be sure that BMW has tested and approved them as suitable for your car. BMW cannot accept liability for damage if the accessories are not suitable.

BMW is unable to accept any form of liability for parts, accessories or other products which it has not approved.

BMW's engineering department will provide the necessary technical information for the repair of any part of your car. This information is contained in the BMW Repair Manual, which you can purchase from your BMW dealer. The Repair Manual is available in German, French, English and Spanish. It is also available in other languages on request. The Repair Manual is a valuable reference for all BMW owners and is essential for anyone who is involved in the repair of a BMW car.

Original BMW Parts and Accessories are the only products approved by BMW and designed for BMW Service, which will ensure your car is kept in the best possible condition.

Please note that the Owner's Handbook also contains details of the location of the various components of the car. The location of the various components is indicated by a letter and a number.

Items marked with a star symbol (*) are not necessarily part of the car's standard equipment. Specification on all models of a particular car or area may be available only on request. Details of accessories, including the location of your BMW dealer, are given in the

Your decision in favour of a BMW is a source of great pleasure to us as its manufacturers.

The more familiar you are with everything your car can do, the more confident you will be when driving it in all conditions.

We therefore strongly recommend you to study the information we have compiled for you before you start to drive the car. It contains important hints on correct operation of the controls, so that you benefit fully from your BMW's many advanced technical features. There are also full details of maintenance and general care, with the aim of keeping your car fully operational and safe at all times, and maintaining its value.

Wishing you every possible driving pleasure,

BMW AG

In the interests of continuing development we reserve the right to modify design, equipment and accessories.

Important technical data

BMW is a registered trademark of BMW AG. The BMW logo is a registered trademark of BMW AG. The BMW name is a registered trademark of BMW AG. The BMW logo and name are used here with the permission of BMW AG.

BMW is a registered trademark of BMW AG. The BMW logo is a registered trademark of BMW AG. The BMW name is a registered trademark of BMW AG. The BMW logo and name are used here with the permission of BMW AG.

BMW is a registered trademark of BMW AG. The BMW logo is a registered trademark of BMW AG. The BMW name is a registered trademark of BMW AG. The BMW logo and name are used here with the permission of BMW AG.

BMW is a registered trademark of BMW AG. The BMW logo is a registered trademark of BMW AG. The BMW name is a registered trademark of BMW AG. The BMW logo and name are used here with the permission of BMW AG.

BMW is a registered trademark of BMW AG. The BMW logo is a registered trademark of BMW AG. The BMW name is a registered trademark of BMW AG. The BMW logo and name are used here with the permission of BMW AG.

BMW is a registered trademark of BMW AG. The BMW logo is a registered trademark of BMW AG. The BMW name is a registered trademark of BMW AG. The BMW logo and name are used here with the permission of BMW AG.

BMW is a registered trademark of BMW AG. The BMW logo is a registered trademark of BMW AG. The BMW name is a registered trademark of BMW AG. The BMW logo and name are used here with the permission of BMW AG.

BMW is a registered trademark of BMW AG. The BMW logo is a registered trademark of BMW AG. The BMW name is a registered trademark of BMW AG. The BMW logo and name are used here with the permission of BMW AG.

BMW is a registered trademark of BMW AG. The BMW logo is a registered trademark of BMW AG. The BMW name is a registered trademark of BMW AG. The BMW logo and name are used here with the permission of BMW AG.

BMW is a registered trademark of BMW AG. The BMW logo is a registered trademark of BMW AG. The BMW name is a registered trademark of BMW AG. The BMW logo and name are used here with the permission of BMW AG.

BMW is a registered trademark of BMW AG. The BMW logo is a registered trademark of BMW AG. The BMW name is a registered trademark of BMW AG. The BMW logo and name are used here with the permission of BMW AG.

In the interests of continuing development, we reserve the right to modify designs, equipment and accessories.

Dimensions, weights and performance data quoted in this handbook include the appropriate tolerances according to German Industrial Standards (DIN). Variations are also possible on national-market versions of the car.

Fuel consumption figures are as determined at the time of closing for print.

Please note that no claims whatsoever will be entertained on the basis of data, descriptions or illustrations contained in this handbook. Errors and omissions excepted.

Please note that this Owner's Handbook also contains descriptions of how to operate all the equipment that may be fitted to the car, including items available as optional extras.

Items marked with a large asterisk * are not necessarily part of the car's standard equipment specification on all models or in all countries, or else may be available only as optional extras or accessories. Furthermore, the specification of your BMW will vary according to the items of equipment originally ordered for it. Descriptions of items of equipment not found in this handbook are given in the installation or operating instructions accompanying such items.

If you are in any doubt, please contact BMW Service for advice and assistance.

In the interests of operating reliability and safety, and also with a view to maintaining the value of your BMW, you are urged not to alter its specification in any way which could invalidate its general operating permit or depart from the manufacturer's recommendations.

Note: important safety information

For your own safety, always use parts and accessories which have been approved by BMW.

In the case of Original BMW Parts and Accessories, you can be sure that BMW has tested and approved them as suitable for your car. BMW accepts liability for these items if installed according to its instructions.

BMW is unable to accept any form of liability for parts, accessories or other products which it has not approved.

BMW clearly cannot assess every product of outside origin in order to ensure that it represents no risk of injury to the user if installed or operated in conjunction with a BMW automobile. Nor can approval by an official technical inspection authority or the issue of a general operating permit by a government body provide absolute assurance that a product is entirely suitable, since the tests performed by such bodies tend to be of a more general nature only.

Original BMW Parts and Accessories and other products approved by BMW are available from BMW Service, which will gladly provide competent advice on all related matters.

Important facts in brief



The controls



Operating hints



Care and maintenance



Technical data



Index A-Z

Driving area	8
Instrument cluster	9
Telltale and warning lights	10
Distance recorder	12
Revolution counter	12
Fuel gauge, coolant temperature gauge, horn	13
Ignition/starter switch and steering lock	14
Starting and stopping the engine	15
Running in	16
Energy-conscious driving	17
Refuelling	18
Tyre pressures	19

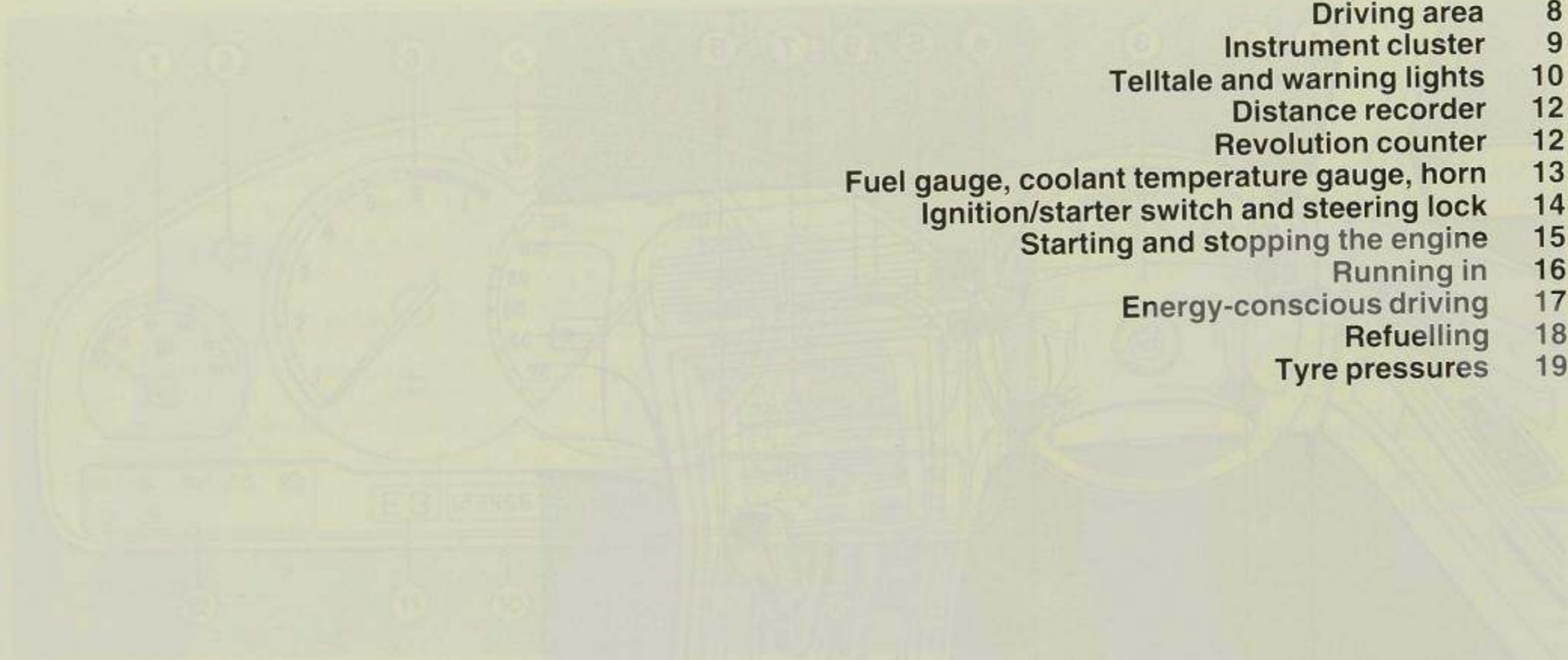

Instrument panel	Part	Function
1	Speedometer	Shows the vehicle's speed in km/h or mph.
2	Tachometer	Shows the engine's revolutions per minute (RPM).
3	Fuel gauge	Shows the amount of fuel in the tank.
4	Coolant temperature gauge	Shows the engine's coolant temperature.
5	Horn	Used to alert other drivers.
6	Ignition/starter switch	Used to start the engine.
7	Steering lock	Prevents the steering wheel from being turned when the engine is off.
8	Distance recorder	Records the distance traveled.
9	Revolution counter	Shows the total number of engine revolutions.
10	Telltale and warning lights	Indicates various system malfunctions.
11	Energy-conscious driving indicator	Shows the engine's operating mode.
12	Refuelling indicator	Shows the fuel filler door location.
13	Tyre pressure indicator	Shows the tyre pressure.
14	Brake system indicator	Shows the brake system status.
15	ABS indicator	Shows the ABS system status.
16	ESP indicator	Shows the ESP system status.
17	Engine oil level indicator	Shows the engine oil level.
18	Engine oil pressure indicator	Shows the engine oil pressure.
19	Engine oil temperature indicator	Shows the engine oil temperature.

Important facts in brief

Read the manual for the engine, equipment and accessories. The manual contains the information you need to know about the engine, equipment and accessories. It also contains the information you need to know about the engine, equipment and accessories.

Operating instructions

Read the manual for the engine, equipment and accessories. The manual contains the information you need to know about the engine, equipment and accessories. It also contains the information you need to know about the engine, equipment and accessories.

Care and maintenance

Read the manual for the engine, equipment and accessories. The manual contains the information you need to know about the engine, equipment and accessories. It also contains the information you need to know about the engine, equipment and accessories.

Technical data

Read the manual for the engine, equipment and accessories. The manual contains the information you need to know about the engine, equipment and accessories. It also contains the information you need to know about the engine, equipment and accessories.

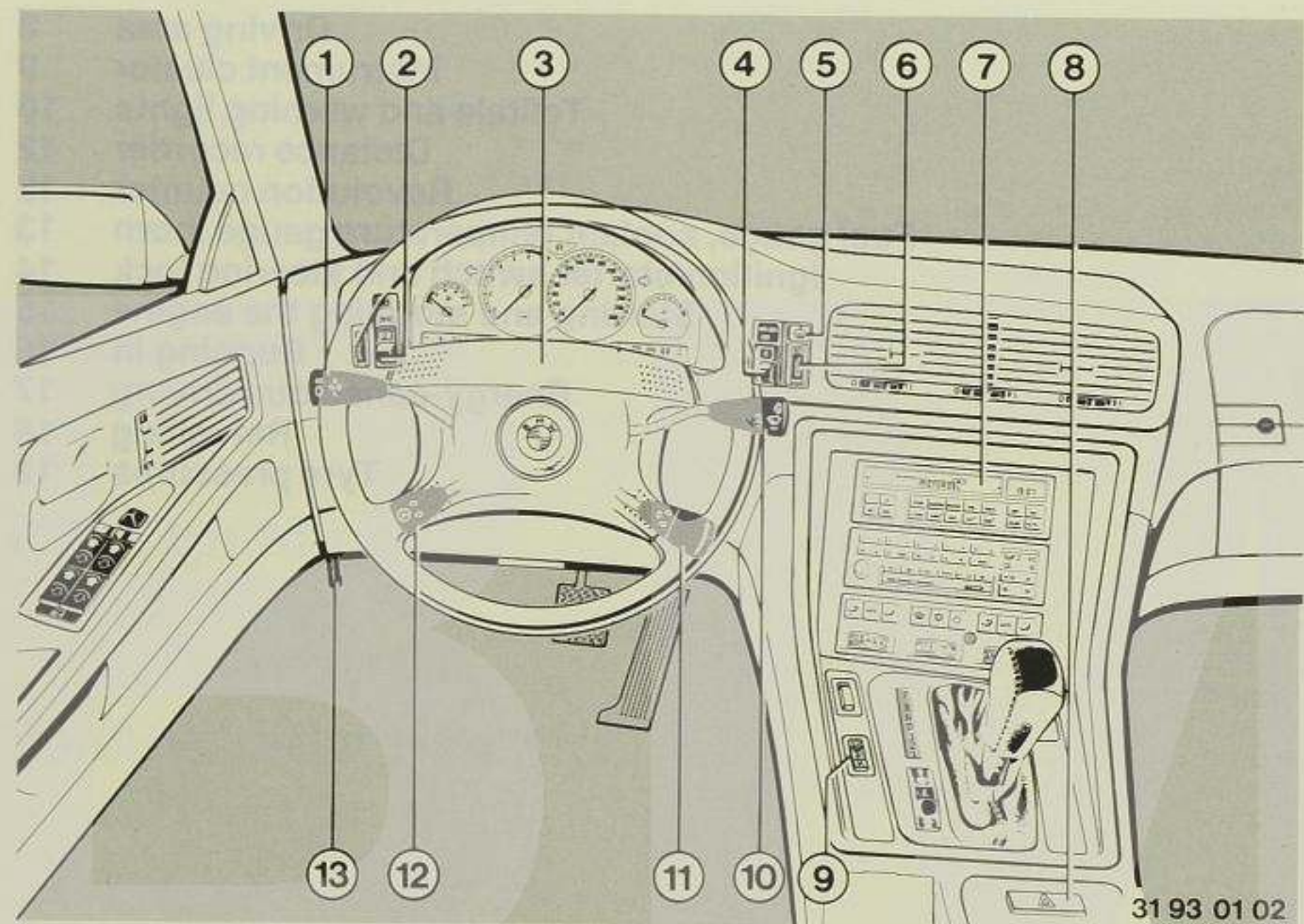

Driving area

1 Lever for flashing turn indicators, parking lights, dipped headlights and headlight flasher	Page 37	6 Knurled wheel for headlight beam throw adjustment *	Page 38
2 Main light switch	Page 36	7 Multi-Information Display (MID)	Page 42
3 Horn	Page 13	8 Switch for hazard warning flashers	Page 37
4 Fog light switch	Page 37	9 Switch for programmable electronic power control (EML), 850 CSi only	Page 56
5 Switch for heated rear window	Page 69		

10 Wipe/wash control lever	Page 39
11 Cruise control lever	Page 62
12 Lever for electric steering-wheel adjustment *	Page 30
13 Engine compartment release lever	Page 80

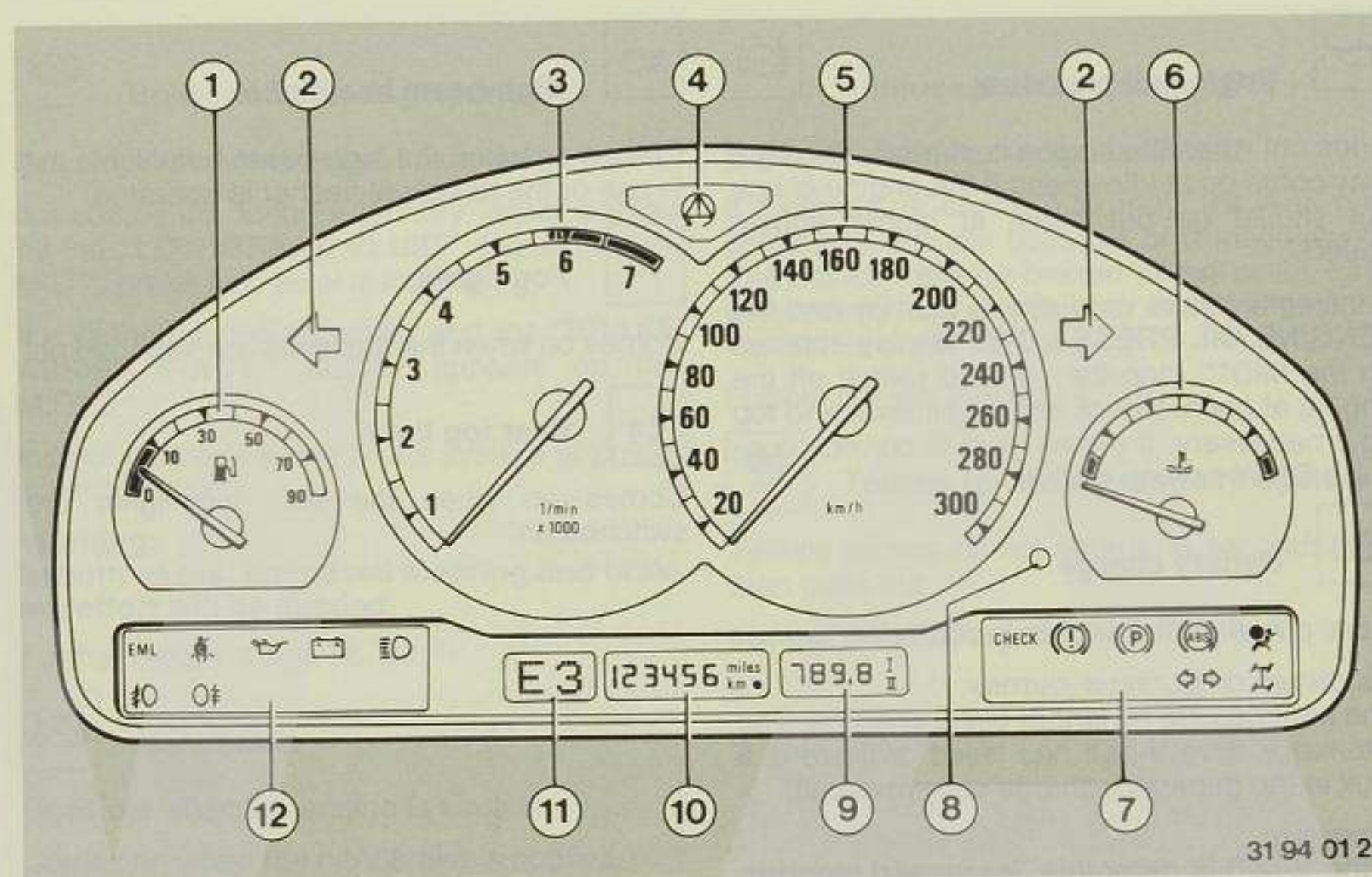

Instrument panel

1 Fuel gauge with warning light for reserve supply	Page 13	7 Check Control indicator light and telltale and warning lights for brake system and steering hydraulics, handbrake, ABS, AIRBAG, AHK* and trailer flashing turn indicators	Page 53, 11
2 Turn indicator repeaters	Page 10	8 Trip distance reset knob and changeover knob for second trip distance display	Page 11
3 Revolution counter	Page 12	9 Trip distance recorder	Page 11
4 Telltale light for ASC+T*/DSC*	Page 10	10 Distance recorder	Page 12
5 Speedometer	Page -		
6 Coolant temperature gauge	Page 13		

* ASC+T = Automatic Stability Control plus Traction
DSC = Dynamic Stability Control

* AHK = Active Rear Axle Kinematics

11 Driving program and selector lever position indicator for automatic transmission (on BMW 850 CSi, with S display for electronic power control)	Page 57, 56
12 Telltale and warning lights for electronic power control (EML), engine oil pressure, battery charge, high-beam headlights and front and rear fog lights	Page 10

Telltale and warning lights

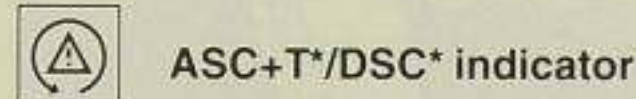

ASC+T*/DSC* indicator

Goes out when engine is started if system is in working order.

Further details: Page 63, 65.

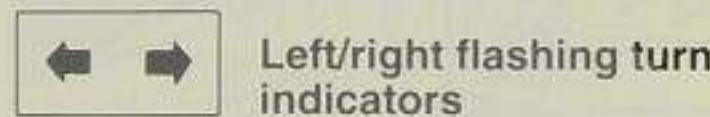

Left/right flashing turn indicators

Comes on rhythmically when the flashing turn indicators are in use.

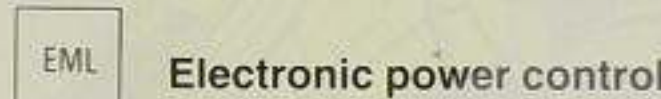

Electronic power control

Comes on briefly when the ignition is switched on and goes out again if the system is in working order.

If the light remains on or comes on again during a journey, the system is defective. However, the car can still be driven, and should be taken to the nearest BMW service station.

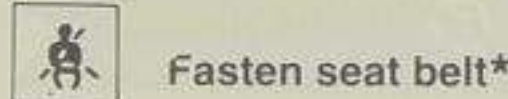

Fasten seat belt*

(Possibly together with acoustic signal* and/or display on the MID*.)

Comes on briefly when the ignition is switched on, then goes out (depending on version, signal may go out only after the seat belt has been fastened).

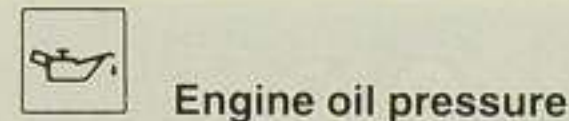

Engine oil pressure

Goes out when the engine is started. This light may come on at idle speed if the engine is hot, but should go out again at higher engine speeds.

If the light comes on during a journey and the "ENGINE OIL PRESS LOW" display appears on the MID**: stop the car and switch off the engine at once. Check engine oil level and top up if necessary. If the oil level is correct, consult a BMW service station.



Battery charge

Goes out when the engine is started.

If it comes on during a journey: The batteries are no longer being charged. The alternator drive V-belt has failed or there is a fault in the generator charge current circuit.

Warning:
If the V-belt is defective, increased steering and braking effort will be needed.

Cars with a second alternator*: A second bulb in the telltale light monitors the charge current for the second alternator. If the main alternator should fail, the car can still be driven for approx. 2 hours with the telltale light on, provided that no additional electrical consumers are switched on.

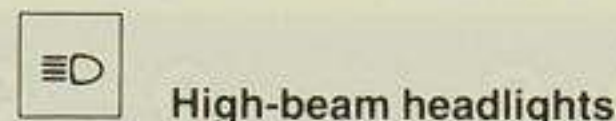

High-beam headlights

Comes on when the high-beam headlights are in use or the headlight flasher is operated.

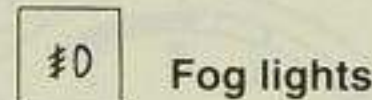

Fog lights

Comes on when the fog lights are switched on.

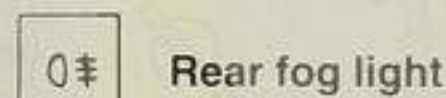

Rear fog light

Comes on when the rear fog lights are switched on.

* ASC+T = Automatic Stability Control plus Traction
* DSC = Dynamic Stability Control
** MID = Multi-Information Display

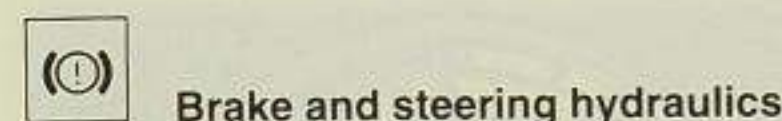

Brake and steering hydraulics

Goes out when the engine is started.

If it comes on during a journey, accompanied by the "LOW BREAK FLUID" display on the MID**: brake fluid level is too low.

If it flashes during a journey and the "BRAKE ASSIST INACT." display appears on the MID**:

loss of pressure in the brake system or power steering circuit.

Warning:
In both cases, increased steering and braking effort will be needed.

Further details: Page 86, 90.

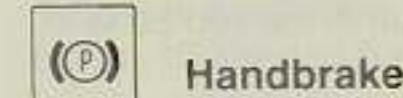

Handbrake

Goes out when the engine is started.

Comes on when the handbrake is applied.

* MID = Multi-Information Display

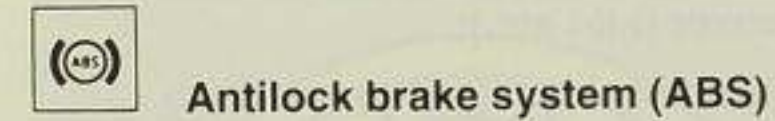

Antilock brake system (ABS)

Goes out when the engine is started.

If it comes on during a journey, the ABS has ceased to operate because of a malfunction. The car can still be braked in the usual way, without any loss of efficiency; only the antilock function is out of action.

Further details: Page 114.

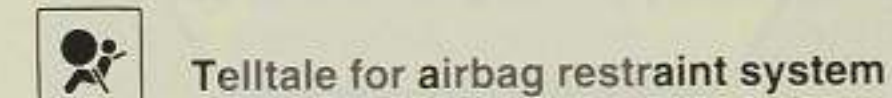

Telltale for airbag restraint system

Telltale comes on for approx. 6 seconds and then goes out.

Further details: Page 35.

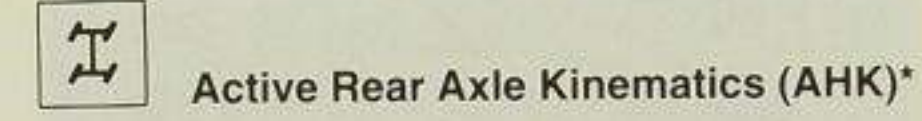

Active Rear Axle Kinematics (AHK)*

Goes out when the engine is started if the system is in working order.

If it comes on during a journey and the R/AXLE FAILSAFE PROG display appears on the MID: The AHK has cut out as a result of a fault. The car can still be driven. If the steering wheel is slightly off-centre when driving in a straight line, the car will veer slightly from the chosen line of travel.

Further details: Page 115.

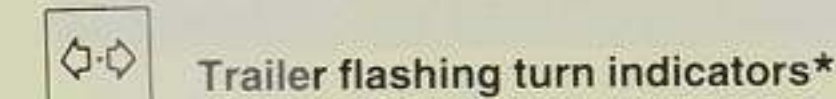

Trailer flashing turn indicators*

Flashes together with the main turn indicator repeater if a turn is signalled while a trailer is being towed.

Further details: Page 110.

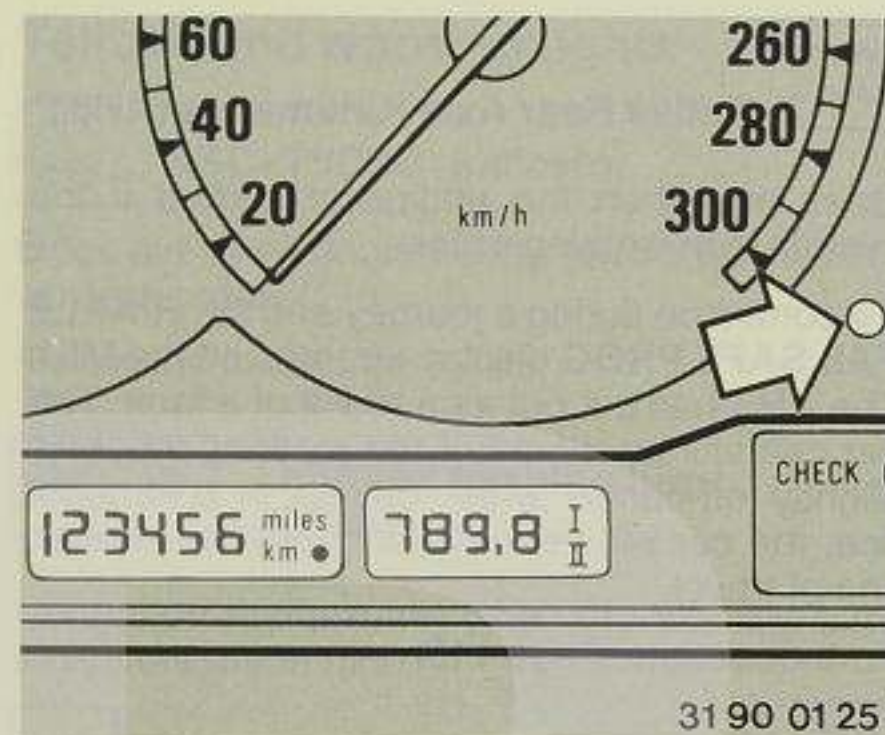

31 90 01 25

Distance recorder

The distance recorder shows the total distance in miles or kilometres which the car has covered.

Trip distance displays I and II

You can choose between two trip distance displays (e.g. one for the whole journey and one for a specific period of driving only) and reset either of them to zero independently. Both displays show distances up to 999.9 miles/km.

Changeover (I-II-I etc.):

– Turn the reset knob (arrow) clockwise.

Resetting to zero:

– Select the desired display first, then **press** the reset knob.

Up to 2 minutes after the ignition has been switched off, the display remains visible and adjustments are possible. When the distance display is not visible, it can be recalled for a short period by pressing the reset knob.

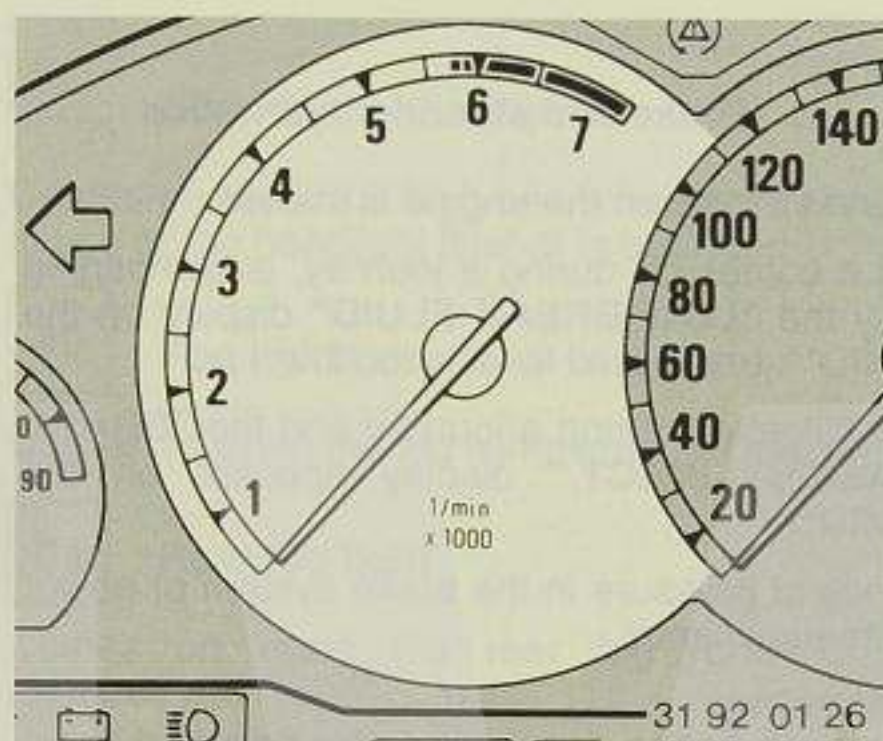

31 92 01 26

Revolution counter

Never allow the engine to run in the red zone of the revolution counter.

In this zone the fuel supply is interrupted to protect the engine. This becomes evident as intermittent ignition cutout.

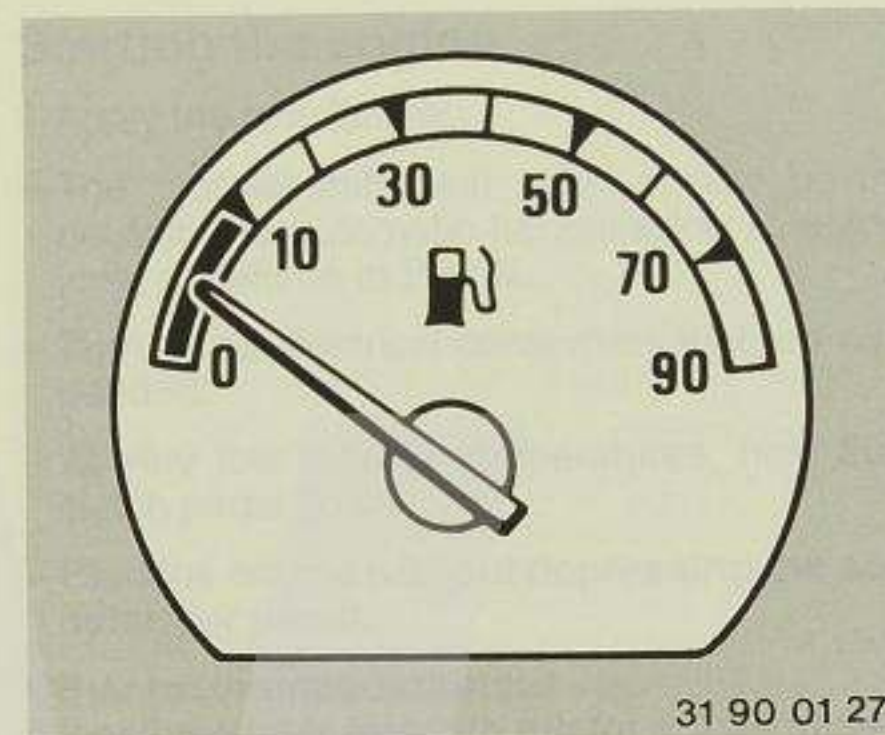

31 90 01 27

Fuel gauge

When the warning light comes on, there are about 10 litres of fuel left in the tank.

The warning light comes on briefly as an operating check when the ignition is switched on.

You can display the probable action radius on the fuel remaining in the tank on the on-board computer.

See Page 48.

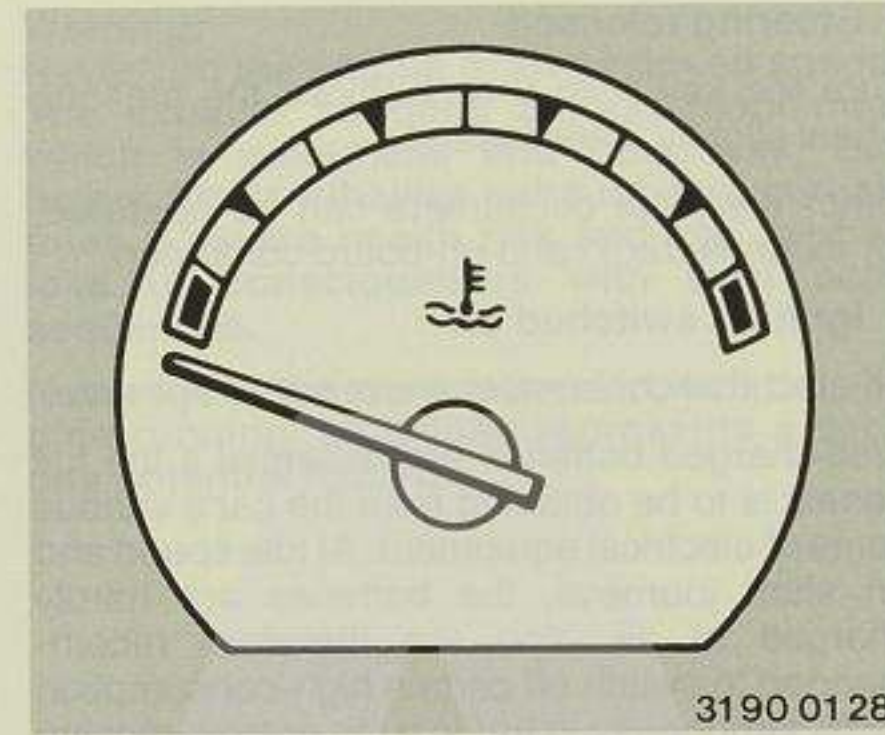

3190 0128

Coolant temperature gauge

Blue: the engine is cold. Drive at moderate engine and road speeds.

Red, with "COOLANT TEMPERATURE" display on MID: the engine is too hot. Switch it off at once and allow to cool down.

Pointer between the two coloured zones:

normal operating temperature. At high outside temperatures or when loads on the car are severe, the pointer may move up as far as the beginning of the red zone.

Checking coolant level: Page 88.



31 92 02 24

Horn

Press the centre pad (the airbag cover) on the steering wheel at any convenient point.

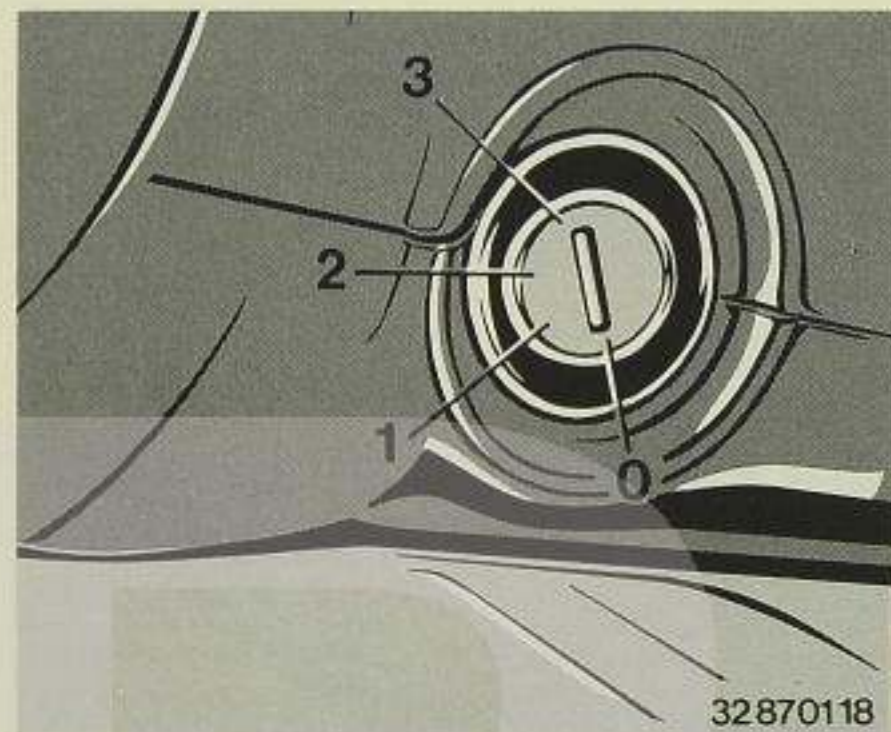

Ignition/starter switch and steering lock

0 Steering locked

The key can only be inserted and removed in this position.

After removing the key, turn the steering wheel slightly to make sure that the steering lock has engaged.

Most electrical consumers are switched off, but some can still be operated: side and parking lights, interior lighting, hazard warning flashers, electric seat position adjustment and cigarette lighter.

1 Steering released

Turn the key from 0 to 1 (move the steering wheel slightly if necessary).

Other electrical consumers can be operated, for example radio and on-board computer.

2 Ignition switched on

All electrical consumers are ready to operate.

Well-charged batteries are essential if the full benefit is to be obtained from the car's various items of electrical equipment. At idle speed and on short journeys, the batteries are hardly charged at all. You are therefore recommended to switch off certain high-consumption items temporarily in traffic jams or slow-moving traffic if their use is not absolutely essential (for example seat heating or heated rear window).

A very small electrical current flows all the time to certain items of equipment so that their memory function is maintained. Bear this in mind if the car is parked out of use for a lengthy period (more than approx. 4 weeks). In this situation, it is best to disconnect the batteries from the car's electrical circuit at the negative battery terminals (see Page 91).

3 Starter motor operated

Starting the engine

- Apply the handbrake.
- The manual-shift gear lever should be in neutral; the automatic transmission selector lever should be in P or N.
- Turn off all electrical consumers that are not needed.
- At very low outside temperatures, hold the clutch pedal down.
- Start the engine **without depressing the accelerator pedal.**

Other recommendations:

Allow the starter motor to run for a reasonable time, but not for more than about 20 seconds. As soon as the engine fires, release the ignition key. Do not allow the engine to warm up at a standstill, but drive off as soon as possible, using moderate engine speeds.

If the engine does not start first time, for instance if it is very cold or very hot:

- Observe a slight pause before operating the starter motor again; this will prevent the spark plugs from becoming wet with excess fuel. In conditions of severe frost, the pause should be 20 to 30 seconds long.
- Turn the key back to position 1 or 0 before making a renewed attempt to start the engine. This delay will prevent the starter motor from trying to engage while the engine is still rotating.
- Depress the accelerator pedal halfway while starting the engine.

Warning:

Never run the engine in an enclosed space. The exhaust contains carbon monoxide, which is colourless and odourless, but highly toxic. Inhaling exhaust gas constitutes a severe health risk and can lead to loss of consciousness with fatal consequences.

Never leave the car unattended with the engine running, as it then represents a serious potential hazard.

Switching off the engine

Turn the ignition key back to 1 or 0.

Warning:

Never take the ignition key out when the car is still in motion, or the steering lock will engage.

Whenever the driver leaves the car, he or she should remove the ignition key and lock the steering.

Running in

While the car is being run in, the gear shift, steering etc. may be slightly stiff initially. This effect will soon disappear as the running-in process continues.

Please comply with the following instructions, which are intended to ensure that your car achieves its optimum operating life and economy.

Engine and final drive

Up to a speedometer reading of 1000 km (app. 620 miles):

Drive the car at varying engine and road speeds, but do not exceed a road speed of 140 km/h (87 mile/h).

Avoid the full throttle position of the accelerator and do not use the automatic transmission kick-down.

After 1000 km (app. 620 miles) have been covered, engine and road speeds can be gradually increased.

BMW 850CSi

Up to a speedometer reading of 2000 km (app. 1250 miles):

Do not exceed a max. engine speed of 5500/min.

Max. road speed 160 km/h (100 mile/h). Do not use the full throttle position of the accelerator.

Up to a speedometer reading of 5000 km (app. 3100 miles):

Max. continuous road speed 200 km/h (124 mile/h).

Use top speed for short periods only.

If a major mechanical assembly is exchanged or renewed later in the car's life, please comply with the same running-in instructions.

Tyres

New tyres do not achieve their full road grip immediately, for production reasons. You should therefore drive in a restrained manner for the first 300 km (app. 200 miles). Remember this precaution when tyres are renewed later in the car's life.

Brakes

Maximum brake pad friction and uniform pad surfaces are best obtained if the brakes are applied fairly firmly up to a distance of 500 km (app. 300 miles), but without violent brake applications, particularly from high speeds, or severe loads on the brakes for long periods (e.g. when descending steep mountain roads).

This distance is needed, together with the above running-in precautions, for the brake pads and discs to acquire a satisfactory initial wear and surface pattern.

The handbrake operates separately from the foot brake system, with its own drums, and therefore also has to be run in.

If the braking effect declines noticeably with time, the driver can repeat the bedding-down process provided due care is exercised: If road surface, weather and traffic conditions permit (care must be taken not to obstruct other road users), the desired effect can be achieved by applying the handbrake lightly at about 40 km/h (25 mile/h) until definite resistance is felt. Then pull up the lever to the next notch and drive the car about another 400 metres before releasing the handbrake completely.

Energy-conscious driving

Your car's technical design is ideal for economical driving at reasonable cost. Furthermore, BMW has devoted great attention to minimizing the environmental burden. To make the best possible use of these built-in design features, you are recommended to comply with the following instructions. In this way, you will reduce fuel consumption and pollutant emissions to a minimum and exert a favourable influence on engine, brake and tyre wear.

- Do not warm up the engine with the car at a standstill. Drive away as soon as possible after starting, avoiding high engine speeds at first.

It takes a long time for the engine to warm up at idle speed, but exhaust emissions are higher than usual until the engine reaches its normal operating temperature.

- Always avoid long periods with the engine idling.

Even if the delay is not expected to exceed about 1 minute, it pays to switch off the engine.

- Use 1st gear only to start away from a standstill. Do not remain in this gear right up to peak engine speeds. Shift up in good time to a more economical gear.

The lowest possible fuel consumption and exhaust emissions are achieved at moderate engine speeds in the highest practicable gear.

- Avoid unnecessary ballast.

Carrying items in or on the car when they are not strictly necessary increases consumption, particularly in town traffic.

- Take off roof-mounted luggage racks or ski holders when no longer needed.

These items seriously increase aerodynamic drag and adversely affect fuel consumption, particularly at high speeds.

- Check tyre pressures every 14 days.

If tyre pressures are too low, the car's rolling resistance goes up. Fuel consumption suffers, tyre wear is more rapid and the car's handling deteriorates.



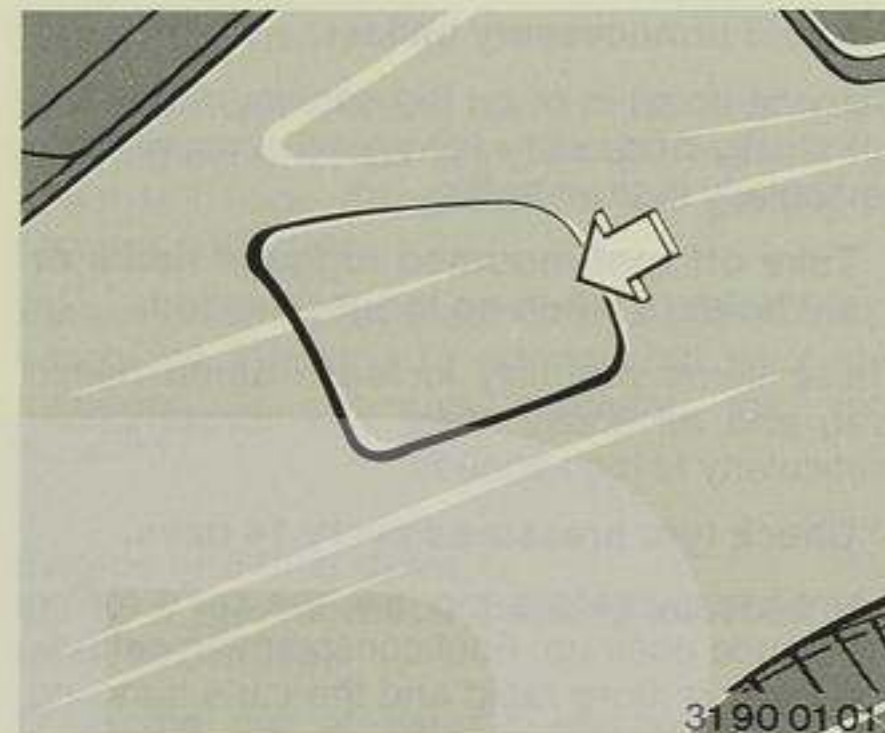

Refuelling

To open the fuel filler flap, press the front end in so that the flap can be lifted.

To open the filler cap inside the flap: turn it anti-clockwise, take it off and place it temporarily in the holder on the filler flap.

To close the cap: attach it to the pipe and turn clockwise as far as possible (bayonet catch).

To release the filler flap if the central locking system fails, see Page 98.

Warning:
Comply with the relevant safety regulations when handling fuel.

Fuel grade required

Cars with catalytic converter

BMW 850Ci

Regular-grade unleaded fuel to DIN 51607 standard or equivalent, minimum octane number 91 (Research Method).

BMW 840Ci²⁾, 850CSi²⁾

Premium-grade unleaded fuel to DIN 51607 standard or equivalent, minimum octane number 95 (Research Method). This fuel is known in certain areas as "Euro-Super".

Cars without catalytic converter¹⁾

BMW 850Ci

All fuels, leaded or unleaded, with minimum octane number 95 (Research Method).

BMW 840Ci²⁾, 850CSi²⁾

Premium-grade unleaded fuel to DIN 51607 standard or equivalent, minimum octane number 95 (Research Method). This fuel is known in certain areas as "Euro-Super".

Or **premium-grade fuel** to DIN 51600 standard or equivalent, octane number 98 or **premium-grade fuel** with minimum octane number 95 (Research Method).

¹⁾ There is provision for retrofitting a catalytic converter
²⁾ It is also possible to use fuel with a minimum octane number of 91 with this knock-controlled engines although this will impair output and fuel consumption

Further routine checks

- Tyre pressures (including spare wheel), twice a month 19
- Engine oil level 81
- Battery acid (top up only with distilled water) 89
- Coolant 86
- Brake fluid 84
- Fluid level in washer systems 87
- Lights (change bulbs if necessary) 100

Tyre pressures – check them regularly for your personal safety!

Incorrect tyre pressures can render the car unstable and lead to tyre damage or even cause an accident.

Tyre pressures in bar (gauge pressure) with tyres cold (cold = ambient temperature).

Note:
Tyre pressures rise as the tyres become hot (e.g. after a period of fast main-road driving) by app. 0.3 bar (3 – 4 psi). Per 10°C of temperature change, the tyre pressure varies by app. 0.1 bar.

When changing a wheel or in the event of a flat tyre

The wheels of your BMW are protected by thiefproof wheel studs.

Always keep an adapter in the vehicle toolkit. This will speed up the wheel-changing procedure at the workshop or by a breakdown recovery service. See also Page 100.

BMW model	Radial-ply tires (tubeless)	max			
		Front	Rear	Front	Rear
840Ci/ 850Ci	235/50 ZR 16 235/45 ZR 17 225/55 R 16 95 Q, T, H M+S 235/50 R 16 95 Q, T, H M+S 235/45 R 17 93 Q, T, H M+S	2,5 (35,5)	2,5 (35,5)	2,6 (37,0)	3,0 (42,7)
	265/40 ZR 17*	– –	2,5 (35,5)	– –	2,8 (39,8)
850CSi	235/45 ZR 17	2,9 (41,2)	– –	3,2 (45,5)	– –
	265/40 ZR 17*	– –	2,9 (41,2)	– –	3,5 (49,8)
	235/45 R 17 93 Q, T, H M+S	2,5 (35,5)	2,7 (38,4)	2,7 (38,4)	3,0 (42,7)

* Only permissible as a mixed set of tyres with 235/45 ZR 17 at front

Figures in brackets = values in pounds per square inch.
When towing a trailer, always use the values for increased load.

These tyre pressures apply to makes of tyre approved by BMW and known to the BMW Service Organization.

If other makes of tyre are fitted to the car, higher tyre pressures may be needed.

Tyre pressures are also shown on the driver's door post.

- Keys 22
- Doors 23
- Infra-red remote control 25
- Thiefproofing system 27
- Seats 28
- Steering column adjustment 30
- Electric steering wheel adjustment 30
- Mirrors 31
- Position memory for seats, mirrors and steering wheel 33
- Seat belts 33
- Airbag restraint system 35
- Main light switch 36
- Fog light switch 37
- Lever for flashing turn indicators and dipped headlights 37
- Hazard warning flashers 37
- Interior lighting/footwell lights 38
- Headlight beam throw adjustment 38
- Wipe/wash system 39
- Electric windows 40
- Sunroof 41
- Multi-Information Display (MID) 42
- Service Interval indicator 43

- Digital clock 44
- On-board computer 46
- Check Control 53
- Handbrake 55
- Programmable Electronic Power Control (EML) 56
- Manual gearbox 56
- Automatic transmission 57
- Adaptive Transmission Control (AGS) 60
- Automatic cruise control 62
- Electronic Damping Control (EDC) 63
- Automatic Stability Control plus Traction (ASC+T) 63
- Dynamic Stability Control (DSC) 65
- Automatic air conditioning 66
- Heated rear window 69
- Independent heating and ventilation 70
- Roller sunblind, glove boxes 71
- Ashtray 72
- Folding rear-seat back 73
- Ski bag 73



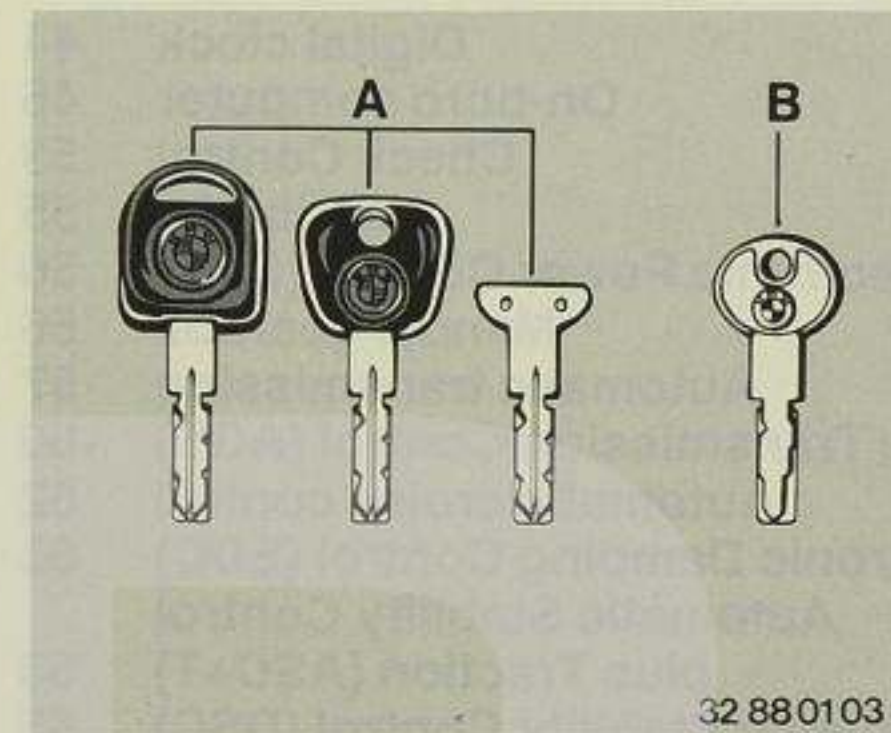

Obtaining a new key:

The key number is on a self-adhesive label which is supplied to you with the car's keys. Please keep the label in a safe place.

Keys

A. Master keys

- Master key* with battery light (switched on by pressing the BMW badge)
- Second key*
- Spare key to keep in a safe place, e.g. in a purse or wallet

B. Key for doors and ignition

This key does not operate the glove box lock.

Note:

If you lock the glove box, you also lock the luggage compartment.

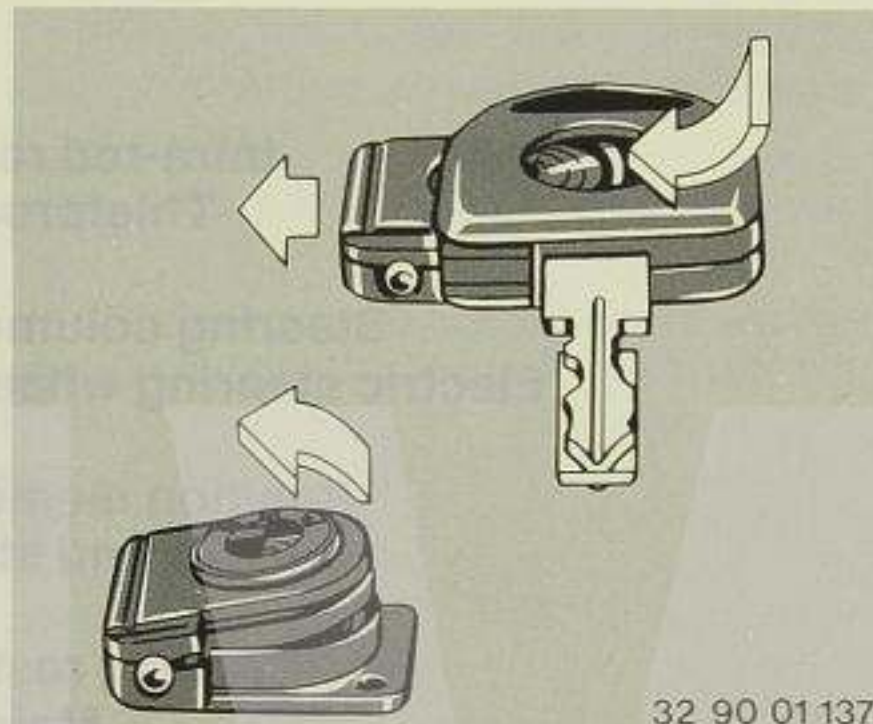

Master key with battery light*

Renew the battery if the light becomes dim, or else battery acid may begin to leak out.

Renewing the battery: see illustration.



Dispose of old batteries at an authorized collecting point or hand them back to a BMW service station.

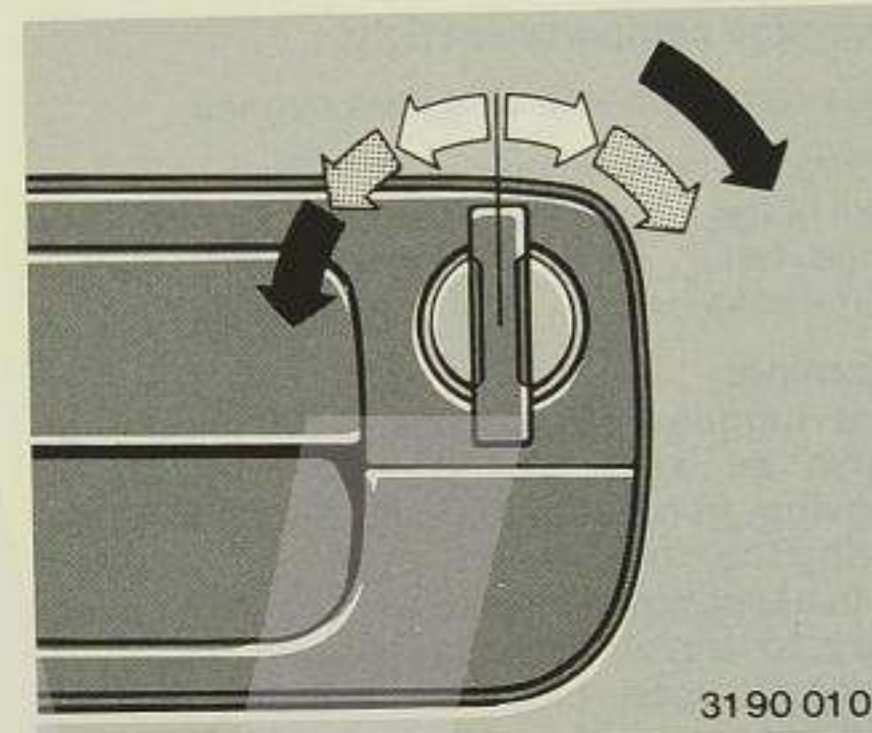

Deadlock

This is operated by either door lock.

The key can only be taken out in the vertical position.

If the deadlock is engaged, the car cannot be opened by raising the inside door lock buttons.

The vehicle immobilization system is activated at the same time, i.e. the engine cannot be started.

Warning:

Do not engage the deadlock if anyone is to remain in the car, because the doors cannot then be opened from the inside.

For further details of the anti-theft alarm system, see Page 27.

Convenient operation of the windows and sliding/vent roof by way of the door lock

Opening: when the door is closed, turn the key in the door lock to the "Release deadlock" and hold it there.

Closing: when the door is closed, turn the key to the "Engage central locking system" or "Engage deadlock" position and hold it there.

Release the key to halt the movement.

Doors

Central locking system

The doors, luggage compartment and fuel filler flap are released or locked by operating

- a door lock, or
- the lock button on either door, or
- the switch marked with a key symbol on the inside of the driver's door.

To avoid being accidentally locked out of the car

- the car cannot be locked with the lock button if the driver's door is open
- the lock button on the passenger's door only operates the central locking system if both doors are closed.

In the event of an accident, the central locking system is released automatically, and the hazard warning flashers and interior lighting are switched on.

Emergency operation
(in the event of an electrical malfunction)

Turn the key in each case until the pressure point is sensed and overcome.

Opening doors from the outside: Raise the flap handle.

Opening doors from the inside: First pull up the inside lock button, then raise the handle located above the armrest.

Warning:

The door windows are lowered slightly as the doors are opened, and run back up to the fully closed position as soon as the doors are closed. This makes it easier to open the doors, avoids damage to the rubber door seals and ensures that the glass is correctly located in the rubber door seal when the door is closed.

Note that children could lock the doors from the inside if they are alone in the car. Always take the key with you so that the car can be opened from the outside.

Driver's door lock heating

Whenever the flap handle is raised, the heating begins to operate. The heating time is regulated automatically to reduce electric power consumption.

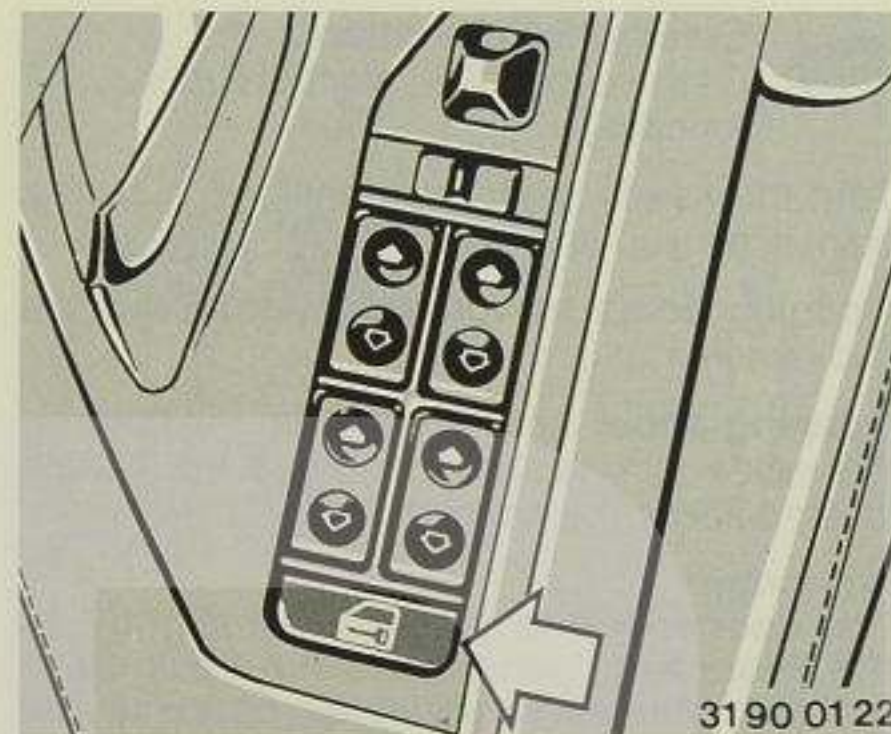

31 90 01 22

Central locking system pushbutton

This pushbutton also operates the central locking system when the driver's door is closed.

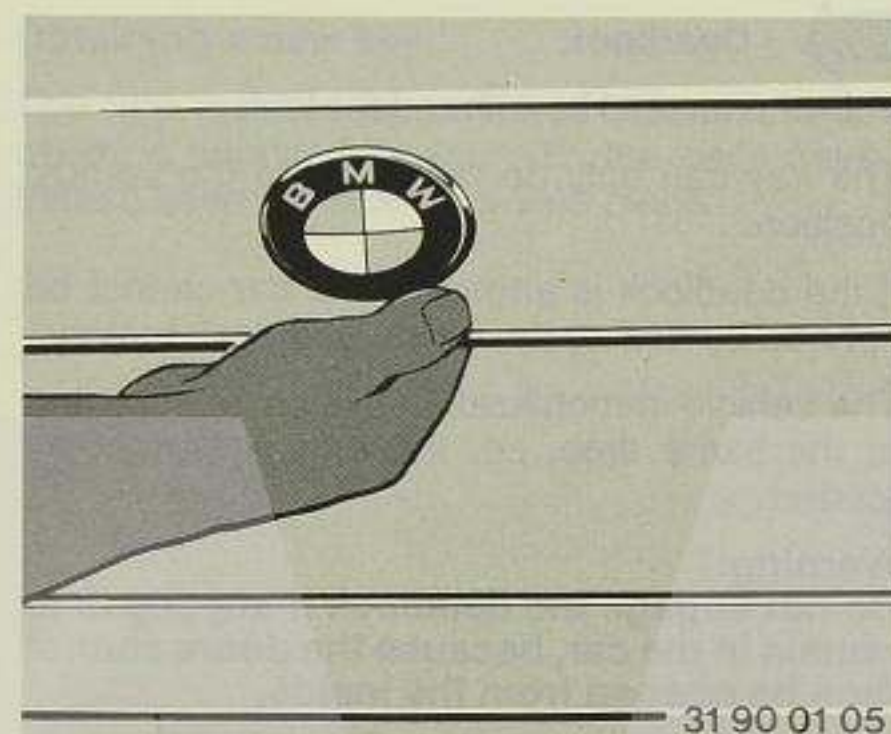

31 90 01 05

Luggage compartment

Opening:

- Release by way of the central locking system at a door lock or the lock on the glove box.
- Press the button under the BMW badge.

Manual operation in the event of a fault: see Page 100.

Closing:

- Shut the luggage compartment lid.
- Lock by way of the central locking system at a door lock or the lock on the glove box.

Nobody can gain access to the contents of the luggage compartment if the glove box is locked, even if the door and ignition key is handed over to another person. This is important, for instance at a hotel.

Luggage compartment light

This comes on when the lid is opened.

There are **lashing points** on the base and rear wall of the luggage compartment for fitting luggage nets* or tensioning straps to secure items of luggage.

Warning:

The luggage compartment lid should always be kept closed while the car is moving, to prevent exhaust fumes from entering the car.

If, in exceptional circumstances, it is necessary to travel with the luggage compartment lid open, close all windows and the sliding/vent roof and select a high airflow setting at the airflow volume selector of the automatic air conditioning system.

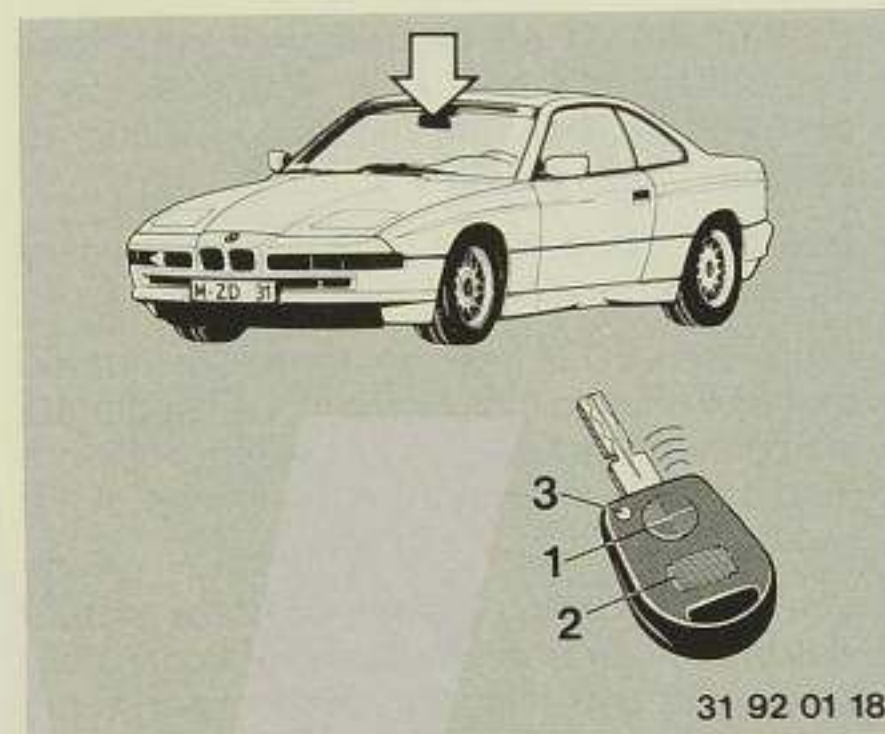

31 92 01 18

Remote control by infrared hand-held transmitter*

Point the transmitter at the receiver below the inside mirror (from a maximum distance of 5 metres). The signal path must not be obstructed.

To open: Press button 1.

- LED (3) comes on briefly
- The central locking system and deadlock are released
- The anti-theft alarm system is de-activated
- The interior lights are switched on.

Convenient opening:

To open the windows and sunroof, **keep the button pressed in**. The opening movements begin after approx. 2 seconds, and the LED flashes. Opening movements are halted immediately the button is released.

To close: Press button 1.

- The LED comes on briefly
- The central locking system is engaged.

Thiefproofing: Press button 2 not more than 15 seconds after pressing button 1.

- The LED comes on briefly
- The deadlock is engaged
- The anti-theft alarm system is activated.

To deactivate the tilt alarm sensor (see Page 27): press button 2 again briefly after engaging the thiefproofing system.

Convenient closure:

To close the windows and sunroof, **keep button 1 or 2 pressed in**. The closing movements begin after approx. 2 seconds, and the LED flashes. Closing movements are halted immediately the button is released.

Note:

If button 1 is accidentally released, it should be pressed again briefly, released and then pressed a second time and held in, to restart the desired movement.

Central key

The key blade on the infrared transmitter is a master key.

Apart from the anti-theft alarm system, all remote control functions can also be performed manually with the conventional keys (see Page 22).

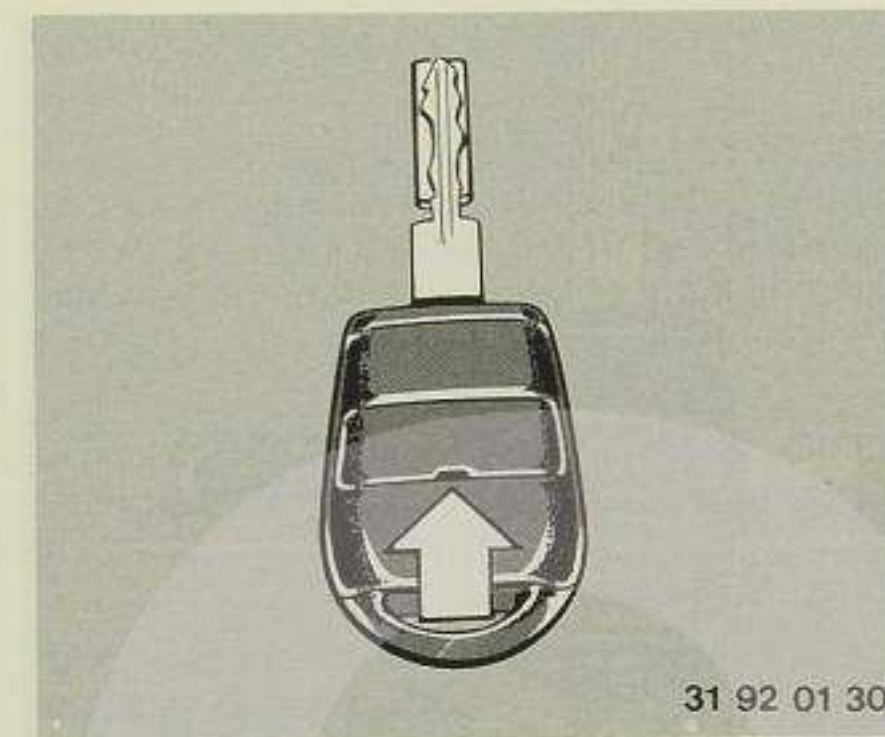

31 92 01 30

Batteries

Renew the batteries in the keys if the LED no longer comes on when a button is pressed, and the locks cannot be closed.

Lever off the cover by inserting a screwdriver blade at the cutout (arrow).

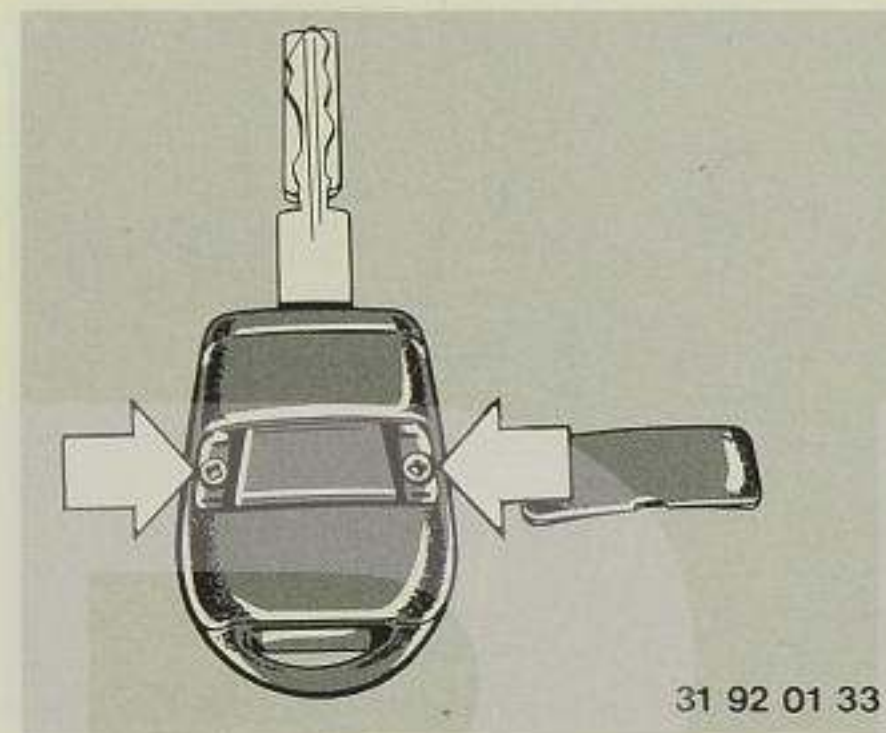

Loosen the two screws (arrows) and take off the cover.

The battery type and the correct installed position are marked on the base of the battery compartment.

Warning:
Use only batteries of the stated type.



Dispose of old batteries at an authorized collecting point or hand them back to a BMW service station.

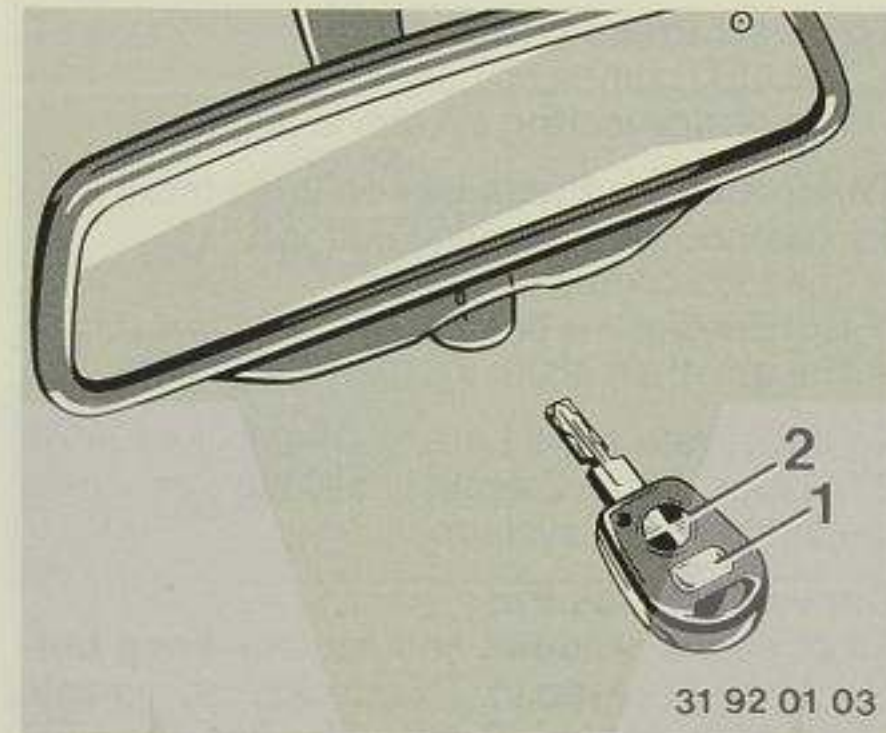

Initializing the remote control

Whenever a battery is changed, the remote-control transmitter must be initialized again (unless the battery change took less than 1 minute and none of the buttons was pressed). The same procedure must be followed if a new transmitter is brought into use (for example, to replace a lost or defective one):

- The driver's door must have been opened with the remote control.
- Close the driver's door.

Note:

If the driver's door is not closed, initializing can take place, but subsequent initializing is then inhibited until cancelled by BMW Service.

- Turn the ignition key briefly (for not more than 5 seconds) to position 1, then back to position 0.

- Press button 1 on the remote control (see illustration) and hold it in. Press button 2 briefly three times in succession within 10 seconds, while button 1 is held in.

- Release button 1; the LED will flash slowly for max. 10 seconds.

- While the LED is flashing, move the infrared transmitter up to the initializing unit under the inside mirror (as close as possible, not more than 15 cm/6 in away) and press one of the two buttons.

- The central locking system indicates that initialization has been performed successfully by closing and releasing the locks in rapid succession.

If the LED does not flash or the central locking system does not respond as described, repeat the initialization routine.

If you use additional remote control transmitters for the same car, each of them (up to four) must also be initialized within a further 30 seconds. The steering wheel lock must not be touched during this time.

If a remote control should fail, a replacement can be obtained from a BMW service station.

Note:

Every key can be copied, and in the same way the infrared signal from the remote control can itself be imitated. However, the code changes automatically each time the device is operated, and this together with the initialization process ensures maximum protection against misuse. Despite this, keep the infrared remote control in a safe place to prevent unauthorized access to it.

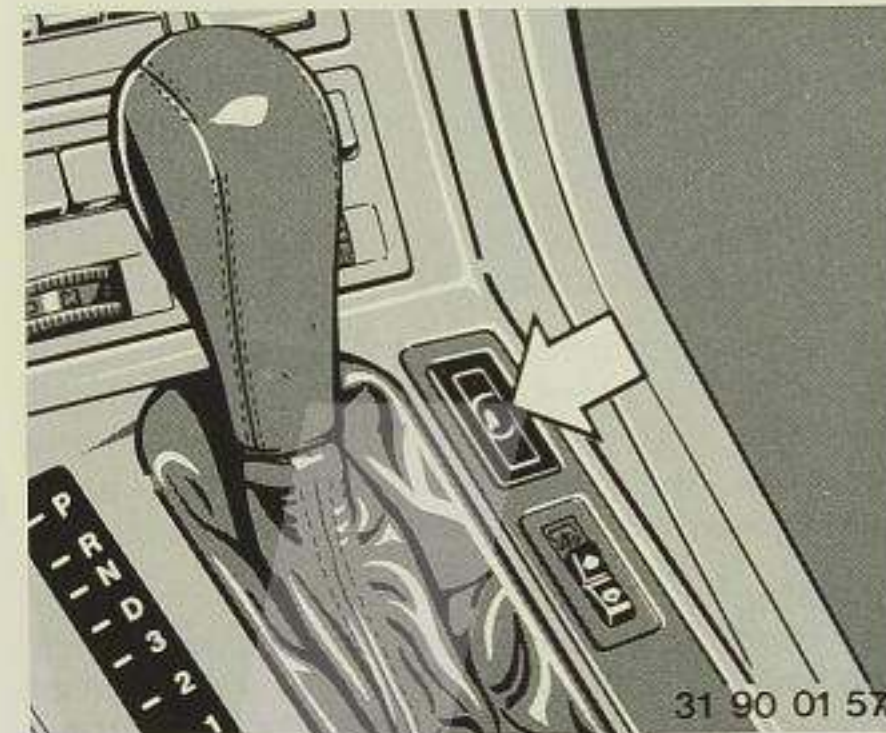

Anti-theft alarm system with additional interior protection and tilt alarm sensor*

The anti-theft alarm system reacts if:

- a door, the engine compartment or the luggage compartment is opened
- the car is pushed away
- an attempt is made to start the engine
- the radio, glove boxes or batteries are tampered with
- the rear window or a side window is broken
- the car's attitude (tilt angle) is changed, for instance if it is towed away or jacked up in order to remove the wheels.

If the car is tampered with, the alarm sounds for 30 seconds and the ignition is put out of action. At the same time, the hazard warning flashers come on for 5 minutes.

If there is any further interference with the car (e.g. attempts to start the engine, remove the radio, open the glove box or tamper with the batteries) the alarm sounds again for 30 seconds.

The system is **activated and de-activated** whenever the deadlock is operated with the remote control.

Activation is confirmed by the hazard warning flashers lighting up once only*.

When the system is correctly activated, the LED on the centre console remains on.

If the LED flashes when the system is being activated, this means that a door, the engine or luggage compartment or the glove box is not properly closed or a side window is open by more than a very small amount (app. 10 mm). Even if this situation remains uncorrected, the remaining (closed) items will be protected after 10 seconds and the LED will cease to flash and remain on.

When the system is de-activated, the LED goes out.

If an alarm signal is triggered off, the LED comes on again continuously. During de-activation, the LED flashes for 10 seconds as a sign that an attempt was made to tamper with the car.

Note:

Do not open the luggage compartment with the emergency manual release when the system is activated, or the alarm will sound.

Incorrect installation of loudspeakers in the doors can interfere with correct operation of the window protection circuits.

To prevent an unwanted alarm signal being set off by the tilt detector, for example when the car is carried on a train, this part of the system can be put out of action temporarily:

Immediately after activating the anti-theft alarm system, repeat the activating routine (in other words press remote control button 2 briefly).

The LED will come on for a short time, then come on again permanently. The tilt detector is then out of action until the entire system has been de-activated.



Note:

The convenient closure facility for windows and sunroof, operated by means of the anti-theft alarm function, should if possible remain uninterrupted.

If the procedure is broken off and restarted within the first 10 seconds, this will shut down the tilt alarm sensor unintentionally.

In this case the system must be de-activated and re-activated before the tilt alarm sensor can function again.

If normal de-activation is not possible, adopt the following procedure:

- Open the door with a key (the alarm will sound for 30 seconds).
- Get into the car, close the door and turn the ignition key to position 1 (the alarm will again sound for 30 seconds).
- Wait until the LED goes out (after app. 15 minutes). During this time, do not open any door and leave the ignition key in position 1.

The system is then de-activated, and should be examined if necessary by a BMW service station.

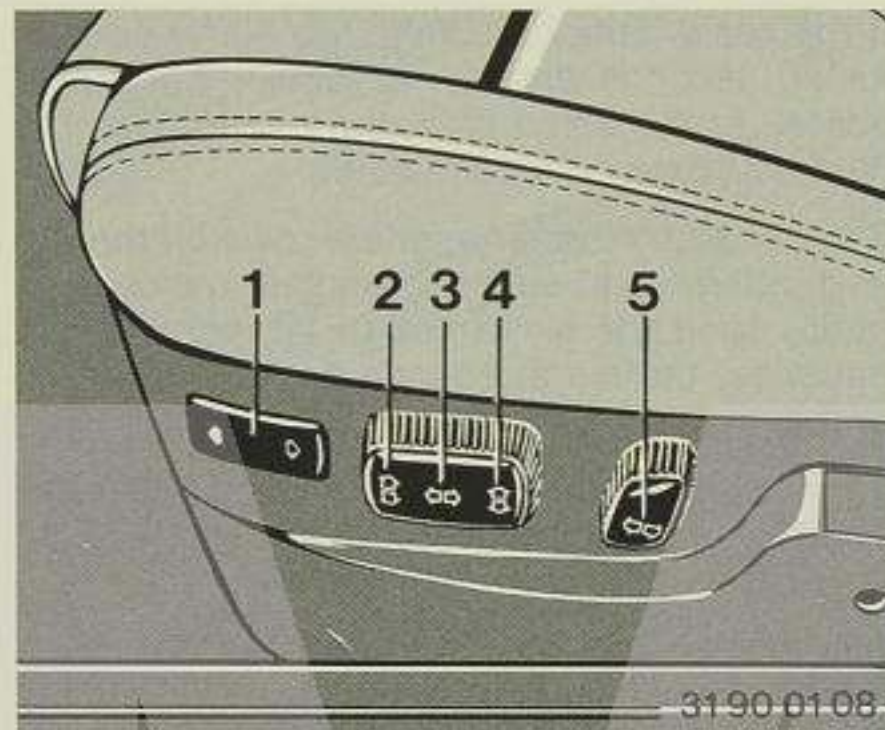
**Seats****Electric front seat position adjustment**

- 1 Rocker switch for thigh support adjustment (BMW sports seat only)

To adjust, move switch in direction of arrow:

- 2 Seat angle adjustment*
- 3 Forward-and-back adjustment
- 4 Seat height adjustment
- 5 Seat back angle adjustment

Head restraints

These are automatically adjusted in height whenever the seat height or backrest is repositioned.

Their angle can be adjusted manually.

Note:

To avoid strain on the spinal discs, sit well back so that you are fully supported by the seat back.

The ideal position is when the head is a straight-line extension of the backbone.

On a long journey, the seat back can be inclined slightly more, to reduce muscular strain. However, you should still be able to reach any point on the steering wheel with the arms slightly bent.

Warning:

For the following reasons, it is essential for the belt not to be worn slack: in the event of a head-on collision, the lap belt could otherwise slide over the hips and injure the lower part of the body. Furthermore, excessive belt slack delays the restraining action. Do not reposition the driver's seat while the car is in motion. A sudden seat movement could cause you to lose control of the car and result in an accident. Nor should the front passenger's seat be fully reclined while the car is being driven.

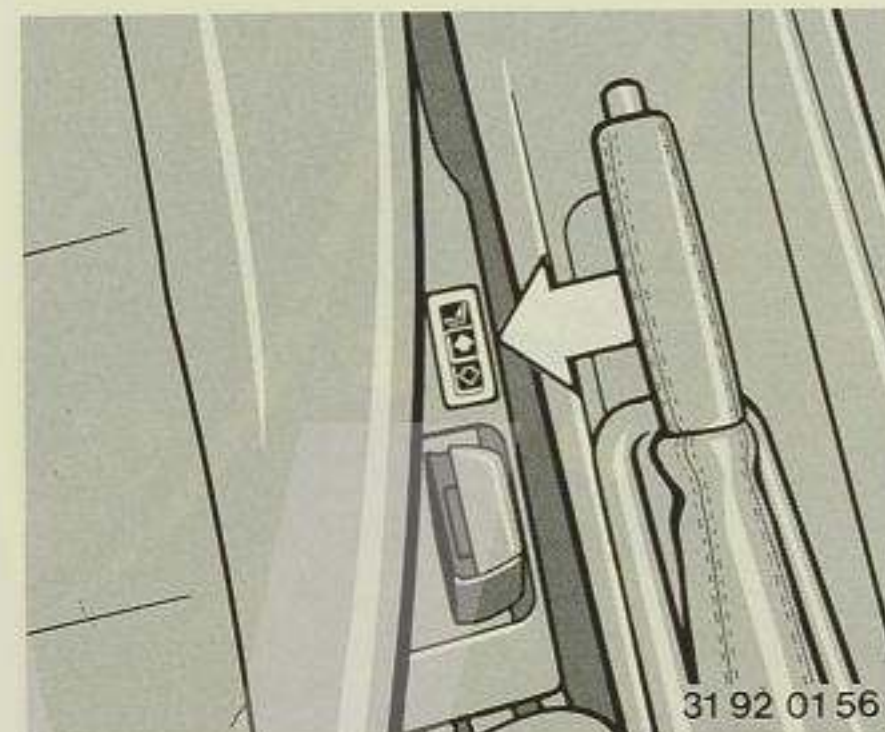
**Lumbar support***

The seat back contour can be altered to provide more support to the curved (lumbar) section of the spine.

The upper rim of the pelvis and the spinal column are supported, to encourage an upright but relaxed seated position.

Press the switch forwards to increase the curvature of the support.

Press the switch backwards to reduce the curvature of the support.

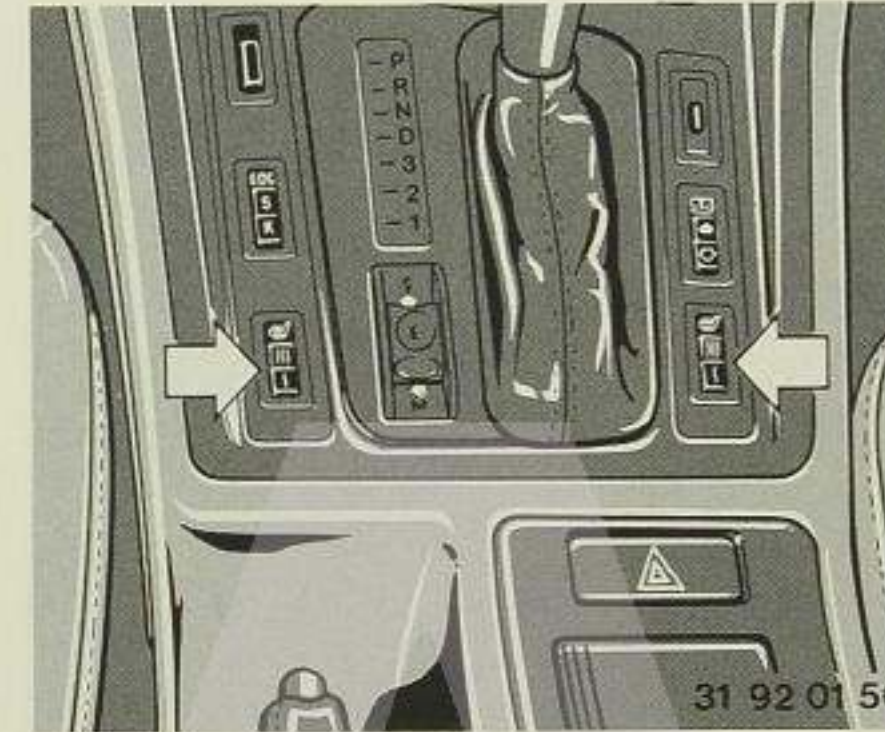
**Seat heating***

The seat base cushion and the seat back can be heated when the engine is running.

Press the desired symbol on the switch:

- ⏏ Rapid heating while the symbol is illuminated. Automatic changeover to regular heating.
- ⏏ Regular heating. Cuts out automatically when the switch is no longer illuminated.

To switch over while heating: press the non-illuminated section of the switch.

To switch off prematurely: press the illuminated section of the switch.

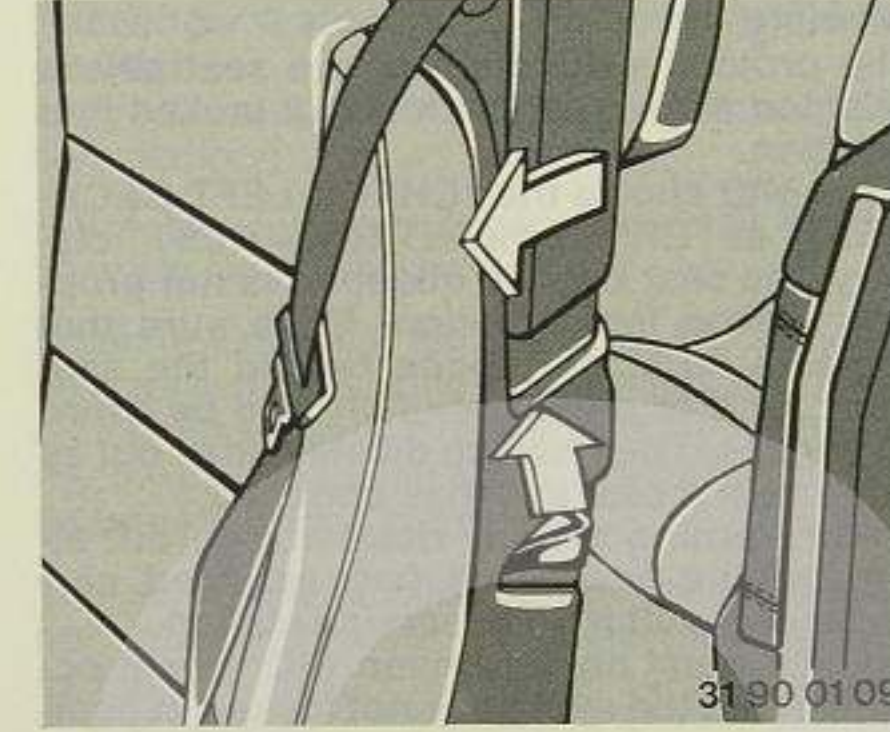
**Seat back release**

Press the lever up and pivot the seat back forwards.



Warning:

The protective function of the seat belt is affected if the seat back is not locked into position.

If the MID shows the "CHECK LEFT BACKREST" or "CHECK RIGHT BACKREST" display, the seat back in question is not properly locked into position. Make sure that there is sufficient space behind the seat back for it to pivot back fully and be heard to engage. The warning display goes out as soon as the seat lock has engaged.

If the warning display does not go out although the seat back has engaged correctly, consult a BMW service station.

The car must not be driven with a seat occupied but the seat back not locked in position.

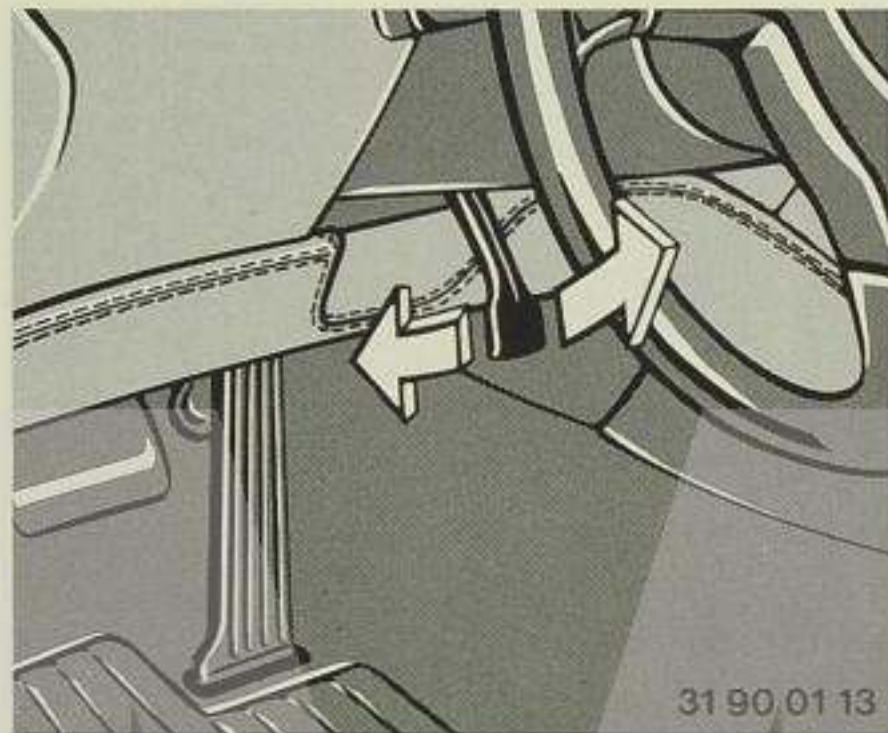
**Steering column adjustment**

- Fold out the adjusting lever.
- Push or pull the steering wheel until the desired reach position is obtained.
- Fold the lever back in to clamp the steering column in the new position.

Warning:

Adjusting the position of the steering column while the car is being driven represents an accident risk.

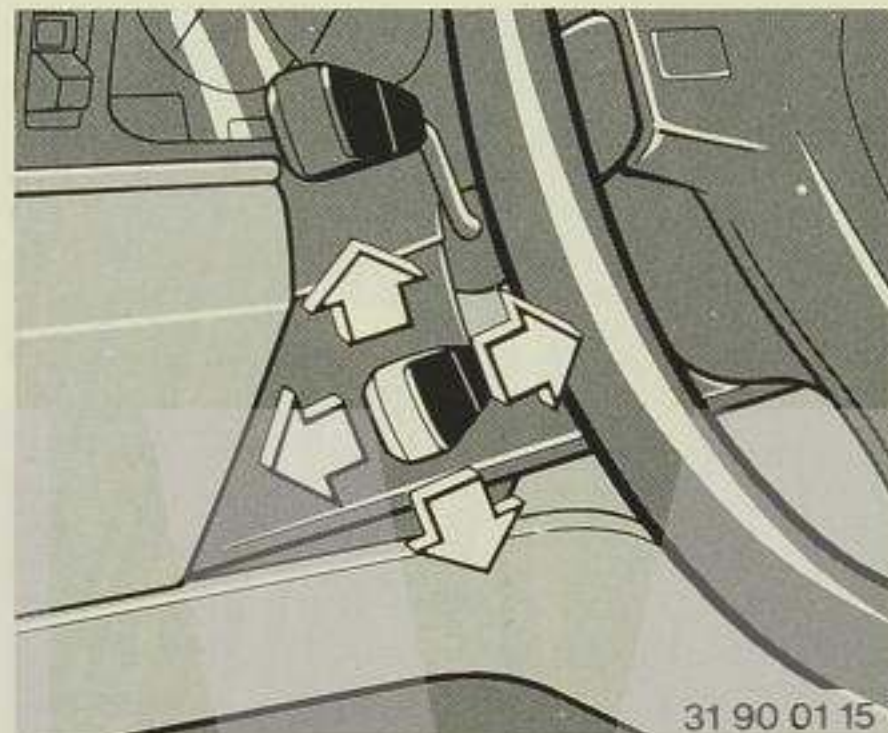
**Electric steering wheel adjustment***

The steering wheel can be adjusted in four directions, which are simulated by the adjusting lever movements.

Warning:

Adjusting the position of the steering column while the car is being driven represents an accident risk.

For memorizing of the steering wheel position, see "Seat, mirror and steering wheel position memory", Page 33.

Automatic steering wheel adjustment*

(only in conjunction with seat, mirror and steering wheel position memory)

To simplify entering and leaving the driver's seat, the steering wheel moves automatically to its uppermost position when:

- the ignition key is turned to position 0
- the ignition key is in position 1 and the driver's door is opened
- the ignition key is in position 2, the handbrake is applied and the driver's door is opened.

The steering wheel returns to the driving (memorized) position when:

- the ignition key is in position 2 and the handbrake is released with the driver's door open
- the ignition key is in position 2, the handbrake is applied and the driver's door is closed.

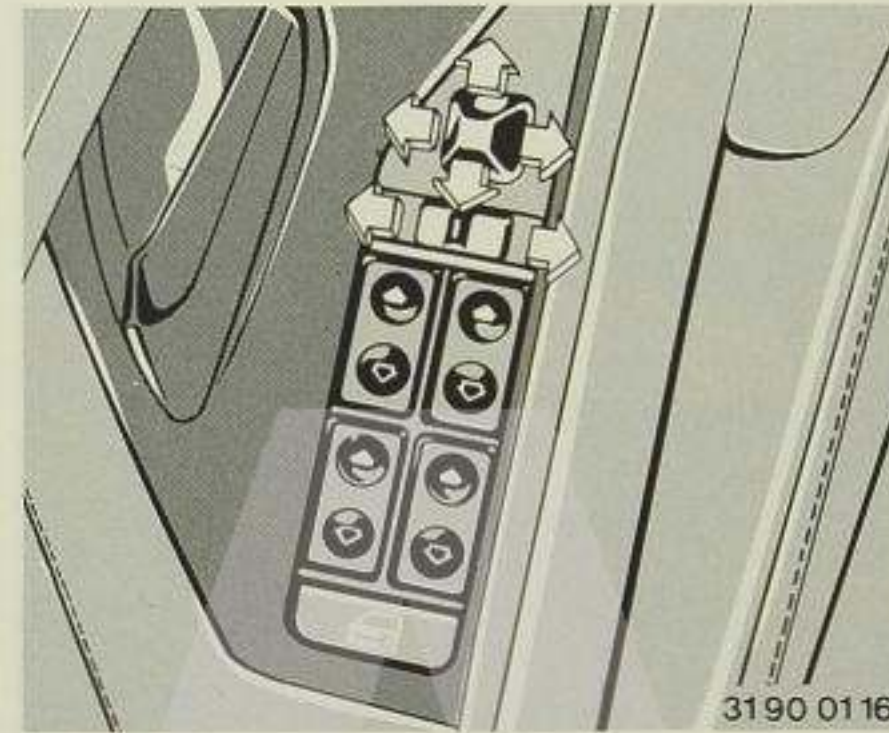
**Mirrors****Electric door mirrors**

These can be adjusted in four directions with the mirror control switch.

Changeover switch for the other mirror:

Move switch to left for driver's mirror.

Move switch to right for passenger's mirror.

The mirrors can also be adjusted manually by pressing the edge of the glass.

For memorizing mirror positions, see "Seat, mirror and steering wheel position memory", Page 33.

Passenger's side mirror tilt-down (parking) position

(only with seat, mirror and steering wheel position memory)

Move the mirror changeover switch to the "Driver's side" position.

When reverse gear (or automatic transmission selector lever position R) is selected, the mirror on the passenger's side will tilt down slightly to display the ground along the side of the car (for instance the edge of the kerb).

This automatic function can be switched off if not required: move the mirror changeover switch to the "Front passenger's side" position.

Aspherical wide-angle mirror*

The outer section is of aspherical convex pattern, to provide a larger field of view than the normal inner section of the mirror.

This extends the driver's rearward field of view and eliminates the "blind spot".

Warning:

The passenger's side mirror is convex (on the BMW 850CSi, both outside mirrors are convex) and therefore makes reflected objects seem closer than they really are. It can be difficult to estimate the precise distance at which another vehicle is following your car. The same applies to the convex section of partly-convex aspherical wide-angle mirrors.

Electric mirror heating

Both outside mirrors are automatically heated (controlled heat output) in ignition key position 2.

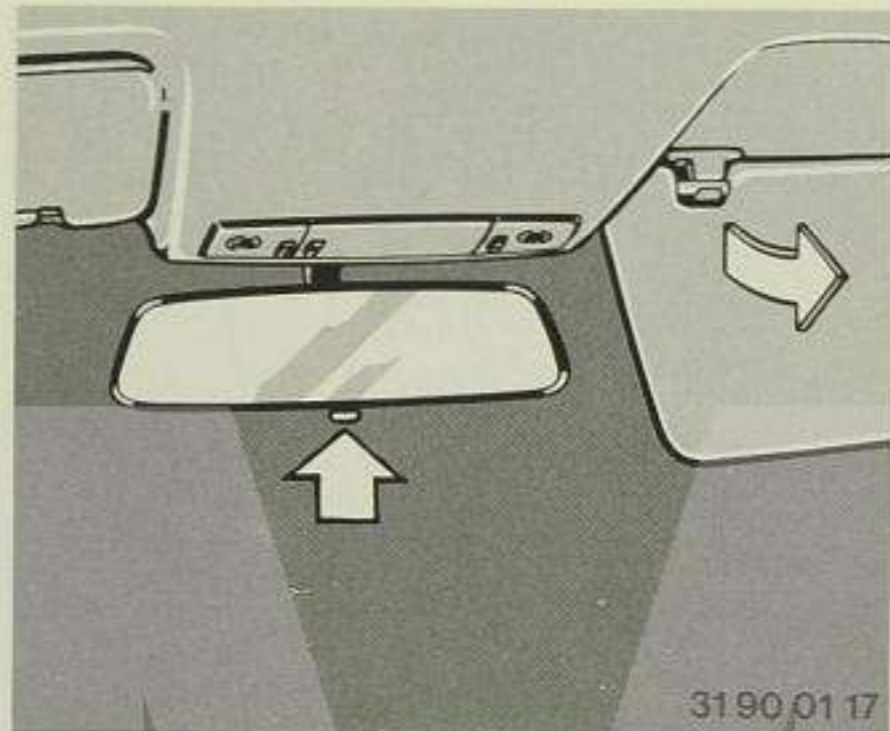

3190 01 17



31 92 01 29

Inside mirror

To reduce glare from the headlights of following vehicles after dark, move the small lever to tilt the mirror.

Make-up mirrors

Fold the sun visor down and slide the mirror cover sideways.

The mirrors are illuminated when the car's outside lights are switched on.

Sun visors

The sun visors can be pivoted to the side, in front of the door windows.

Automatic anti-glare inside mirror (electrochrome)*

Rotary knob in position 0: automatic anti-glare function out of action.

Rotary knob in position 1: the mirror dims automatically and continuously when light strikes it (from the surrounding area as well as other vehicles' headlights).

When reverse gear is selected, the mirror reverts from either position to the clear-glass (non-dimmed) setting.

Note:

The mirror will not operate reliably unless the photo-electric cells are kept clean and are not obstructed.

Non-automatic anti-glare inside mirror
(only in conjunction with infrared remote control)

Rotary knob in position 0: normal mirror position.

Rotary knob in position 1: anti-glare mirror position.

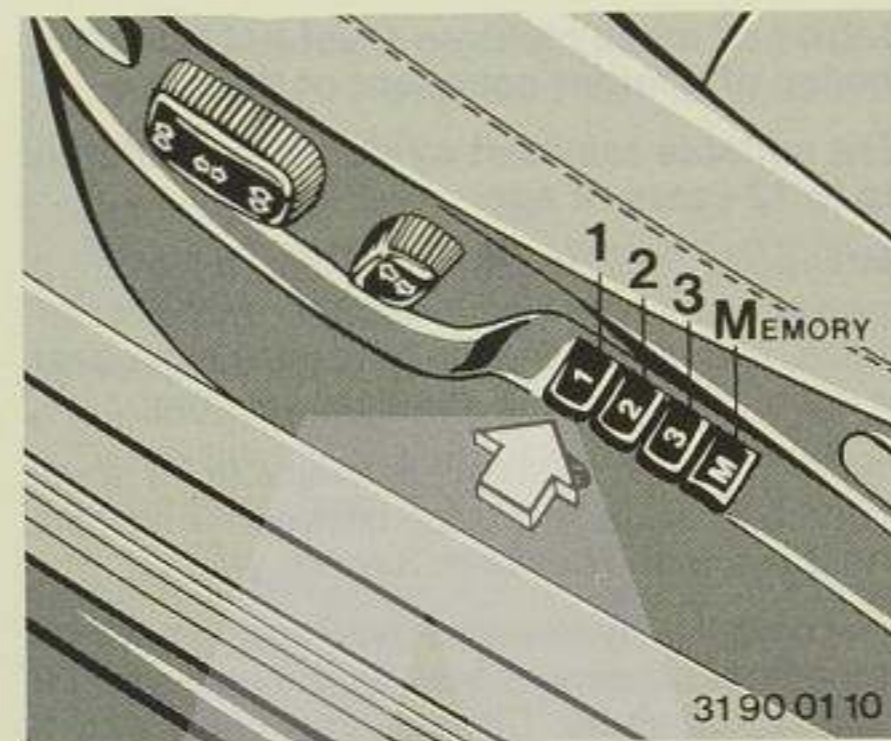

3190 01 10

Seat, mirror and steering wheel memory*

Three different seat, outside mirror and (only with electric steering wheel adjustment) steering wheel positions can be memorized.

Memorizing:

- Ignition key must be in position 1 or 2.
- Select the desired seat, outside mirror or steering wheel position.
- Press the MEMORY button: The telltale lamp in the button comes on.
- Press button 1, 2 or 3 as required in the direction of the arrow: the telltale lamp goes out.

Recall:

- Keep button 1, 2 or 3 (whichever was used to store the position settings) pressed until the new positions have been reached.



3190 01 14

Seat belts

Wear the seat belts whenever the car is driven.

You do not have to adjust the front seat belt manually. The seat-integrated belt system resets itself automatically to suit wearers of different sizes.

Fastening the belt:

The seat belt catch must be heard to snap closed.

Releasing the belt:

Press the red release button on the belt catch and guide the belt back if necessary to reinforce the action of the automatic reel.



For your own safety, please note:

The belts must be close to the upper and lower parts of the body and should not be twisted. They should not pass over hard or fragile objects in your pockets.

The seat belt must not pass across the neck, become trapped at any point or chafe against any sharp edges.

The belt should be as close to the body as possible, therefore avoid wearing thick and heavy clothing.

Take up slack regularly by pulling up the belt at the shoulder.

Warning:

For the following reasons, it is essential for the belt not to be worn slack: in the event of a head-on collision, the lap belt could otherwise slide over the hips and injure the lower part of the body. Furthermore, excessive belt slack delays the restraining action.

Pregnant women are also advised to wear the seat belt at all times, making sure that the lap belt is low down over the hips and does not press against the abdomen.

Never restrain more than one person with each seat belt.

Babies or small children must not travel on the lap of another occupant of the car.

Use suitable restraint systems for children up to 12 years of age.

Babies up to 9 months old can travel in a special shell-type baby carrier facing rearwards, and secured to the front passenger seat or the rear seat by the standard seat belt.

The BMW Vario System* is available for small children in the age-groups between 9 months and 3 years and between 3 and 6 years.

Attachment is by means of two locking catches to the front passenger seat for the age-group 9 months to 3 years. Children between 3 and 6 years of age use the BMW Vario System facing forwards on the rear seat, and secured by the standard seat belt.

A further three-element child's seat, comprising seat shell, seat back and restraining section, is generally available for the age-group from 2 to 12.

This too is installed facing forwards on the rear seat, and secured by the standard seat belt.

Whenever a child restraint system is used, its manufacturer's instructions must be complied with. The necessary rear-seat anchorage points are provided as a standard feature.

Warning:

Child restraint systems are not to be attached to the front passenger seat of cars with a passenger airbag.

In no circumstances are seat-belt or child restraint systems to be modified.

If any damage or excessive loads are incurred in an accident, a BMW service station must renew the seat-integrated belt system and/or **BMW child restraint systems*** and check the belt anchorages.

The seat belt reel locks:

- if pulled out rapidly
- during sudden braking or accelerating
- when the car is cornered sharply
- when the car is tilted at a considerable angle.

Note:

Drivers should ensure that their passengers also comply with the relevant requirements and instructions concerning seat belts.

For **care of belts**, see Page 127.

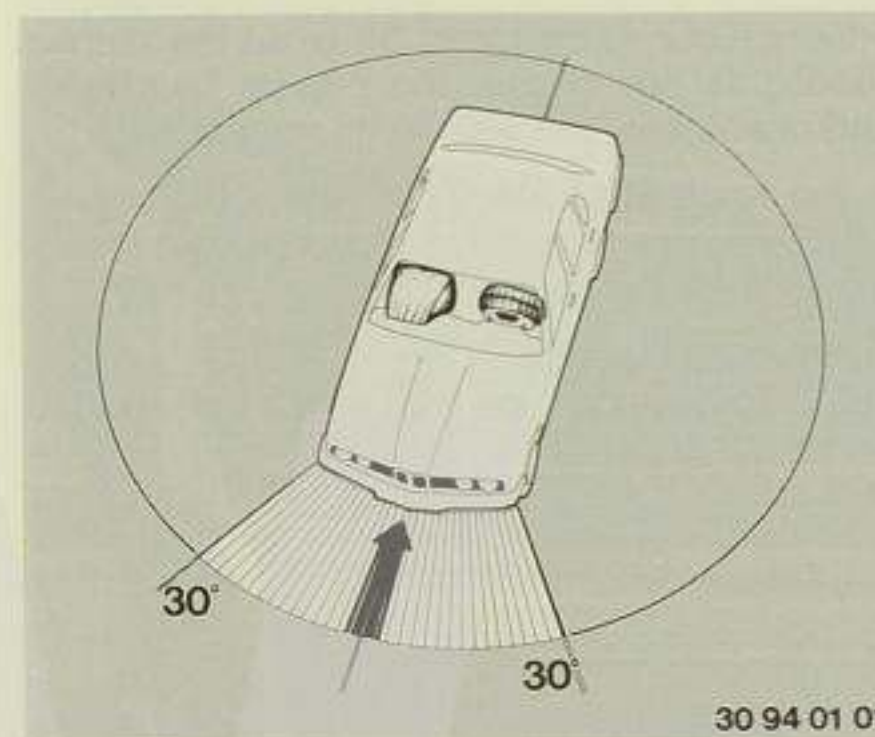
**Airbag restraint systems**

- Driver's airbag*
- Front passenger's airbag*

The airbag restraint systems protect the driver/front passenger in a head-on collision. The inflated airbag restrains forward movement of the seat occupant and protects his or her head and upper body against injury.

The picture shows the area within which the airbag restraint system is triggered off.

In less severe accidents and if the car rolls over, is sideswiped or struck from the rear, protection is provided by the seat belt alone.

Warning:

The airbag is an additional safety device. It must not be regarded as an alternative to wearing the seat belt.

AIRBAG telltale light on instrument panel or in sports steering wheel*:

This telltale confirms that the system is in working order when the ignition key is turned to position 1 or beyond.

System operational:

- The telltale comes on for about 6 seconds or 2 seconds* and then goes out.

System defective:

- The telltale does not come on.
- The telltale comes on for about 6 seconds or 2 seconds*, goes out briefly and then comes on again.
- The telltale flashes for 5 minutes during a journey, then remains on permanently.
- The telltale remains on permanently* while driving or flickers*.

In these cases there is a risk that the system will not be triggered off even if a sufficiently severe accident occurs.

Please have it checked by a BMW service station without delay.

What happens when the system is triggered off?

The airbags, which are concealed under the flaps in the steering wheel or in the fascia, are inflated rapidly and burst out of the preformed aperture in the padded covers.

The entire process takes place with great force, within only a twentieth of a second.

* With airbag restraint system fitted in the sports steering wheel

In view of the very brief system response time, the noise of propellant ignition, inflation and subsequent deflation is lost in the general accident situation.

Propellant gas and small quantities of gaseous fumes are released when the airbag is triggered off. They do not represent a health hazard or imply that the car has caught fire.

The sudden increase in pressure inside the car when airbags are inflated may temporarily impair the occupants' hearing.

Warning:

Your seated position should be as far as convenient from the steering wheel or fascia.

Always hold the steering wheel by its rim. Failure to drive in this manner could result in hand or arm injuries if the airbag operates.

No objects should be held or allowed to rest between the airbag and the seat occupant's body.

Even if all the appropriate precautions are taken, the risk of facial injuries when airbags are triggered off cannot be entirely ruled out in all accident situations.

Airbag safety instructions

No modifications to individual components or to the wiring should be attempted. This includes the padded cover in the centre of the steering wheel and the cover on the fascia, which must never be covered with adhesive tape, sheet or any other material or otherwise modified or reworked in any way. The steering wheel itself must not be taken off.

After the airbag has been triggered off, all its components must be renewed.

All work on the airbag system must be carried out by a BMW service station.

Any careless or unskilled interference with the system could lead to its failure or to accidental triggering off with the risk of injury.

If an airbag generator has to be scrapped, the safety precautions issued by BMW must always be complied with. They can be studied at any BMW service station.

Child restraint systems mounted on the front passenger's seat are not permitted on cars with a front-passenger airbag. In certain countries it is in any case required by law that children under the age of 12 should only travel on the rear seats.

Note:

Drivers of cars fitted with airbags should ensure that their passengers also comply with the relevant requirements and instructions.

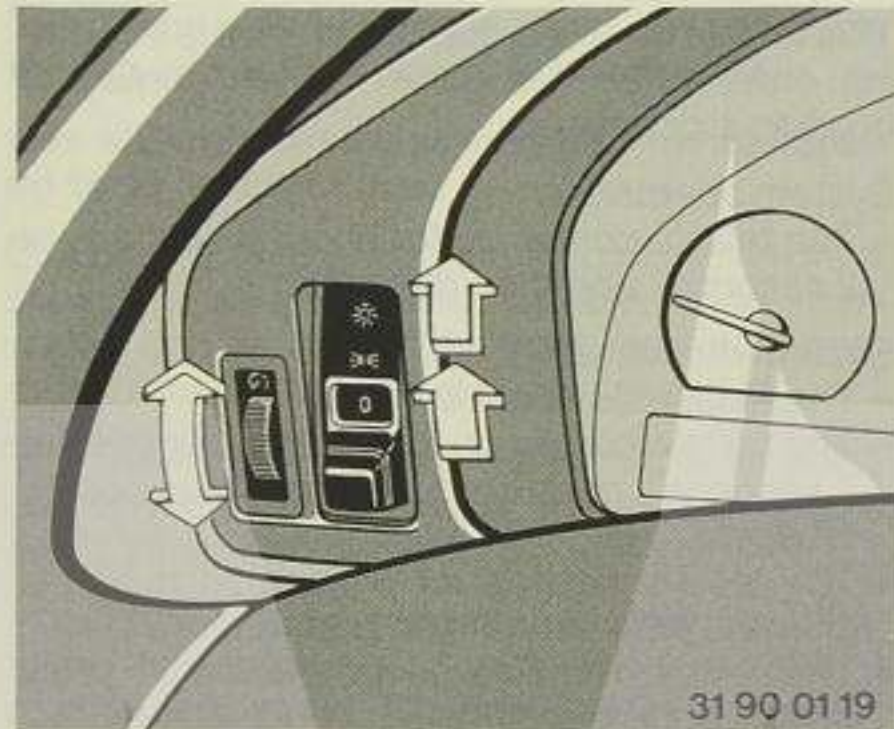

31 90 01 19

Main light switch

Daytime lights setting*

If desired, the light switch can remain in this position: when the ignition is turned off, the car's lights go out.

On vehicles fitted with the daytime lights setting*, the daytime lights come on automatically in ignition key position 2 if this switch setting is not used, even if the light switch is at 0.

Side lights

Dipped headlights – in ignition key position 2 only. The pop-up headlights are extended.

If the ignition is switched off while the dipped headlights are in use, the pop-up headlights retract and only the side lights remain on.

In the event of an electrical defect, the pop-up headlights can be extended or retracted manually. See Page 101.

Instrument lighting

The intensity can be varied at the knurled wheel.

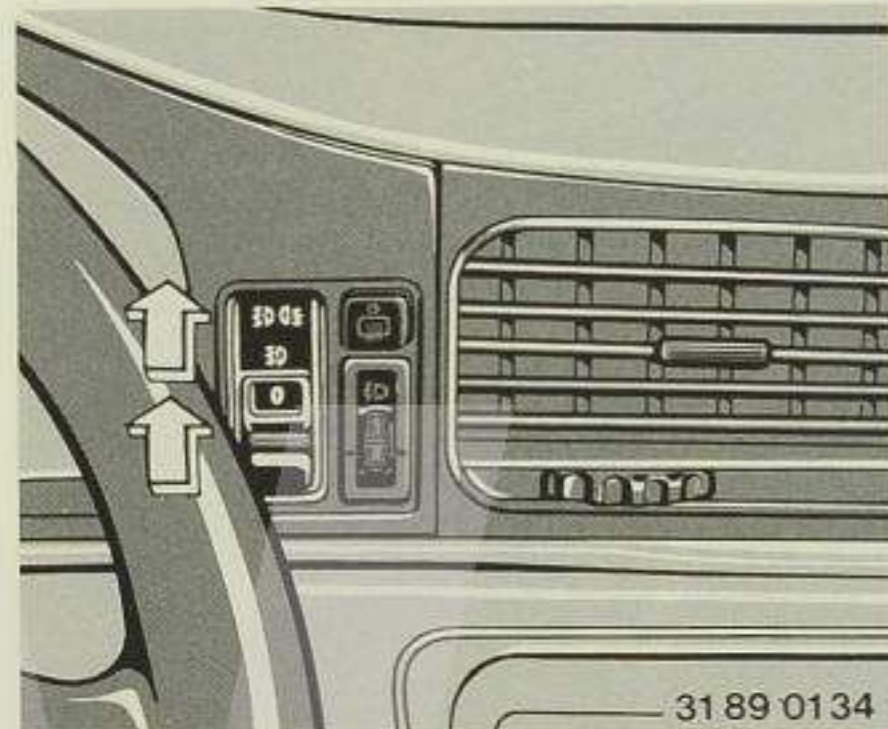

31 89 01 34

Fog light switch

Front fog lights

The green telltale light on the instrument panel comes on when the fog lights are in use. The pop-up headlight units are extended.

Front and rear fog lights

The yellow telltale light on the instrument panel comes on additionally when the rear fog lights are in use.

Please comply with local legislation concerning the use of front and rear fog lights.

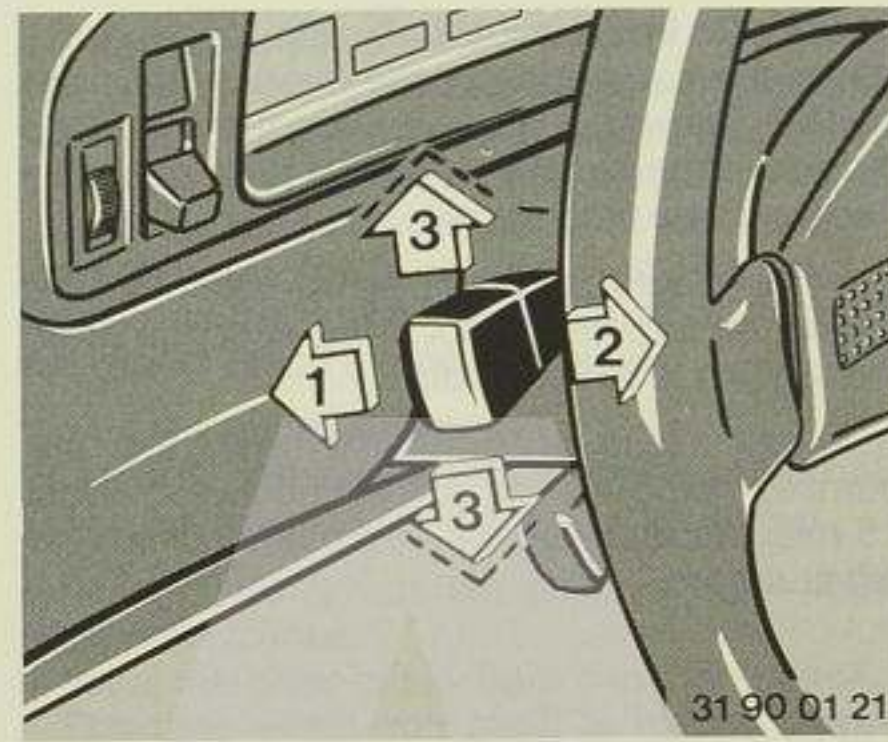

31 90 01 21

Lever for flashing turn indicators/dipped headlights

- 1 High headlight beams (blue telltale light)
- 2 Headlight flasher
- 3 Turn indicator repeater (green telltale lights, flasher relay ticks rhythmically).

If the repeater flashes and the relay ticks more rapidly than usual, a turn indicator bulb has blown.

To indicate a turn briefly

When starting from a standstill or changing lanes, for instance, a signal can be given by moving the lever without allowing it to engage in the turn signal position. When it is released, it returns automatically to the central (Off) position.

Right or left parking lights

When the steering lock is engaged, press the lever beyond the normal turn indicating position until it reaches a detent.

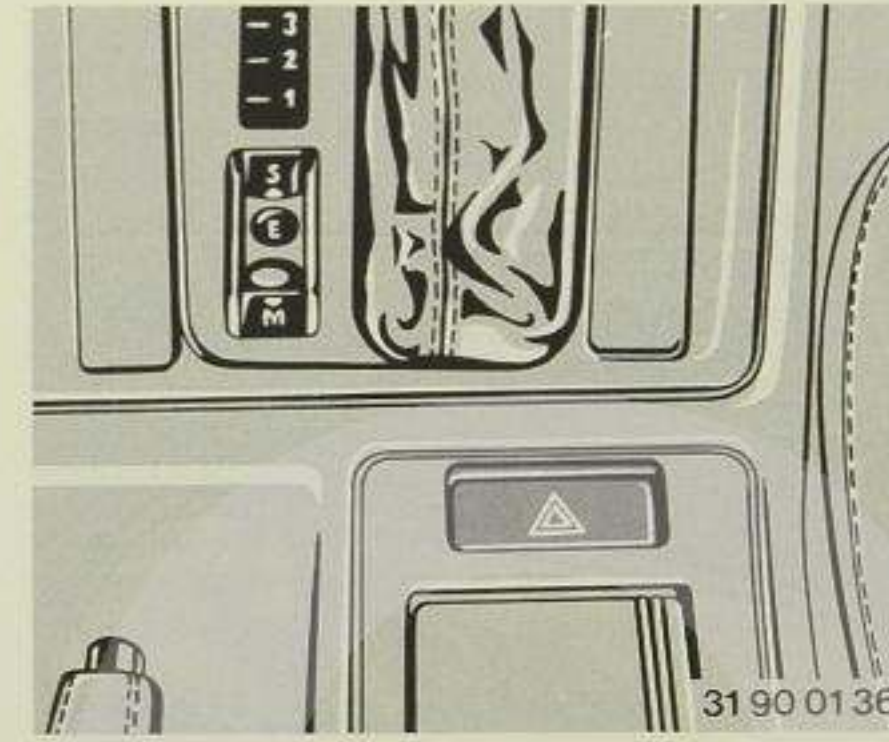

31 90 01 36

Hazard warning flashers

The pushbutton lights up in a regular rhythm when the hazard warning flashers are operating.

The pushbutton is illuminated when the car's outside lights are on.



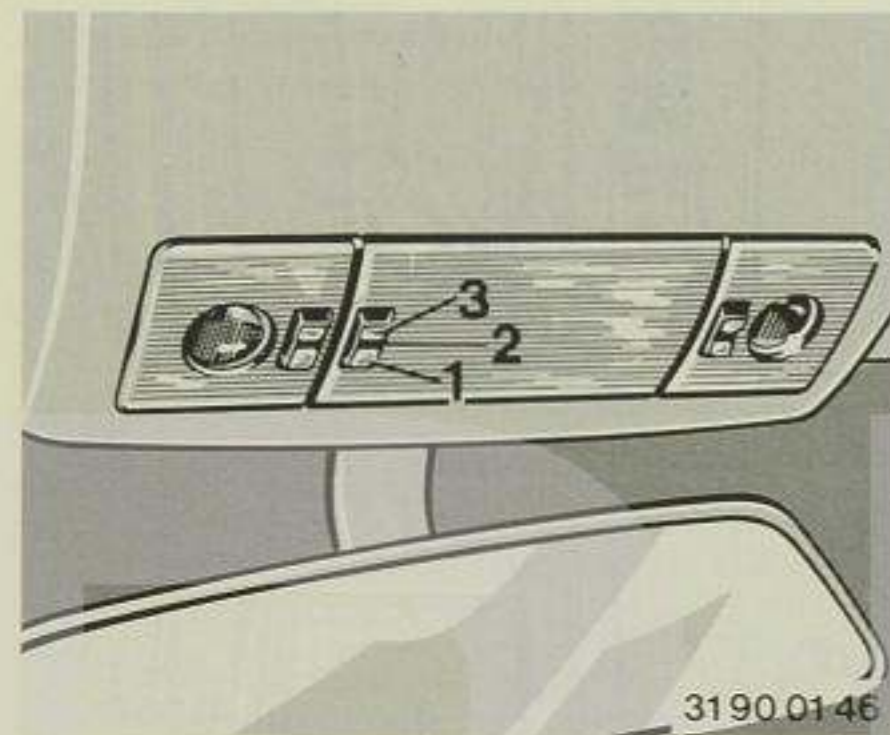

3190 01 46

Automatic interior light circuit

When the car is locked, the interior lights are switched on for a few seconds if the driver's outside door handle is raised (this can only happen three times in all).

If the car's outside lights were switched on, the interior lights come on for a few seconds when the ignition is switched off.

A safety circuit ensures that any lights still burning inside the car are extinguished about 15 minutes after the car has been locked and left parked.

Interior lighting/footwell lights*

- 1 The lights come on:
 - When a door is opened (courtesy switches at doors)
 - For a few seconds after the doors have been closed and the ignition is switched off, or until the ignition is switched on
 - After an accident.
- 2 Lights permanently off.
- 3 Lights permanently on.

The reading lights next to the front interior light are wired similarly.

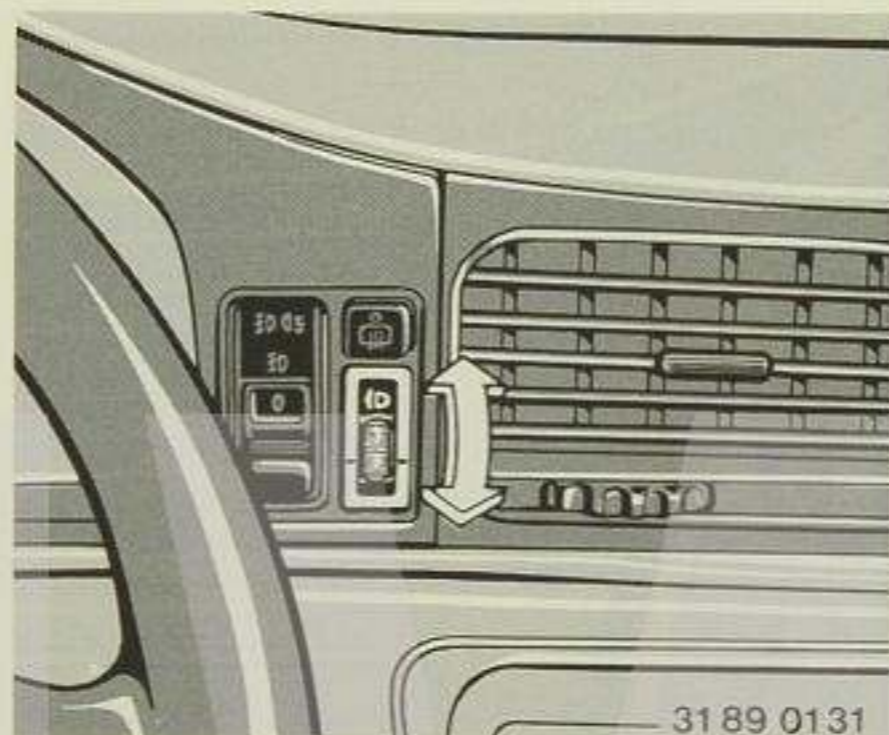

3189 0131

Beam throw adjustment*

The low (dipped) headlight beams can be adjusted to allow for changes in the load on the car.

- 0 = 1 - 2 persons, no luggage
- 1 = 4 persons, with or without luggage
- 2 = 1 person, luggage compartment full

Note the permitted rear-axle load limit.

If the dipped headlight beams are very low, this indicates a fault in the beam throw adjustment system.

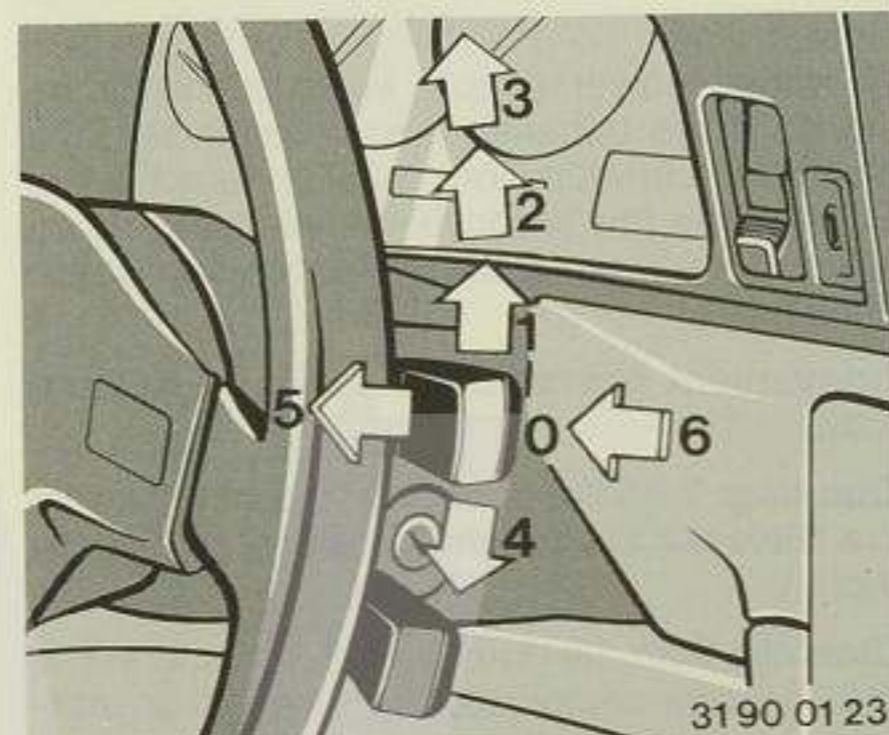

3190 01 23

Wipe/wash equipment

- 0 Parked position of wipers
- 1 Intermittent wipe
- 2 Normal wiper speed
- 3 Fast wiper speed
- 4 Flick wipe
- 5 Automatic windscreen wash
- 6 Automatic intensive cleaning

0 - Parked wiper position

The wipers are partly concealed behind the rear edge of the engine compartment lid. In order to swing the wipers up vertically, for instance to renew the blades or at sub-zero temperatures, lever position 1 should be selected and the ignition switched off as soon as the wipers reach the new position.

1 - Intermittent wipe

The length of the interval is varied automatically according to the car's actual road speed.

However, the driver can also vary the wipe interval as follows:

- Move the lever briefly from 0 to 1 and back.
- The time which you allow to elapse before switching on again (from 0 to 1) is the subsequent intermittent-wipe interval (maximum 25 seconds).

This interval setting is cancelled if you return the lever to 0 or when the ignition is switched off.

2 - Normal wiper speed

If the car comes to a standstill, the wipers are reset to intermittent operation if this speed is selected, until the car restarts.

3 - Fast wiper speed

If the car comes to a standstill, the wipers are reset to the normal speed until the car restarts.

5 - Automatic windscreen wash

Fluid from the washer tank is sprayed on to the windscreen and the wipers operated briefly. (Exception: when the lever is pulled **briefly**, washer fluid is sprayed onto the windscreen without the wipers being operated.)

6 - Automatic intensive cleaning

Same as 5, but intensive cleaning fluid is first sprayed on to the windscreen.

Headlight cleaning system*

If the pop-up headlights are extended, they are automatically cleaned as well on each fifth occasion the windscreen is cleaned by functions 5 or 6.

Note:

Do not use the washer systems if there is any risk of the liquid freezing to the windscreen. This could interfere with the driver's view of the road.

Do not run the washer system if the fluid reservoir is empty, or else the washer pump will be damaged.

Heating the windscreen washer jets

This takes place automatically in ignition key position 2.



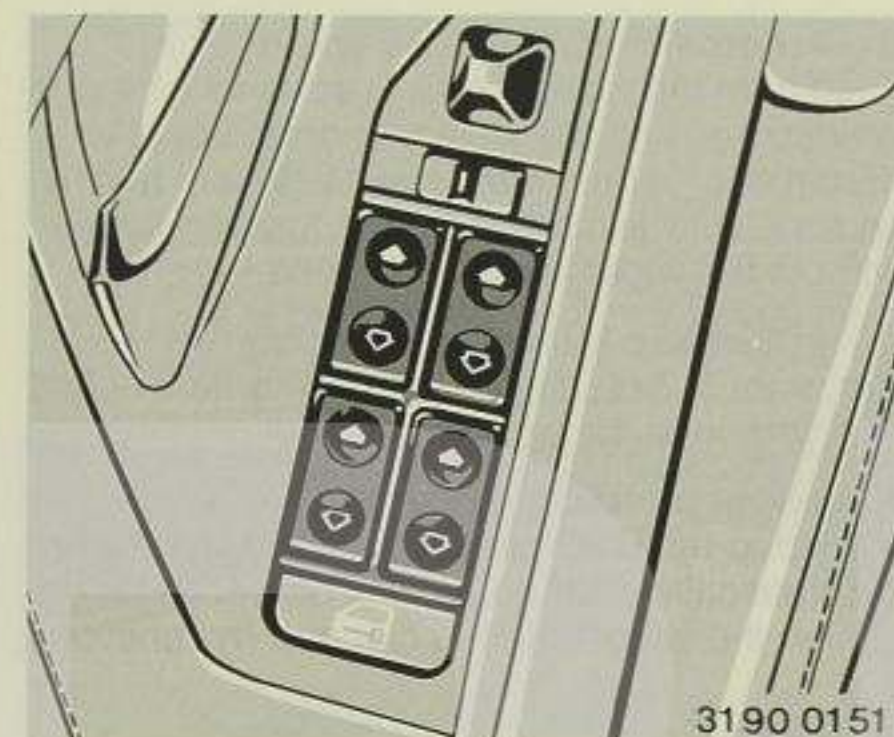

3190 0151

Electric windows

These can be operated in ignition key position 2.

- Press the rocker switch in until the pressure point is felt. The window will continue moving until the rocker switch is released.
- Press the rocker switch in briefly beyond the pressure point (one-touch function*). The window opens or shuts automatically. In this case, window movement is halted by touching the switch again briefly. The one-touch function applies to opening and closing the door windows, but only to opening the rear side windows.

There is a separate rocker switch on the passenger's side.

After the ignition has been switched off, the electric windows can still be operated

- in ignition key position 0 or
- with the key removed and also
- if the doors have only been opened once.

Protective function

If a door window encounters an obstruction while closing at a point above approximately half the total vertical movement, the glass will come to a halt and then re-open slightly.

This protective function can be put out of action (for instance if the window moves stiffly in frosty weather) by holding down the one-touch function.

The system is also protected against overloads and malfunctions by an automatic electronic circuit breaker.

Warning:

If a door window is open when the car reaches a speed of app. 150 km/h, it will close automatically to keep the noise level low. However, if the window is then re-opened, this function is put out of action for this particular window until the engine is re-started.

Note:

After any power supply interruption, for instance if the batteries are disconnected, the electric window functions must be re-activated: Either close the windows completely or, if already closed, press the corresponding switch once briefly.

Convenient operation of windows at door lock

Opening: With the door closed, turn the key to the "Release thiefproofing position" and hold it there.

Closing: With the door closed, turn the key to the "Engage central locking system" or "Activate deadlock" position and hold it there.

Releasing the key halts the window movement.

For convenient operation of windows by means of the remote control, see Page 25.

Warning:

Careless or unsupervised closure of the windows could cause injury. Make quite sure that children cannot operate the switches accidentally, by taking the ignition key with you when you leave the car.

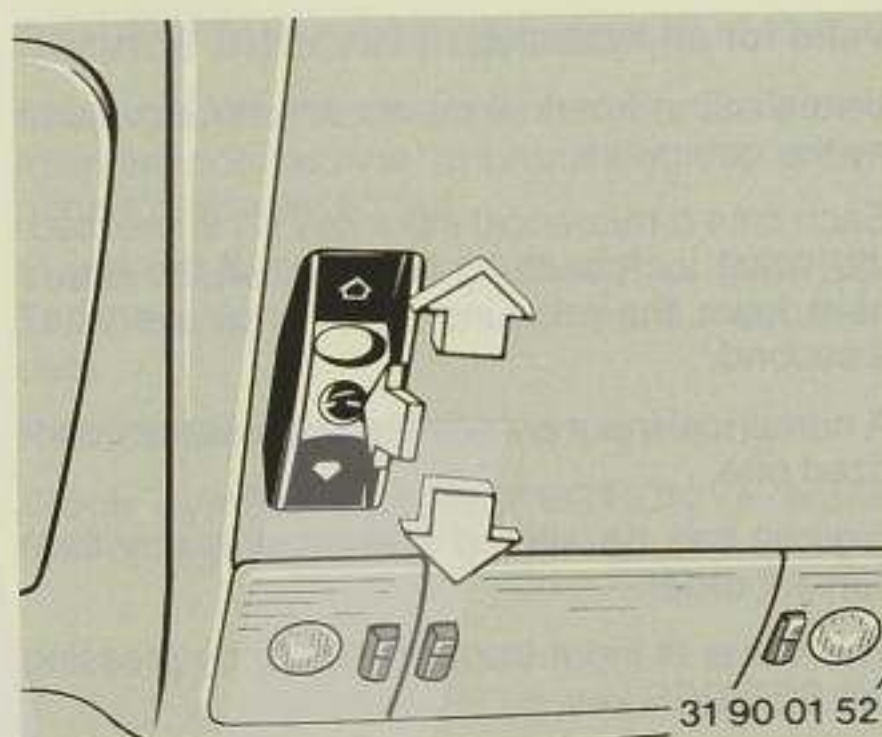

31 90 01 52

Sunroof*

Can be operated in ignition key position 2.

To raise: Press the switch.

To open: Slide the switch to the rear.

To close: Slide the switch forwards.

Note:

When raised, the roof lining moves back only a few centimetres.

One-touch function*

Sunroof opens or closes automatically if the switch is moved once in the desired direction. Movement is stopped by touching the switch again. The one-touch function cannot close the roof from the raised position.

After the ignition has been switched off, the electric windows can still be operated

- in ignition key positions 1 and 0 or
- with the key removed and also
- if the doors are opened once only.

Protective function

If the sunroof panel, when operated by the one-touch function or from a door lock, encounters an obstruction after it has closed about halfway, it will come to a halt and re-open slightly.

After an **interruption to the power supply** (for example if the batteries are disconnected), the protective function must be re-activated by pressing the switch or sliding it forward and holding it in position until the sunroof panel is fully raised.

To avoid draughts or zones of low air pressure, the ventilation system outlets should be in use when the roof is open and in particular when it is raised; increase the airflow from the ventilation system if necessary.

If an electrical defect occurs, the sunroof can be operated manually. See Page 101.

An electronic automatic circuit breaker protects the system against overloads and malfunctions.

Convenient operation of the sunroof from the door lock

Opening: With the door closed, turn the key to the "deadlock" position and hold it there.

Closing: With the door closed, turn the key to the "Engage central locking system" or "Engage deadlock" position and hold it there.

Movement of the sunroof stops when the key is released.

For convenient closure/opening of the sunroof by means of the remote control, see Page 25.

Warning:

Careless or unsupervised closure of the sunroof could cause injury. Make quite sure that children cannot operate the switches accidentally, by taking the ignition key with you when you leave the car.

Note:

To prevent low air pressure or draughts inside the car when the sunroof is slid back, and in particular when it is tilted up, keep the ventilation system's air outlets open and boost the airflow through them if necessary.

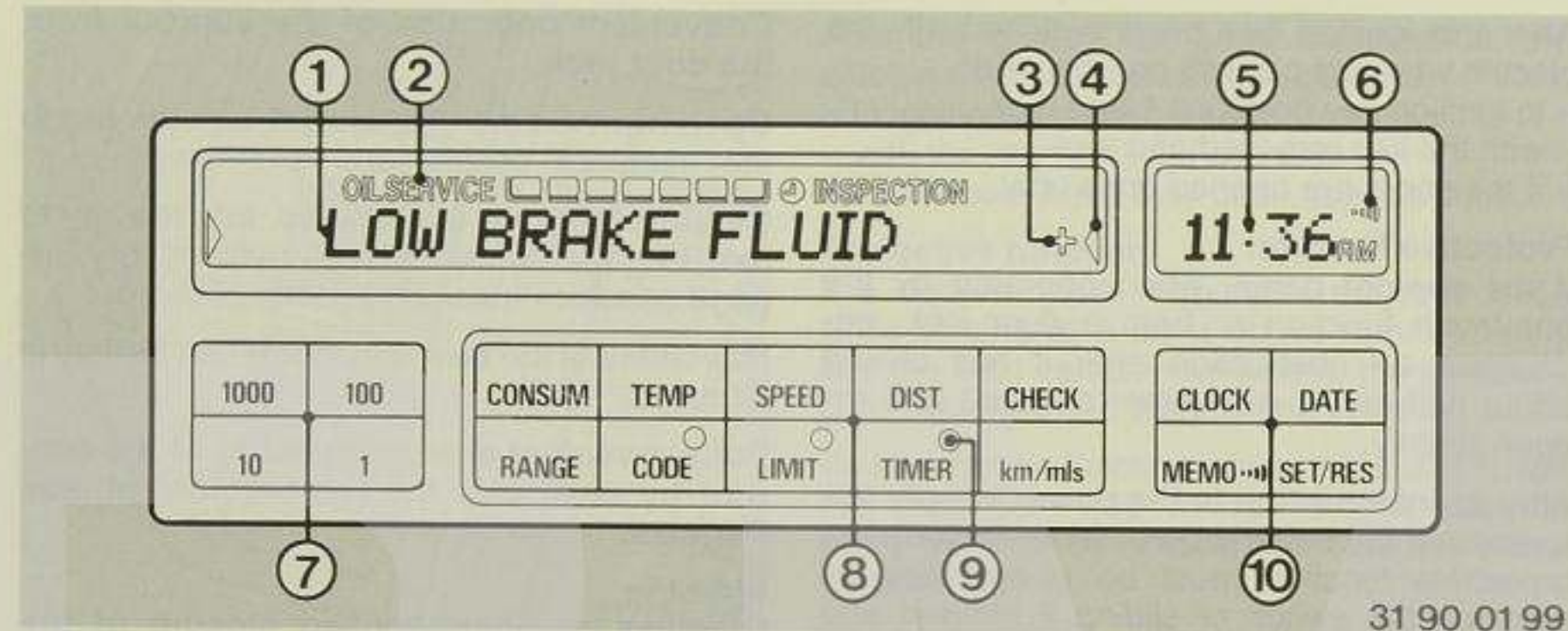

31 90 01 99

Multi-information Display (MID)

The MID contains:

- Service Interval indicator
- Digital clock with date display
- On-board computer for information and calculations which contribute towards safe, economical driving
- to operate the independent heater/ventilation control
- to activate the immobilizing device
- Check Control

Page	1 Display
43	2 Service Interval indicator
44	3 Plus sign indicates that further displays are present
46	4 Sign that a display is present
50	5 Digital clock
51	6 Sound-wave symbol for reminder function
53	7 Numerical input keys
	8 Information keys
	9 Light-emitting diodes (LED)
	10 Function keys

Explanations and operating instructions for the various functions and displays are given on the following pages.

Service Interval indicator

Green panels: As the time for your car's next maintenance routine approaches, the green panels gradually go out.

Yellow panel with OILSERVICE or INSPECTION: comes on when one of these routines is due.

Red panel: Maintenance work is overdue.

Clock symbol with INSPECTION: a brake fluid change is due.

Warning:

Periods of time in which the car's battery is disconnected are disregarded by the display's counter.

Take any such periods into account with regard to the specified brake fluid renewal intervals (two years), and do not wait until the brake fluid renewal reminder is displayed.

All displays go out after the engine has been started.

The BMW service station resets the Service Interval indicator to the original display after the maintenance work has been carried out.

For further details, please see Page 124 and refer to the car's Service Booklet.



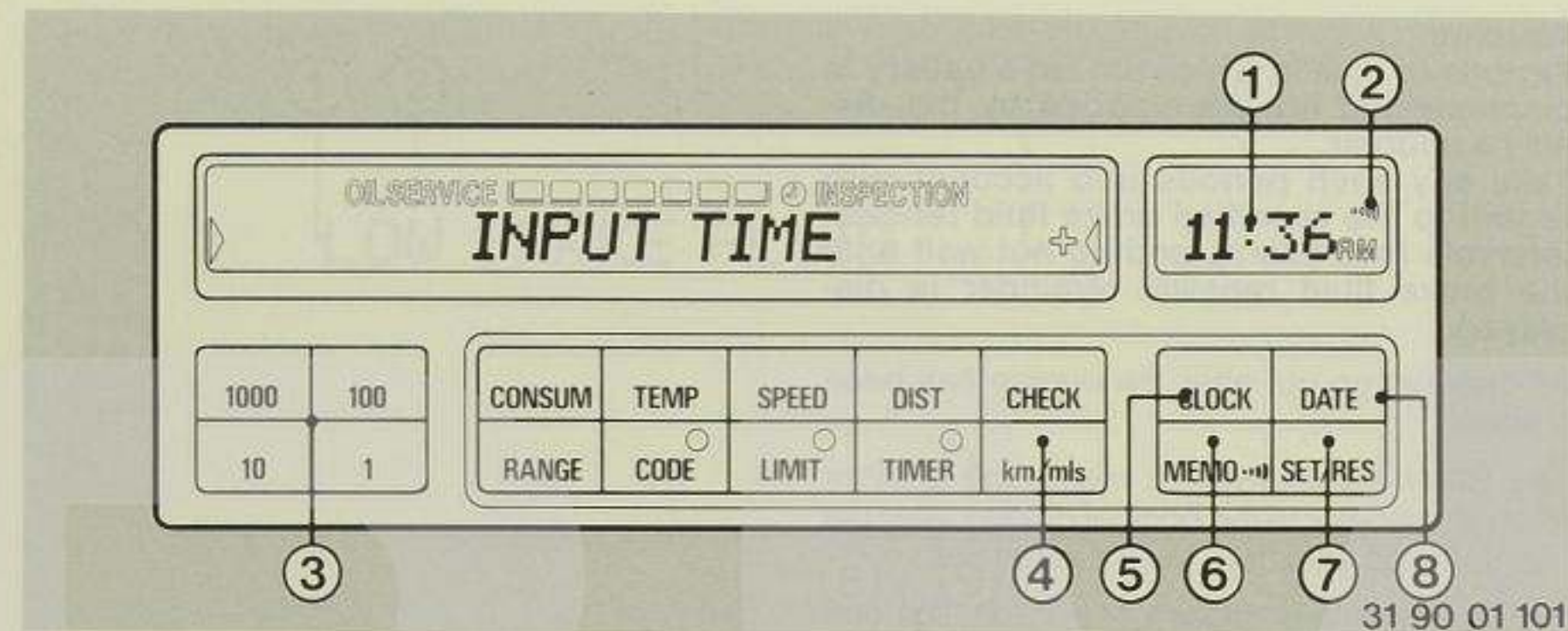

Digital clock

The digital clock can be used to
 – display time and date
 – program a reminder signal (Memo) every hour, for instance so that radio news bulletins are not missed.

- 1 Digital clock display
- 2 Sound-wave symbol for memo function
- 3 Numerical input keys
- 4 Display units changeover key
- 5 Clock function key
- 6 Memo function key
- 7 Start/Stop key
- 8 Date function key

Obtaining time and date display:

– Press the appropriate function key (5/8).

In ignition key position 0 or with the ignition key removed, the display appears for a few seconds only; in ignition key position 1 and beyond, the value remains on display.

You can have the time displayed as a 12- or 24-hour clock and the date in European or American order. Changeover:

– Press the function key (either TIME or DATE) and the display units changeover key (km/mls) at the same time.

When the 12-hour clock is in use, the letters AM or PM appear at the right of the display.

Memo function:

Press the MEMO key to switch this function on and off.

The signal is heard 15 seconds before every full hour. A sound-wave symbol appears in the clock display to indicate that the Memo function has been selected.

Important notes on the following inputs:

All time and date settings are made by way of the numerical input keys, according to the following principle:

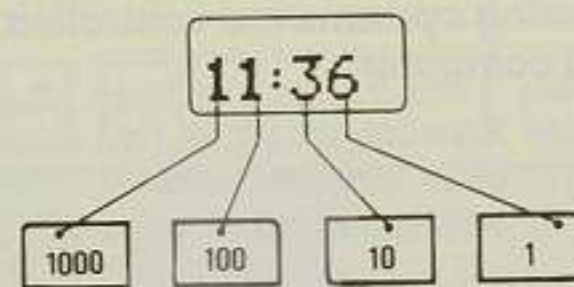

The digits can be input in any order. Each time a key is pressed, or if it is held down for half a second, the value increases by one.

Altering the time display:

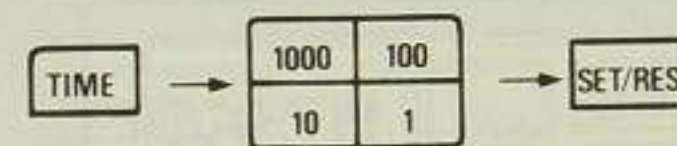

(Press the TIME key until the MID displays "INPUT TIME" and the time display flashes.)

Altering the date display:

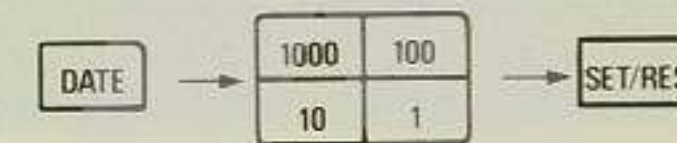

(Press the DATE key until the MID displays "INPUT DATE" and the date display flashes.) If necessary, input the year before pressing SET/RES, if the display calls for this input (INPUT YEAR). (The device takes leap years into account, so that no special manual adjustment is necessary.)

Time and date inputs after a power supply interruption:

The time display flashes and the MID displays "INPUT TIME".

- Input the correct time at the numerical input keys.
- Press SET/RES. The clock will start to run.

The MID displays "INPUT DATE".

- Input the correct date at the numerical input keys.
- Press the SET/RES key.



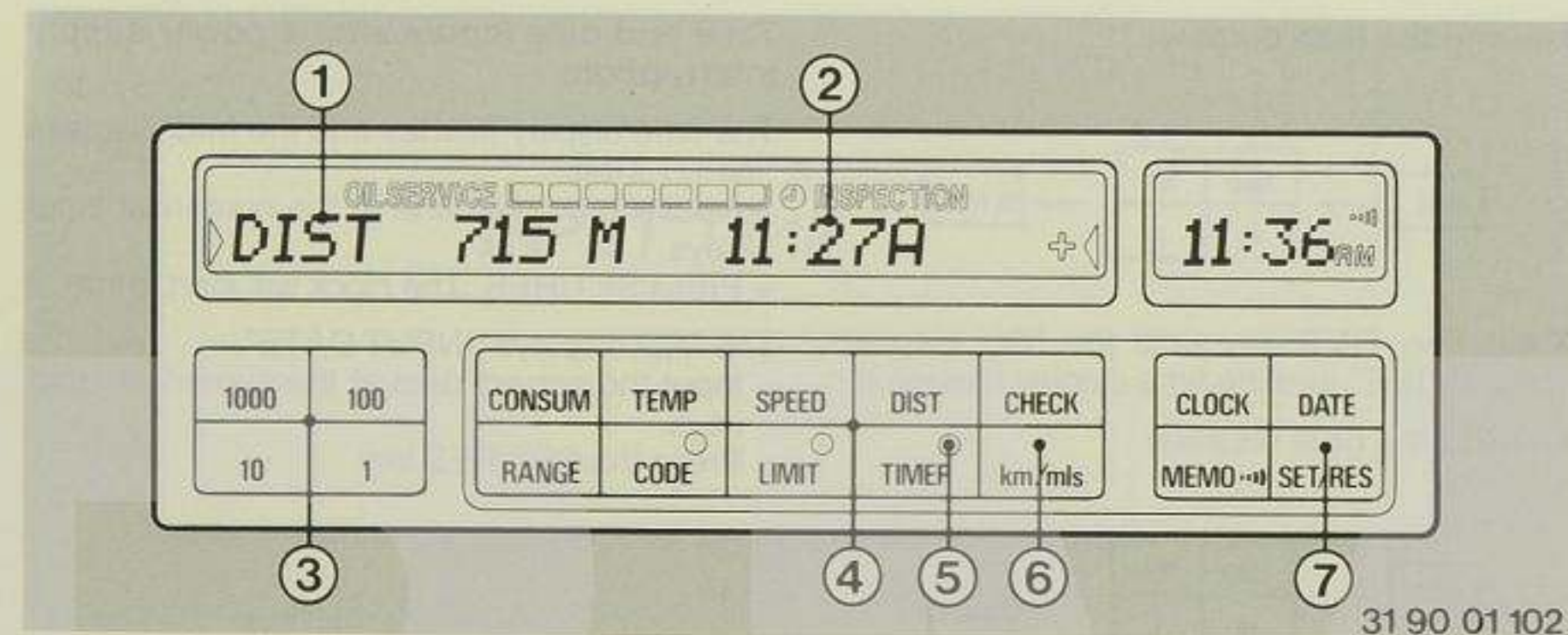

On-board computer

- 1 Display
- 2 Time of arrival
- 3 Numerical input keys
- 4 Information keys
- 5 Light emitting diodes (LED)
- 6 Display unit changeover key
- 7 SET/RES key (start/stop)

The on-board computer can be used to call up and display information which contributes towards safe, economical driving.

Available without previous inputs:	Page
TEMP Outside temperature	47
RANGE Probable range	47
SPEED Average speed	47
CONSUM 2 average fuel consumptions	48

After manual inputs:

DIST Distance before destination is reached, with time of arrival 48

LIMIT Speed limit 48

The following systems are controlled by the on-board computer:

- TIMER – 2 switch-on times for independent heater/ventilation control 50
- Direct operation of independent heater/ventilation control 50
- Stopwatch 49

CODE Immobilizing device 51

The on-board computer can be operated from ignition key position 1 onwards.

For road safety reasons, always input data to the computer before starting your journey or when the car is at a standstill. The computer calculates and memorizes data from the start of the journey onwards.

Information can also be displayed by operating a remote control; see Page 52.

The display units changeover key (6) enables information to be displayed either in metric or Imperial units of measurement.

Note:
Check Control warnings displace the computer displays.

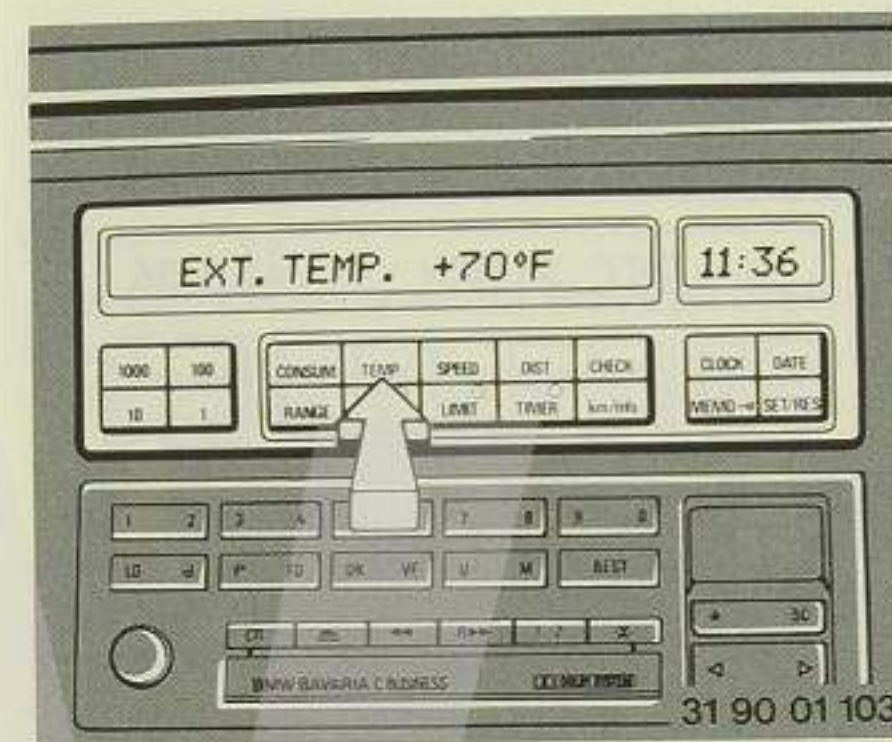

Outside temperature

To display: Press the TEMP button.

If the outside temperature falls below +3°C, a gong signal is heard as a warning; the outside temperature is displayed and flashes for 8 seconds.

The warning is repeated if the temperature rises to at least +6°C and then drops again to +3°C.

Important:
Whether or not a temperature warning is given, remember that ice can still form on the road at above +3°C in certain circumstances, for instance on bridges and in shadow.

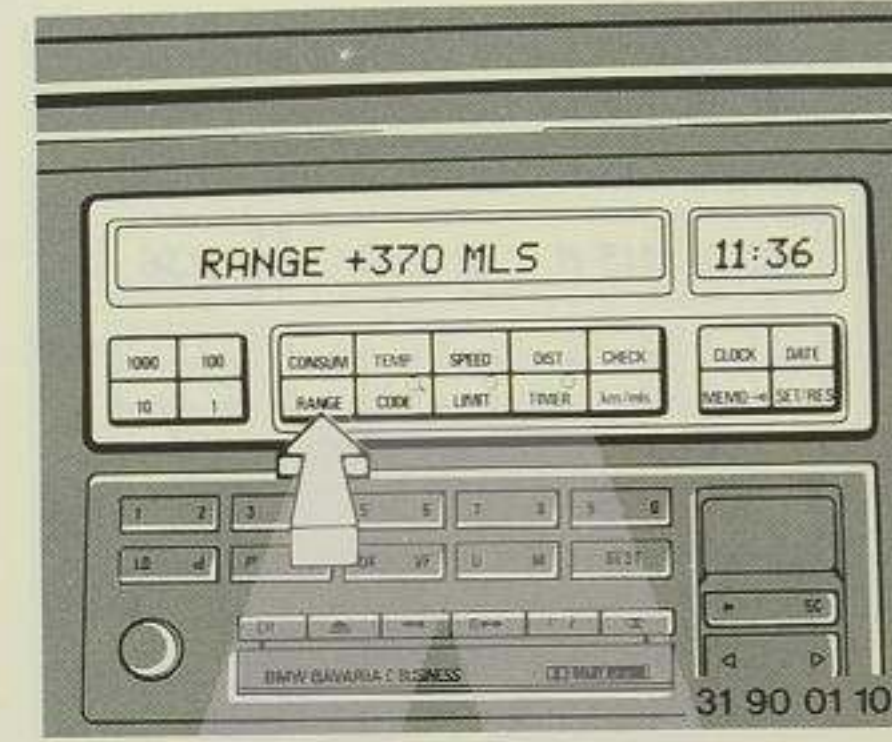

Probable range

This display indicates how far the car can probably be driven on the fuel remaining in the tank. The value takes into account the way in which the car has so far been driven.

To display: Press the RANGE button.

A plus sign (+) in front of the displayed value means that it is still undergoing a correction process (measuring tolerance).

If three display segments flash, the range is below 15 km and the car should be refuelled as soon as possible.

The on-board computer registers fuel added to the tank only
– if the quantity of fuel exceeds 4 litres and
– when the engine has been stopped.

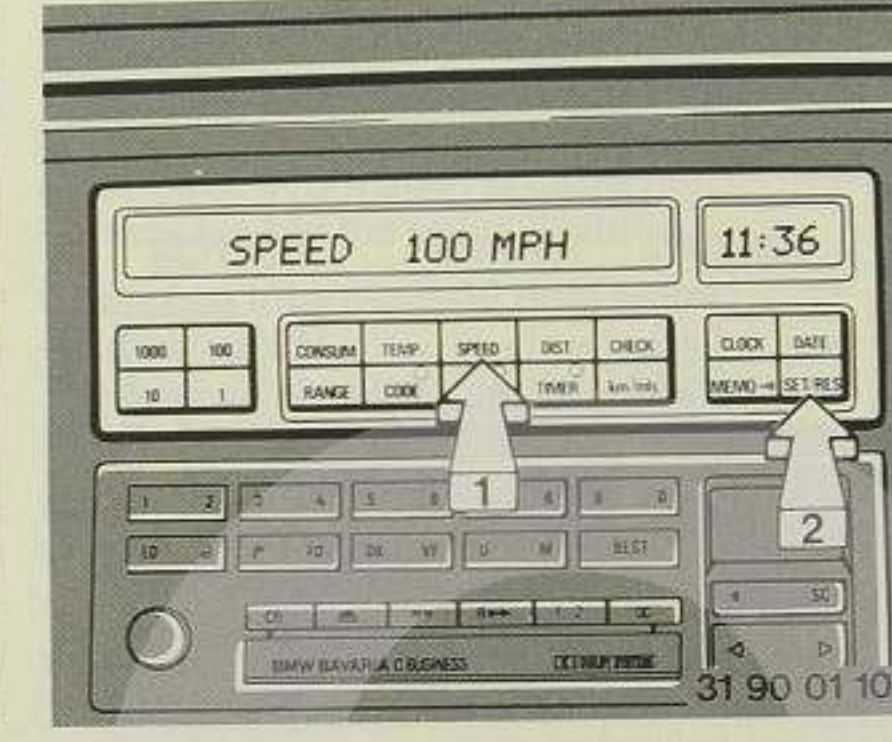

Average speed

To start computing:
Press the buttons in the order illustrated.

To display: Press the SPEED button.

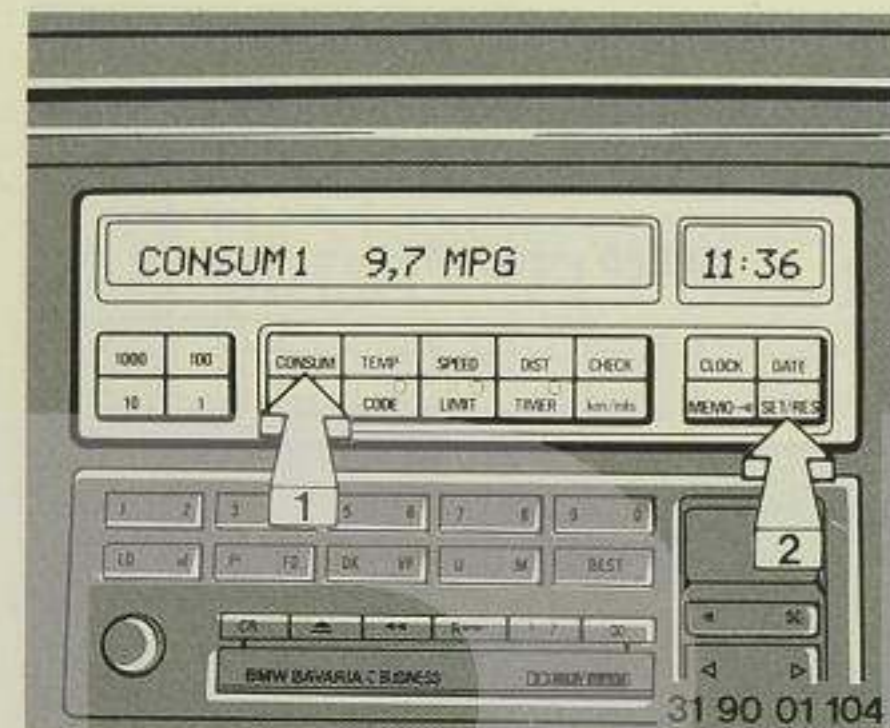

Average fuel consumption

Average fuel consumption can be computed for two distances in parallel, for instance a complete journey and one section of the journey.

To start computing for distance 1:
Press the buttons in the order illustrated.

To start computing for distance 2:
Press the buttons again in the order illustrated.

To display: Press the CONSUM button.

Each time this button is pressed, the display alternates between the average consumptions for distances 1 and 2. There is also an indication of whether distance 1 or 2 is being displayed.

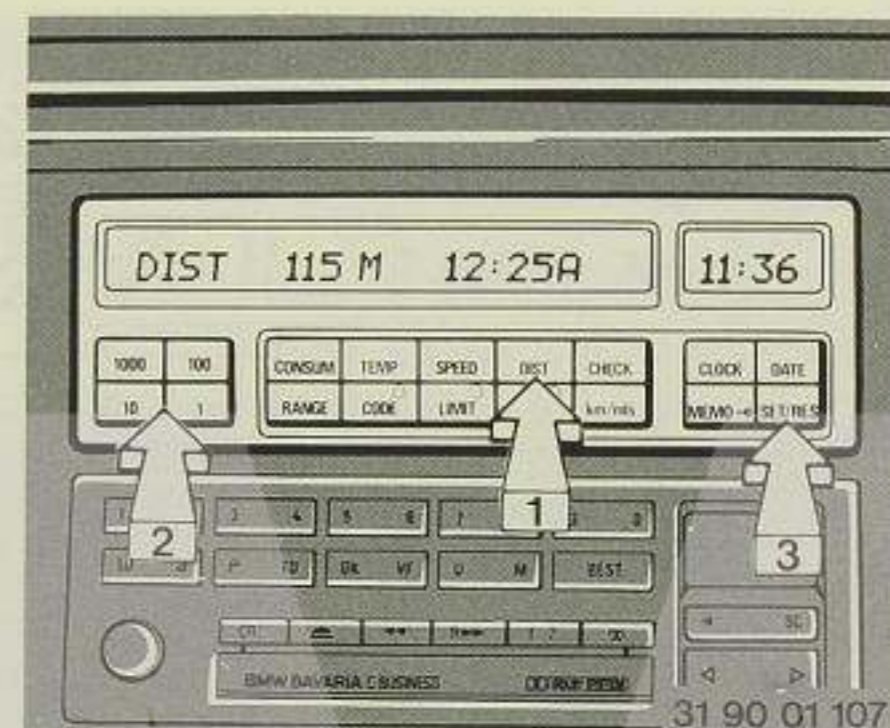

Distance from destination

Shows how far the car is from the destination, provided the total distance was input before the journey started.

Distance input:
Press the keys in the order illustrated.

To display: Press the DIST button.

The probable time of arrival, which is recalculated continually as driving conditions change, is also displayed.

If the car has already completed the full distance which was input at the start of the journey, the distance value is preceded by a minus sign.

Display units changeover:
Press km/mls changeover key once
– to alter the distance display
or twice
– to alter the arrival time display also

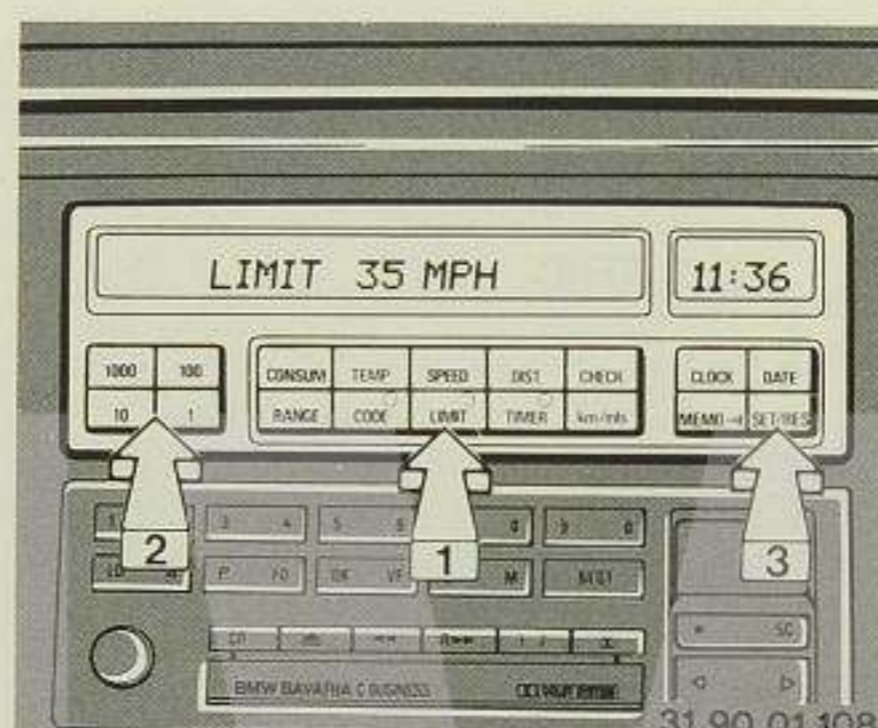

Speed limit

If you exceed a speed limit which you have previously input (for instance in order not to infringe legal road-speed limits), you will hear a warning gong. The corresponding LED flashes and the display shows the stored limit briefly.

The warning is repeated if the speed limit is again exceeded after the car's speed has in the meantime dropped by at least 5 km/h.

Speed limit input:
Press the keys in the order illustrated. The LED will come on.

Cancelling the speed limit input:

– Press the LIMIT button again.
The LED goes out, but the stored value is not lost and can be re-activated with the LIMIT button.

Adopting the car's actual speed as the limit value:

– Press the LIMIT and SET/RES buttons.

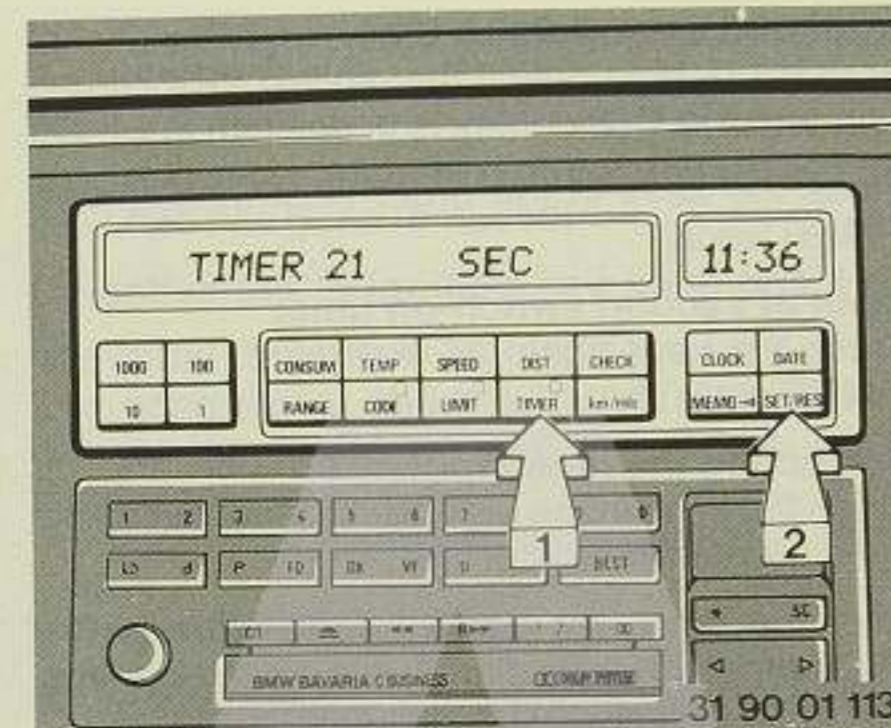

Stopwatch*

The stopwatch function is only available on cars without independent heater and ventilation control. It runs for 99 hours, 59 minutes. The time appears in the display: at first in seconds and tenths of a second, after one minute in minutes and seconds, and after one hour in hours and minutes.

Start:
Press the keys as illustrated.
The LED comes on and the cumulative time is shown in the display.

Stop:
With the time displayed
– Press SET/RES.

If any other information is displayed:
– Press keys in the order illustrated.

Obtaining intermediate time value:

– Press TIMER.
The LED flashes and the intermediate time is displayed. The stopwatch continues to run.

Obtaining main stopwatch time display again:

– Press TIMER again.

Note:
The stopwatch ceases to run in ignition key position 0, but runs again in ignition key position 1.



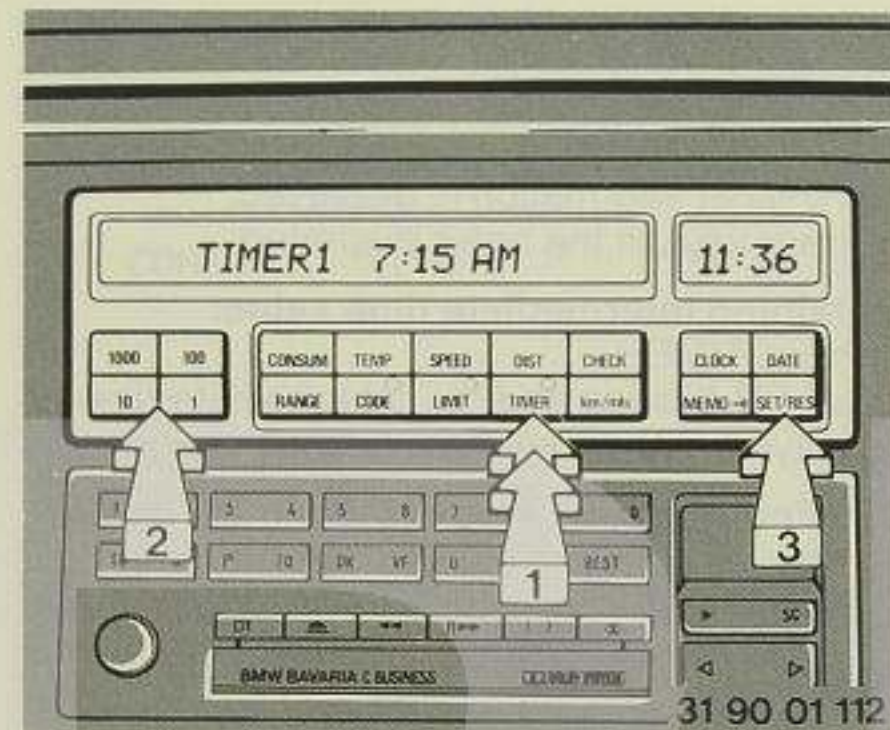

Independent heater* / independent ventilation control*

Input of switching times

You can preselect two switch-on times for the independent heater or ventilation control. Switching on depends on outside temperature: the heater can be operated below 16°C, the ventilation above 16°C. The heater or ventilation is switched off automatically after 30 minutes.

For important information on operating the independent heater/ventilation control, see Page 70.

When the TIMER button is pressed, the display shows the current operating condition of the independent heater/ventilation control.

Input of first switch-on time:

Input is possible only if the digital clock is running and the ignition key is in position 1.

Press the keys in the order illustrated (press TIMER twice).

Input of second switch-on time:

Press the keys again as illustrated, but press TIMER once only.

Correcting the time input:

Press the keys in the order illustrated, including the different time input.

After the input, the display shows * and the LED comes on as a sign that a switch-on time has been preselected.

The LED flashes while the heating or ventilation is actually in operation, and goes out when they are switched off.

To check a previous switch-on time input:

- Press TIMER twice for the first time input.
- Press TIMER three times for the second time input.

The switch-on time inputs can be activated as follows (heating or ventilation starts (LED comes on) and stops (LED goes out) at the specified times:

Press SET/RES after selecting the desired switch-on time.

The switch-on times remain stored until cancelled by a new input.



Direct switch-on

This is only possible in ignition key position 1.

Press the keys in the order illustrated.

Direct switch-off

In ignition key position 1, press the keys in the order illustrated.

In ignition key position 0 or 1, press SET/RES only.

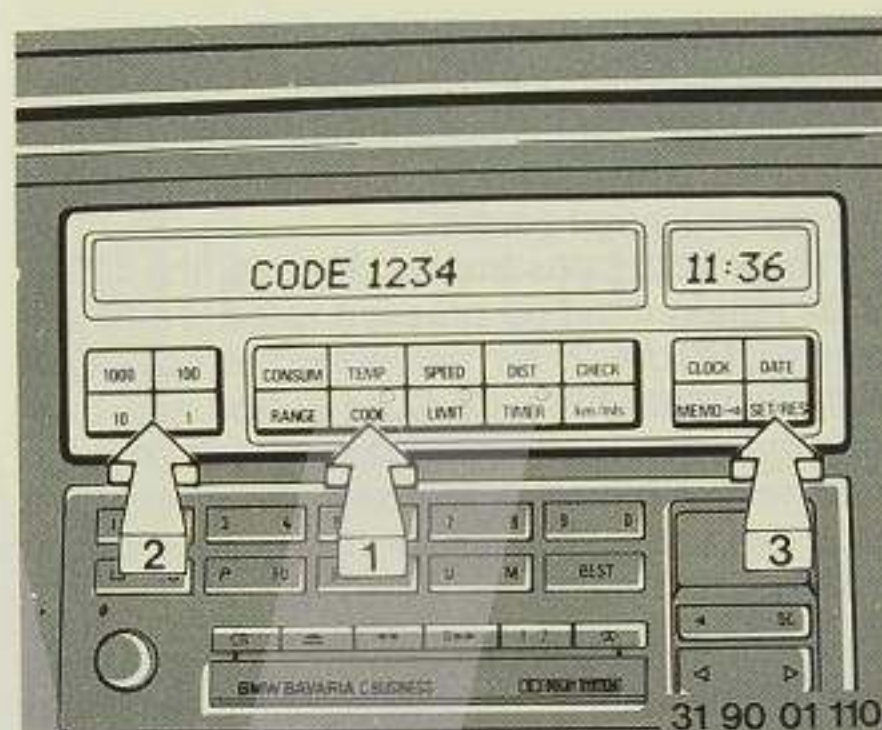

Immobilizing device

The engine compartment lid, radio and any attempts to start the engine are monitored. The device is activated with a code number. Starting the engine, removing the radio or opening the engine compartment are then impossible unless the code number is input correctly. For this reason: **always remember the code number!**

Activating in ignition key position 1:

Press keys in the order illustrated, then turn ignition key to position 0 and remove.

Any code number from 0000 to 9999 can be input. (The same or a different code number must be input each time the device is activated.)

In ignition key position 0 or with the key removed, the LED will remain on for up to 36 hours. If the LED flashes for about 10 seconds, the engine compartment is not properly closed (or the radio has been removed).

De-activating in ignition key positions 1 or 2:

- The gong signal and the "---- CODE" display call for the driver to input the chosen code number.
- Input the code number at the numerical input keys.
- Press the SET/RES key.

If attempts are made to start the engine without a code input, the gong will sound and the engine will not start.

The alarm will sound for 30 seconds after three incorrect code inputs or three attempts to start the engine without a code input.

If the code number has been forgotten, proceed as follows:

- Disconnect the battery, then reconnect it.
- Turn the ignition key to position 1.
- The alarm will sound and a time display will appear and run down for 15 minutes.
- After 15 minutes, the engine can be started.

If the code number becomes available again during this 15-minute waiting period, it can be input at the keys in the order illustrated.



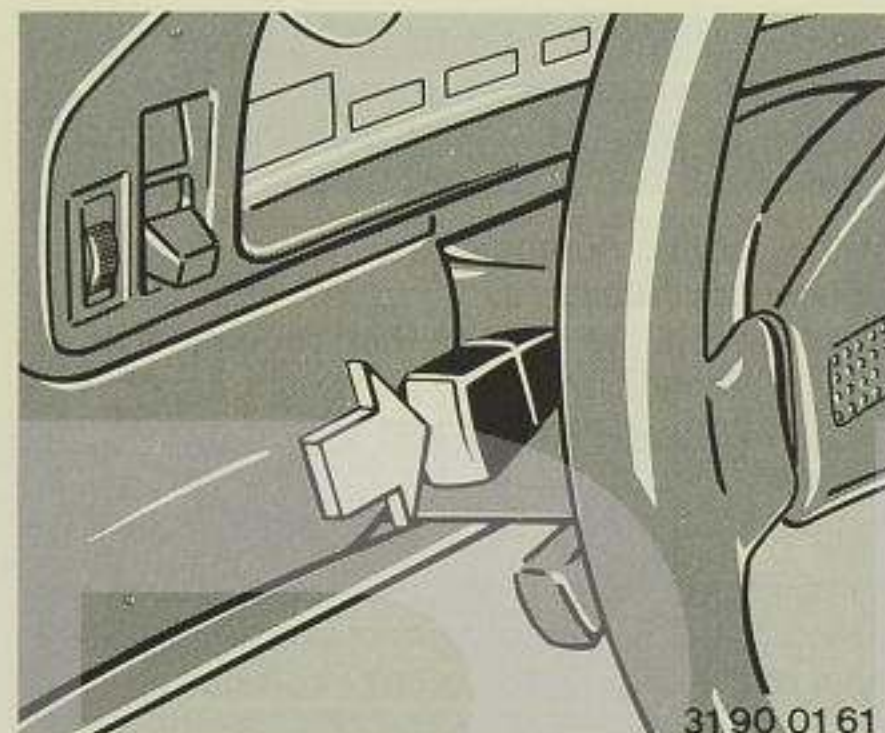

31 90 01 61

Remote control

The flashing turn indicator lever can also be used to display on-board computer information.

You must first program the items of information you wish to display in this way.

Input:

- Press the turn indicator lever in until the display shows "PROG 1".
- Press the computer information buttons for the displays you need. The program number appears in the display for each input.
- Press the SET/RES button.

If you wish all the information to be accessible by operating the remote control:

- Press the turn indicator lever until "PROG 1" appears.
- Press SET/RES.

Note:

The following should be noted in connection with average fuel consumptions 1 and 2 and switch-on times 1 and 2 for the independent heater/ventilation control:

To show both consumption figures, the CONSUM button must be pressed twice. To obtain only CONSUM 2, for example, but not CONSUM 1, press the CONSUM button and then the km/mis changeover button. (Each time the changeover button is pressed, the display will alternate between average fuel consumptions 1 and 2.)

Adopt the same procedure for independent heater/ventilation control switch-on times 1 and 2 if required.

To display:

Press the turn indicator lever in briefly.

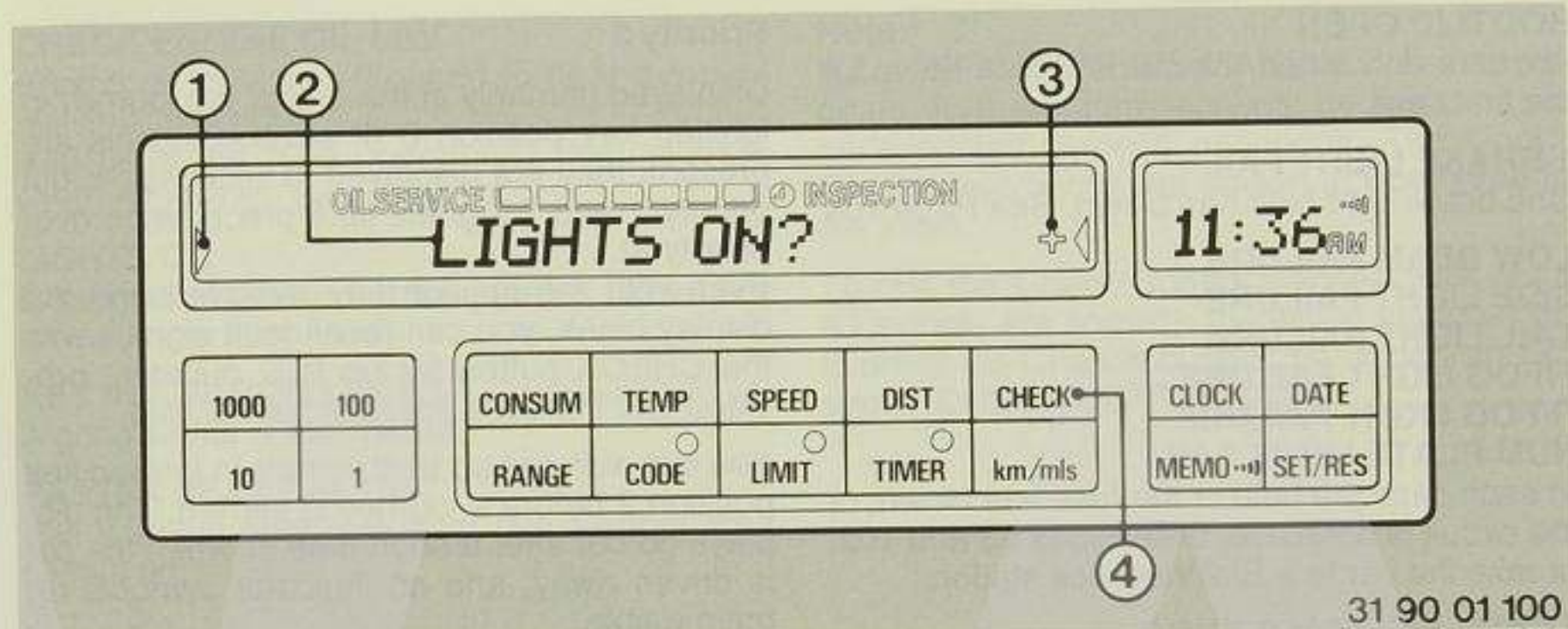

31 90 01 100

Check Control

System malfunctions are shown in plain text and a gong warning sounded. There is also a general warning light on the instrument panel which comes on during the journey if a fault signal is present.

- 1 Fault display indicator
- 2 Display
- 3 Plus sign for further fault displays
- 4 CHECK button

A system of 3 priority categories has been adopted for the fault signals:

Priority 1

These faults are shown immediately with a gong signal and flashing indicators in the display (1). If several faults of equal priority develop at once, they are displayed in succession. These displays remain active until the fault is rectified and cannot be cleared with the CHECK button (4).

HANDBRAKE ON

This signal appears shortly after the car has begun to move.

BRAKE ASSIST INACT.

The driver may have to exert extra effort when steering and braking, since the brake servo pressure is lost and the power assistance for the steering is also out of action. See Page 90.

BRAKE LIGHT CIRCUIT

The brake lights are not working. The fuse has blown or the circuit is interrupted. See Page 93, or consult a BMW service station.

BRAKE LIGHTS FAILURE

The brake lights themselves have failed - bulbs blown. Renew the bulbs. See Page 104.

LOW BRAKE FLUID

Brake fluid level is close to the minimum mark. Top up at the earliest opportunity. See Page 87. Have the cause of brake fluid loss rectified by a BMW service station.

ENGINE OIL PRESS LOW

Engine oil pressure has dropped too low. Stop the car immediately and switch off the engine. See Page 10.

COOLANT TEMPERATURE

The temperature is too high. Stop the car immediately and switch off the engine. See Pages 13 and 88.

**CHECK LEFT BACKREST
CHECK RIGHT BACKREST**

The driver's or front passenger's seat backrest is not locked into position. Press the seat back rearwards and down, making sure that its movement is not obstructed, until it locks into position.

Warning:
The seat belt cannot provide full protection unless the seat back is correctly locked into position.

CATALYST OVERHEAT*

Stop the car and allow it to cool down until the display goes out.

If necessary, consult a BMW service station.

SPEED LIMIT*

Displayed if the car is driven faster than the maximum national speed limit. However, you must also comply with all regulations calling for a lower speed limit.

Priority 2

These malfunctions are displayed in ignition key position 2 (but priority 1 signals are automatically superimposed). After they have gone out, the indicator symbols remain visible. If the **plus sign** (3) appears, further signals are present, and can be displayed by pressing the CHECK button.

CHECK BACKREST LOCK

The seat back lock sensor is defective. Consult a BMW service station.

CHECK P.A.S. FLUID*

Level in fluid reservoir too low. See Page 86.

R/AXLE FAILSAFE PROG*

The Active Rear Axle Kinematics (AHK) have cut out as a result of a fault. The car can still be driven. If the steering wheel is slightly off-centre when driving in a straight line, the car will veer slightly from its chosen line of travel. See Page 115.

BOOTLID OPEN

Appears only when the car is driven away for the first time.

1 BRAKE LIGHT FAIL

One brake light bulb has blown. See Page 104

LOW BEAM FAILURE**SIDE LIGHT FAILURE****TAIL LIGHT FAILURE****F/FOG LIGHT FAILURE****R/FOG LIGHT FAILURE****NUM PLATE LIGHT FAIL**

In each case the bulb or the fuse has blown, or the circuit is defective. See Pages 93 and 102, or take the car to a BMW service station.

TRANS FAIL-SAFE PROG

Defective electronic control unit on automatic transmission cars. See Page 59.

BRAKE LININGS

The brake pads are worn. See Page 90.

WASHER FLUID LOW

Top up at the next opportunity. See Page 89.

Priority 3

Displayed primarily at the end of the journey in ignition key position 0 (if several signals are present, they are displayed in succession, but priority 1 and 2 signals take precedence over priority 3).

Even with the ignition key removed and the display blank, you can recall fault signals with the CHECK button for up to 2 minutes, provided that the car's doors remain closed.

You can also call up fault signals in ignition key position 2 before a journey is started. The displays go out after a short time or when the car is driven away, and no indicator symbols remain visible.

The signals are repeated only in ignition key position 0.

If a plus sign is visible: call up further fault signals by pressing the CHECK button.

CHECK ENGINE OIL LEV

Engine oil level has dropped to near the permissible minimum.

Add oil at the next opportunity (for instance when refuelling). See Page 83.

LIGHTS ON

Displayed at the end of the journey (when the driver's door is opened).

KEY IN IGNITION LOCK*

A gong signal is also heard.

FASTEN SEAT BELTS*

The warning light with seat belt symbol also comes on.

Note:

If the "SEE OWNER'S MANUAL" display appears, further information will be found in the car's printed owner's handbook. The Check Control references are shown in **bold type** in the index.

To test the Check Control display (only when no signals are shown): In ignition key position 2, press the CHECK button: the display should show "CHECK CONTROL O.K."

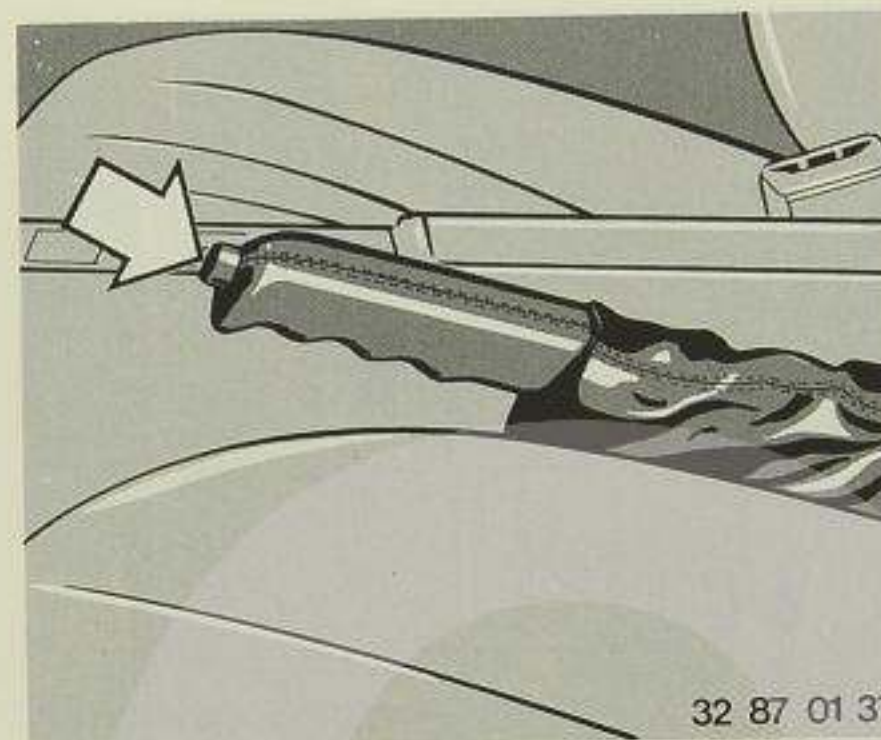

32 87 01 37

Handbrake**Applying:**

The lever has a ratchet which holds it on automatically. The "P" telltale light on the instrument panel comes on.

Releasing:

Pull the lever up slightly, press the knob on the end and lower the lever.

The handbrake acts on the rear wheels. If it has to be applied while the car is moving, do not pull the lever up too hard, or else the rear wheels could be overbraked and the tail of the car could slide.

Important:

The brake lights do not come on when the handbrake is applied.





31 93 01 135

BMW 850Ci

Programmable electronic power control (EML)*

The electronic power control which takes the place of a conventional accelerator linkage has two programs: sport and comfort (S and K).

Switch positions:

K = Comfort setting, for driving at moderate engine power or on a wet or slippery road

S = Sport setting

The switch is illuminated in ignition key position 2. Only the S setting is shown on the instrument panel.

If the EML warning light on the instrument panel indicates a malfunction, take the car to a BMW service station.

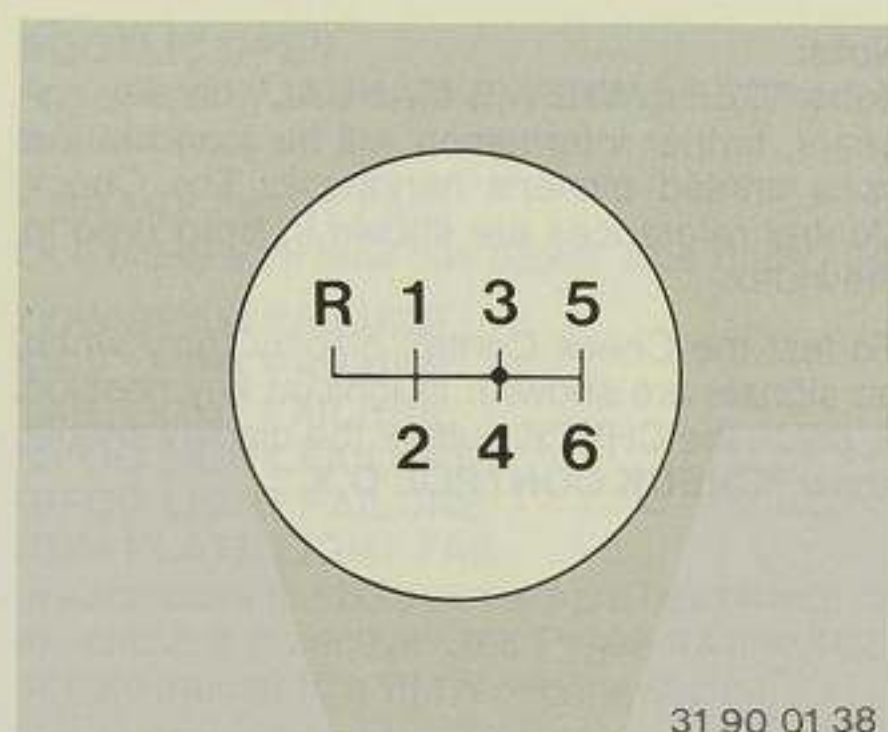

31 90 01 38

Manual gearbox

The normal rest position for the gear lever (marked by a dot) in the 3rd/4th gear plane of the gate.

When neutral is selected from any gear, the lever moves back to this position.

There is synchromesh on all gears.

Important:

Due to the functional features of the triple synchromesh, 6-speed gearboxes have higher shifting forces from 1st to 2nd gear.

When selecting 5th or 6th gear, the lever must be pressed firmly to the right, to ensure that 3rd or 4th gear is not selected accidentally.

At an engine speed higher than 5000/min in 6th gear, never shift down to 5th, or the engine will overspeed and could be damaged.

Reverse

Engage this gear only when the car is standing still. Press the gear lever to the left until slight resistance is overcome.

Reversing lights

These come on in ignition key position 2, when reverse gear is selected.

Warning:

Never hold the car on an uphill gradient by slipping the clutch. Always apply the handbrake. A clutch that is allowed to slip will wear rapidly.

Warning:

Please do not drive the car if you are under the influence of alcohol. Even small amounts of alcohol or drugs can adversely affect your perception, your judgement, your powers of decision and your reflexes, particularly if taken at the same time as medicines. The risk of severe or even fatal accidents, possibly involving innocent parties, is very much higher in such circumstances. Do not allow any other persons, even those well known to you, to drive the car if you are aware that they have consumed alcohol or taken drugs.

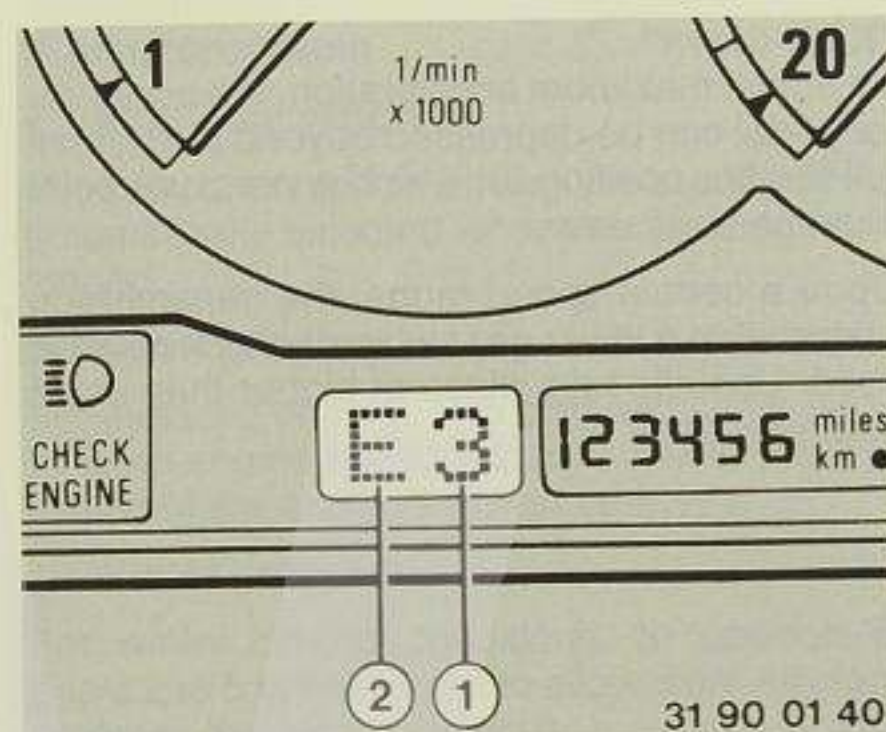

31 90 01 40

Automatic transmission

Selector lever positions (1):

BMW 840Ci P R N D 4 3 2

BMW 850Ci P R N D 3 2 1

There are also three or - with AGS - two driving programs (2), which are selected at a separate program switch:

BMW 840Ci

- E (Economy) } Press the switch
- S (Sport) } Slide the switch
- * (Winter) } in the desired direction.

BMW 850Ci

- E (Economy) } Press the switch
- S (Sport) } Slide the switch
- M (Manual) } in the desired direction.

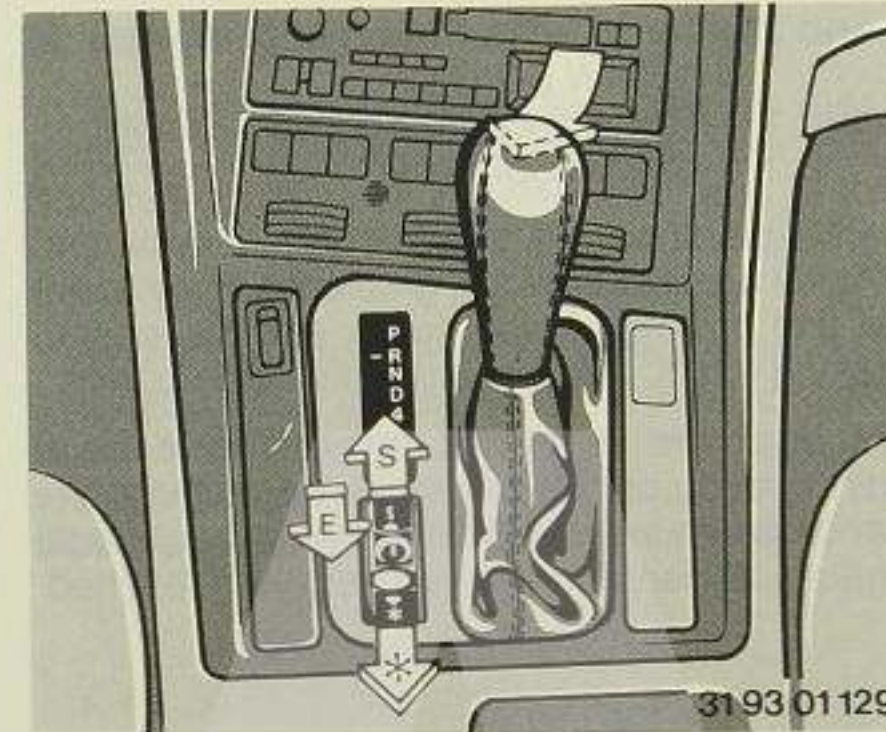

31 93 01 129

BMW 840Ci

For details of the programs, see Page 59 or, for AGS, Page 60.

There is a locking catch on the front of the selector lever handle, which prevents the lever from being moved accidentally to various positions. Press it in to release.



31 90 01 41

BMW 840Ci

Note:
The engine can only be started in the P or N position.

If the engine is running, even if you do not touch the accelerator, the car will move when a gear is selected.

After moving the lever, wait for the selected gear to engage before depressing the accelerator.

Do not leave the car with the engine running unless you have moved the selector to P or N and applied the handbrake.

If you select N accidentally at a fairly high engine speed, release the accelerator immediately. Wait for the engine speed to drop before selecting the desired gear.



P – Park

Select only when the car is standing still. The driven wheels are locked.

R – Reverse

Select only when the car is standing still.

N – Neutral

Select only if the journey is interrupted for a fairly long time. When the car is being driven at speed, only select neutral if a skid develops.

D – Drive (all gears of automatic transmission available)

Use this position for all normal driving. The transmission itself will select whichever of the four forward gears is most suitable.

4 – Direct (BMW 840Ci)**3 – Direct (BMW 850Ci)**

The transmission only shifts up as far as 3rd or 4th gear. Select this position if in position D you feel a frequent change between the 5th and 4th gears (BMW 840Ci) or between the 3rd and 4th gears (BMW 850Ci).

The 5th or 4th gear is not engaged.

3 and 2* – for hill-climbing and braking (BMW 840Ci)**2 and 1 – for hill-climbing and braking (BMW 850Ci)**

Select these positions on mountain roads and lengthy uphill or downhill gradients. They make full use of both engine power and the engine braking effect, and avoid undesirable upshifts.

The lever can be moved to these positions at any speed, but to avoid overspeeding the transmission will not shift down in each case until a sufficiently low speed has been reached.

"Kick-down"

To obtain maximum acceleration, the accelerator pedal can be depressed beyond the normal full-throttle position, at which a pressure point must be overcome.

Up to a certain speed range, the transmission may shift to a lower gear when the kick-down is used. Upshifts take place at higher than usual engine speeds.

Driving programs**E – Economy program**

For low-consumption driving. This program is automatically selected whenever the engine is started.

S – Sport program

For dynamic driving. This program shifts up at a higher engine speed, so that full advantage is taken of the engine's power reserves.

*** – Winter program**

For wintry driving conditions. In position D gears 2 to 5 are selected to allow more efficient progress in wintry conditions.

The gear selected is maintained in positions 4, 3 and 2. This means that the car also starts off in this gear and does not shift down when accelerating hard.

It is a good idea, e.g. on inclines or when towing a trailer, to drive in selector lever position 2; or in position 4 in winter for this makes it possible to start off smoothly on slippery roads and avoids unwelcome shifting.

M – Manual program

In this program the selected gear is maintained. The car starts off in this gear and does not shift down when accelerating hard. In this program you drive only in 3rd gear in position D.

It is a good idea, e.g. on inclines or when towing a trailer, to drive in either selector lever position 1 or 2; or in position 3 in winter, for this makes it possible to start off smoothly on slippery roads and avoids unwanted shifts.

"TRANS FAIL-SAFE PROG" signal on MID display:

An electronic control unit or an automatic transmission malfunction is indicated.

All selector lever positions are available, but in the forward travel positions the car remains in 4th or 5th gear.

BMW 850Ci:

To make better use of available engine power, 3rd gear can be obtained by stopping the car and switching off and restarting the engine.

In this situation, avoid severe loads and take the car to the nearest BMW service station without delay.

Note:

If this display appears and the transmission fails, do not attempt to drive the car any further; it must be repaired by a BMW service station.

Warning:

Never work inside the engine compartment if an automatic transmission gear has been selected. Never leave children unattended in the car.

For tow-starting, towing away and starting with a flat battery, see Pages 94 and 95.



* The 1st gear is selected automatically. Thanks to appropriate adaptation, this position is particularly suitable for trailer towing.

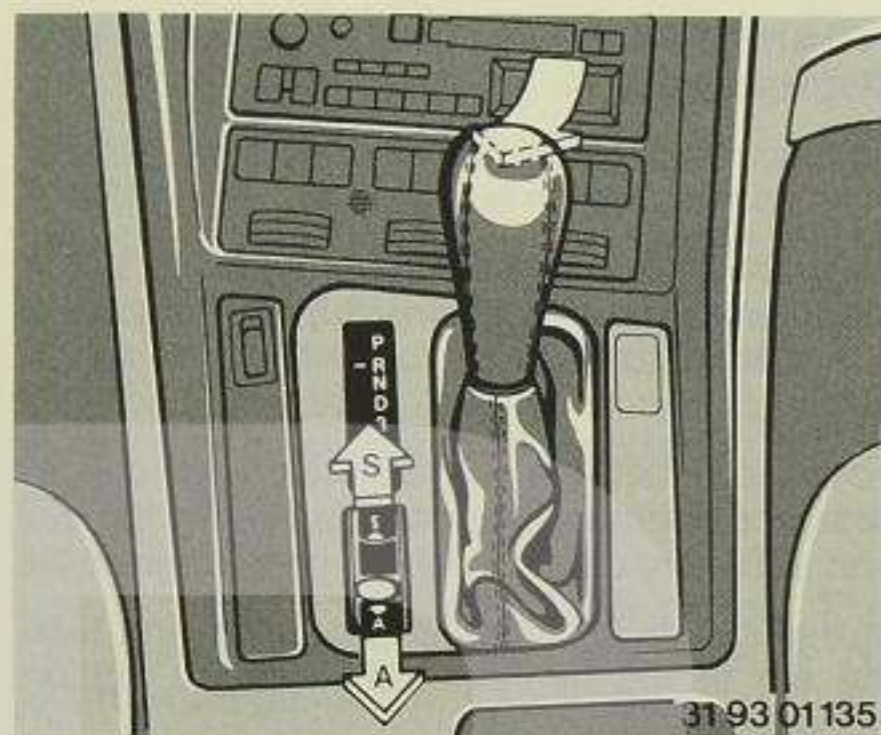

Automatic transmission with Adaptive Transmission Control (AGS)* - BMW 850Ci

Two programs can be selected at the program switch:

- A (Adaptive)
- S (Sport),

Slide the switch in the desired direction.

The selected program is displayed in the instrument cluster.

A – Adaptive program

This program is automatically selected whenever the engine is started.

In all forward-travel positions, Adaptive Transmission Control chooses the most suitable shift program from the various alternatives provided. It adapts continuously to the manner in which the car is being driven (e.g. calm and relaxed or harder and more dynamically), to road influences (smooth surfaces, severe uphill gradients etc.) and to actual driving circumstances (e.g. twisty roads, descending steep gradients).

S – Sport program

In this setting only the most dynamic of the available shift programs is used. Selection of this program is recommended as a means of making maximum use of the car's performance, regardless of the driving style at any given moment.

Selector lever positions

Selector lever positions are described on Page 58. Positions 3, 2 and 1 have the effect of limiting further upward shifts if this is desired by the driver.

3 – Direct: it is implied here that frequent shifts take place between 4th and 3rd gears in position D. This does not apply with AGS.

AGS also operates in selector lever positions 3, 2 and 1, though of course only gears up to the chosen lever position can then be selected.

Special functions

In Program A, Adaptive Transmission Control influences the choice of gear (speed range) in the automatic transmission by means of various special functions.

This has the effect of suppressing certain shifts that would normally have occurred, and may cause others to take place in special circumstances although the driver would not have expected them.

Suppressing upward shifts

If the accelerator pedal is released suddenly, when cornering hard or on steep downhill gradients, upward shifts are normally prevented. This ensures that engine brake effect is utilized and eliminates many unnecessary shifts when the car is driven in a markedly enthusiastic manner.

Performing downward shifts

The "kick-down" description on Page 58 also applies to AGS. However, in many cases even depressing the accelerator pedal sharply will initiate a downshift, so that the full kick-down movement does not have to be performed.

If the car is braked on a steep downhill gradient, the transmission shifts down by one gear provided that a given upper engine-speed limit is not exceeded. This increases the engine braking effect.

Suppressing downward shifts

When cornering fast, with high levels of lateral acceleration, a sudden downshift could cause a critical situation to develop. Such downshifts are therefore avoided by the AGS whenever possible.

Control of winter program

When driving on slippery surfaces (snow and ice), a winter shift program is selected automatically. The car moves away from a standstill in 2nd gear and shifts up to higher gears as early as practicable. This makes progress over slippery surfaces easier and enhances the car's traction and dynamic stability.

AGS switches out of the winter program as soon as a higher-grip road surface is identified, the sport program selected or the ASC+T switched off.





Automatic cruise control*

Any desired road speed above approx. 40 km/h can be memorized and maintained automatically.

The memorized speed value is lost when the engine is switched off.

1 ACCELERATION

Moving the lever briefly:

The car's actual speed is maintained and memorized. Each time the lever is moved briefly to this position again, road speed is increased by app. 1 km/h.

Holding the lever in this position:

The car accelerates without the accelerator pedal being touched. When the lever is released, the speed then reached is maintained and memorized.

2 DECELERATION

Moving the lever briefly:

The car's actual speed is maintained and memorized. Each time the lever is moved briefly to this position again, road speed is reduced by app. 1 km/h.

Holding the lever in this position:

The car decelerates without the accelerator pedal being touched. When the lever is released, the speed then reached is maintained and memorized.

3 RESUME

Moving the lever briefly:

The speed last memorized is recalled and maintained once it has been reached again.

4 OFF

Moving the lever briefly:

The cruise control facility is switched off, regardless of the actual road or traffic situation.

The cruise control is also switched off automatically:

- If the car exceeds the selected speed by app. 16 km/h.
- If the car's road speed falls more than 8 km/h below the selected speed.
- If a high rate of deceleration occurs (above 1.5 m/s²), for example on a steep hill, when braking and declutching or if the automatic transmission selector lever is moved from D to N.

Warning:

Do not use the cruise control on twisting roads, if traffic is heavy or in any other situation which makes it too difficult to maintain a constant speed, nor when the road could be slippery (snow, rain or ice) or on a loose surface (stone chippings or sand).

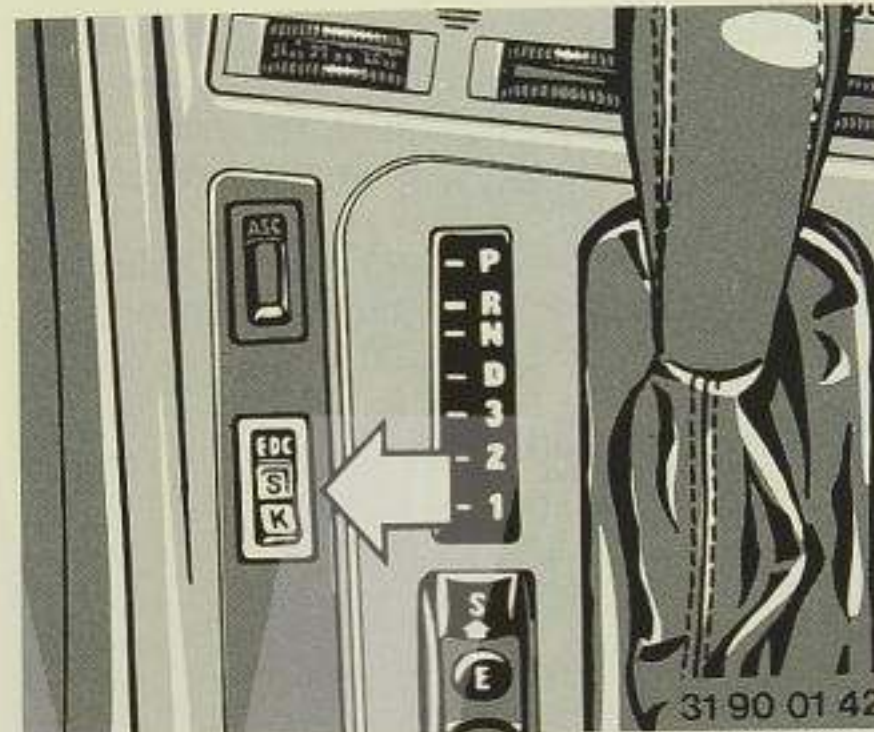

Electronic Damping Control (EDC)*

This system automatically ensures that the desired degree of suspension damping is provided, and thus enhances both safety and ride comfort.

Switch positions:

- K – Comfort program
- S – Sport program.

The driver can switch from one program to the other at any time.

In ignition key position 2, the selected switch position is illuminated.

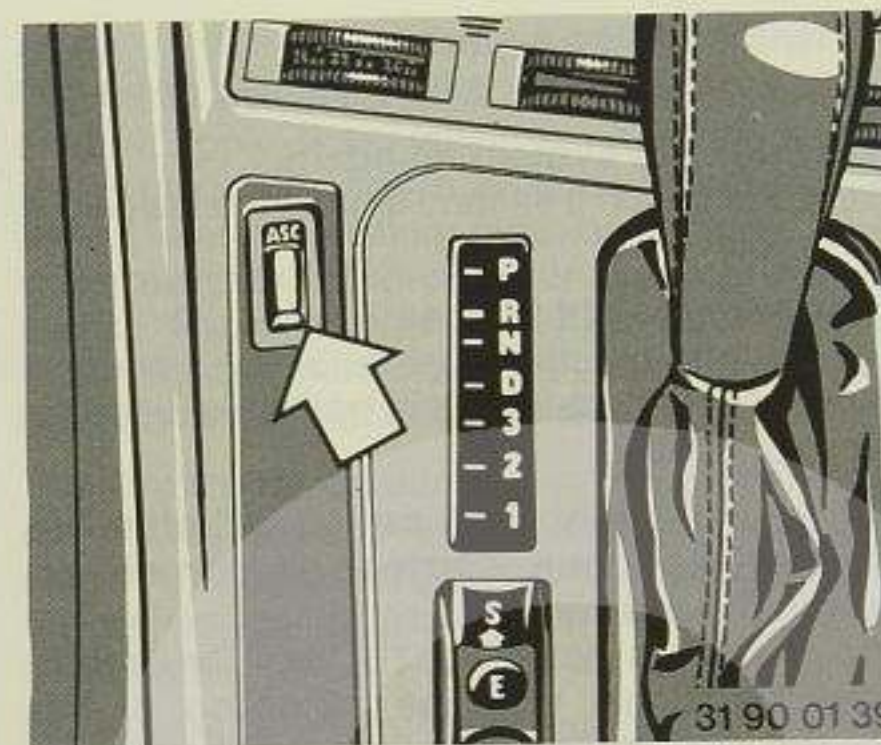

Automatic Stability Control plus Traction (ASC+T)*

This system improves driving stability, particularly when accelerating and cornering. It prevents the driven wheels from spinning when driving conditions are unfavourable (smooth or slippery road surface), and ensures that the maximum possible amount of power can always be transmitted through the tyres to the road.

The system is ready to operate whenever the engine is started.

The telltale light in the instrument cluster goes out after the engine has been started.

To switch off the system:

Press the button; the telltale light will come on.

To switch the system on again:

Press the button a second time; the telltale light will go out.

If the telltale light flashes:

The system is active, that is to say it is compensating for fluctuations in traction caused by the road surface.

If the telltale light does not go out after the engine has been started or comes on during the journey:

The system is defective, but the car itself is fully operational with the exception of the ASC+T stability control function. Take the car to a BMW service station to have the fault repaired.

Operating principle

High-precision sensors monitor wheel rotating speeds. If differences are detected, the system interprets them as a sign that wheelspin is about to set in, and reduces the power input from the engine accordingly. If necessary, the rear wheel brakes are also applied momentarily to suppress wheelspin.

Although the action of this system may seem to be restricting available engine power and therefore be difficult for the driver to accept, it should be remembered that as much traction as can be achieved, and therefore optimum acceleration, are always available for the prevailing road, driving and climatic conditions, without exceeding the limits of dynamic stability.

Note:

Even with ASC+T, the basic laws of physics continue to apply. If the maximum possible speed in any given situation is exceeded, traction and lateral wheel location may be lacking. The driver alone is responsible for avoiding this situation. The additional safety potential offered by this stability and traction control system must never be understood as an invitation to take additional risks.

The system reacts sensitively if tyres of different makes and types are used on the same car. You should therefore try to ensure that all the car's tyres are identical in make, type and tread pattern.

By **switching off ASC+T** it is possible to revert to the conventional driveline (without electronic control). It may be desirable, for instance, to switch off the system to ensure maximum potential traction

- if the car has to be rocked out of a hollow on a soft surface, or started in deep snow or on a loose surface (see "Car unable to move", Page 109).
- if snow chains are fitted.

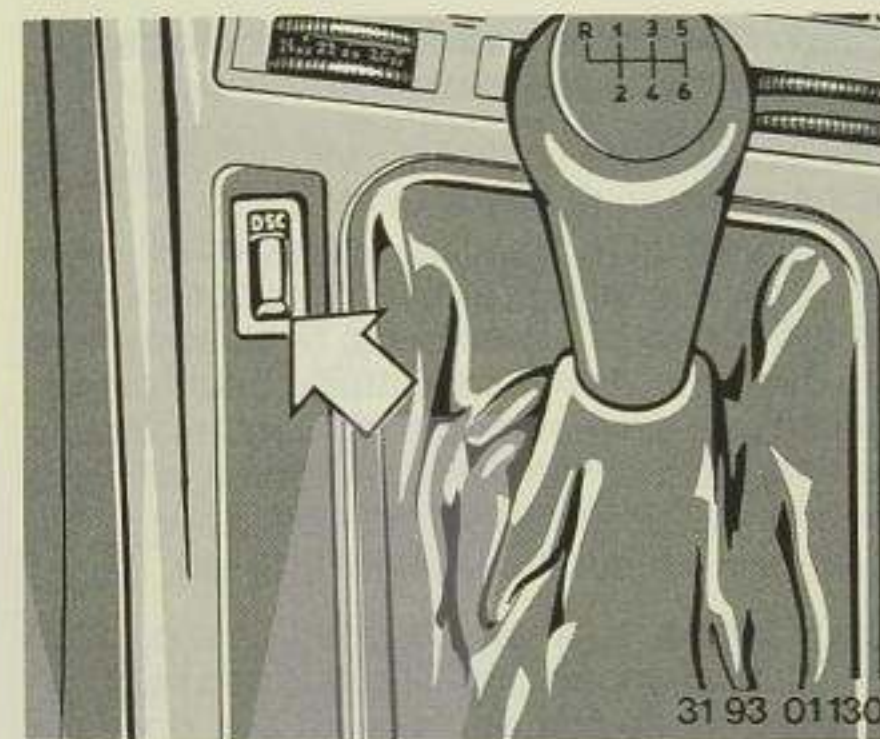
**Dynamic Stability Control (DSC)***

DSC is a further extension of Automatic Stability Control + Traction (ASC+T).

It improves dynamic stability, particularly where lateral forces are encountered (e.g. cornering) and when accelerating. It identifies and counteracts unstable driving situations and prevents the driven wheels from spinning in poor-grip or otherwise unfavourable conditions (slippery surfaces, sharp bends). It ensures that optimum use is always made of the available grip between the tyre and the road.

The system comes into action automatically whenever the engine is started.

The telltale light on the instrument panel goes out when the engine has been started.

To switch off the system:

Press the button; the telltale light will come on.

To re-activate the system:

Press the button again; the telltale light will go out.

If the telltale light flashes:

The system has identified a poor-grip situation and is regulating the transmitted power output.

If the telltale light does not go out after the engine has been started or comes on while the car is being driven:

The system is defective, but the car can still be driven normally with DSC out of action. Take the car to a BMW service station for repair.

Operating principle

Highly-sensitive sensors monitor wheel rotating speeds and the steering lock angle. If wheel speeds vary or differ from the calculated value at a given steering lock angle, the system registers the likelihood of wheelspin and reduces engine output accordingly; if necessary, either driven wheel can be braked momentarily to prevent it from spinning.

Although the action of this system may seem to be restricting available engine power and therefore be difficult for the driver to accept, it should be remembered that as much traction as can be achieved, and therefore optimum acceleration, are always available for the prevailing road, driving and climatic conditions, without exceeding the limits of dynamic stability.

Note:

Even with DSC, the basic laws of physics continue to apply. If the maximum possible speed in any given situation is exceeded, traction and lateral wheel location may be lacking. The driver alone is responsible for avoiding this situation. The additional safety potential offered by this system must never be understood as an invitation to take additional risks.

The system reacts sensitively if tyres of different makes and types are used on the same car. You should therefore try to ensure that all the car's tyres are identical in make, type and tread pattern.

By **switching off DSC** it is possible to revert to the conventional driveline (without electronic control). It may be desirable, for instance, to switch off the system to ensure maximum potential traction

- if the car has to be rocked out of a hollow on a soft surface, or started in deep snow or on a loose surface (see "Car unable to move", Page 109).
- if snow chains are fitted.



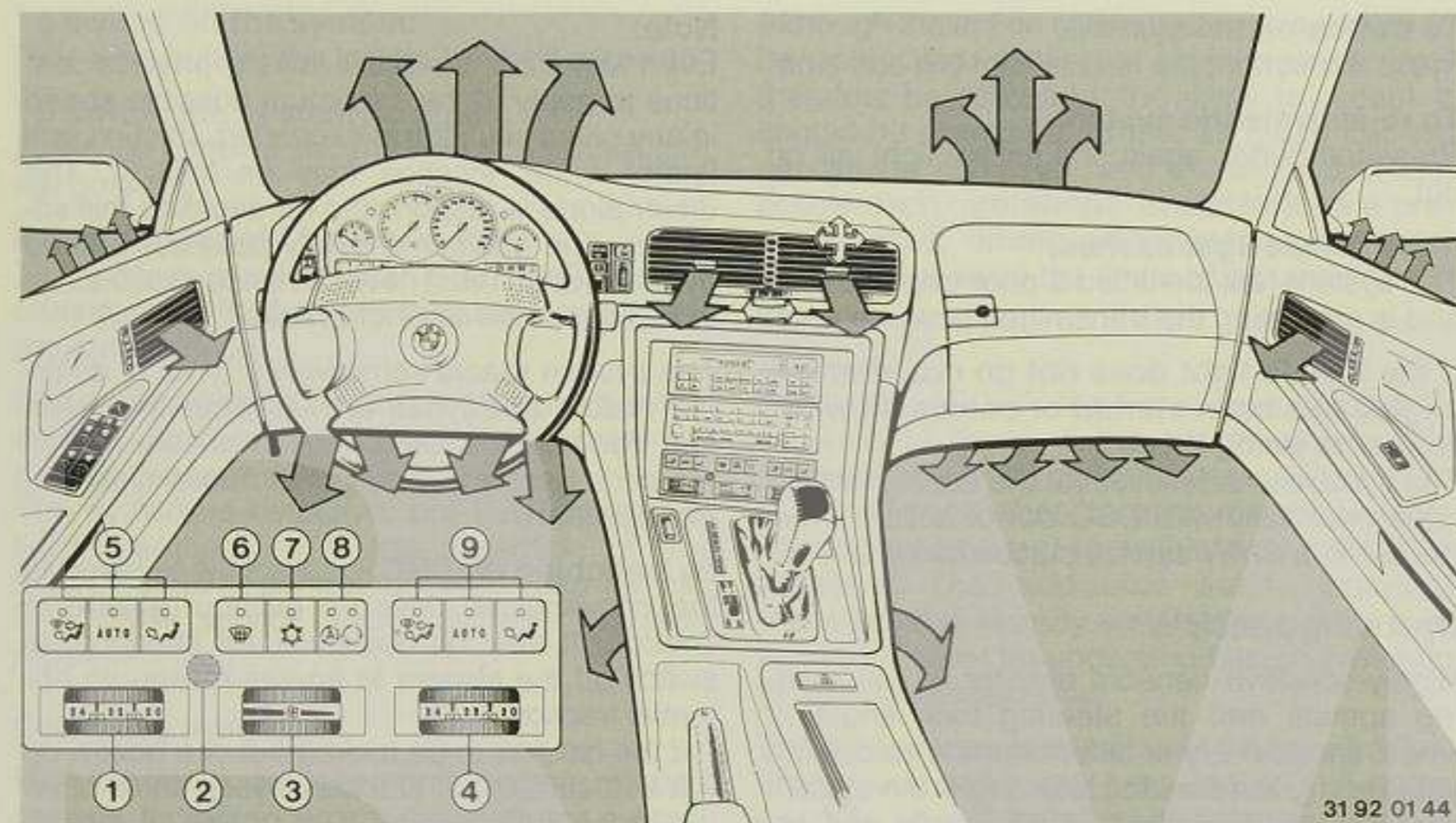

Automatic air conditioning

- 1 Temperature selector for left side of car
- 2 Air entry grille for interior temperature sensor – must not be obstructed
- 3 On/off switch and airflow volume selector
- 4 Temperature selector for right side of car
- 5 Program buttons for air distribution on left side of car

- 6 Pushbutton for maximum windscreen and side window demisting
- 7 Air conditioning pushbutton
- 8 Pushbutton for Automatic Recirculated Air Control (AUC)* or for recirculated air operation
- 9 Program buttons for air distribution on right side of car

When a button is pressed, the corresponding LED lights up if the system was switched on at the airflow volume selector (3).

Temperature selectors for left and right sides of car

The temperature control is switched on and off at the rotary knob on the driver's side:
 Left-hand limit position: no heating effect, maximum cooling output, temperature control off.
 As the control is turned to the right, away from the detent position: temperature control cuts in.
 Right-hand limit position (detent): maximum heating output, temperature control off (also emergency position if a fault develops in the electronic temperature control system).

The scales are merely intended as a guide to the interior temperature. The selected setting is reached as quickly as possible and does not normally need to be adjusted subsequently.

Alter the settings by only small amounts at a time, to avoid undesirable temperature fluctuations.

On/off switch and selector for airflow volume

Position 0: system switched off, air intake closed.
 Turned to right as far as first detent: system switched on, minimum airflow.
 Turned farther to right: airflow increases.

Right-hand limit position (detent): maximum airflow volume (also emergency position if a fault develops in the electronic blower control system).

Program buttons for air distribution to left and right sides of car

Air distribution is controlled automatically if this button is pressed.

With only a few exceptions, this program can be used in all normal driving conditions.

Depending on actual temperatures, the air inlets are opened and closed automatically.

To ensure freedom from fatigue, the system works according to the "warm feet – cool head" principle.

However, the air emerging from the facia grilles can be varied separately in temperature; see next page.

To ensure that this program can operate effectively, some of the outlet grilles in the facia and doors must always be open and the airflow volume selector should be turned past the first detent.

Air distribution through all grilles and outlets – no automatic control

This program is recommended in warm weather, for instance, if extra ventilation or cooling of the footwell areas is needed.

Note:
 If the windscreen mists over on the outside when atmospheric humidity is very high, press the AUTO program button or the button for airflow to the footwell outlets only. No cooled air will then be directed onto the windscreen.

Important:
Press this button, increase the airflow and if necessary restrict airflow out of the ventilation grilles if the windscreen and side windows mist over during a journey and it would be undesirable to press button 6 (maximum windscreen and side window demisting).

Airflow to the footwell outlets only.

The demisting outlets are also slightly open.
 This program is recommended in cool weather, for example, when airflow from the grilles is not wanted, or to heat up the footwells rapidly.

Note:
 In all programs, air emerges from the demisting outlets only at first after a cold engine has been started, until the heater matrix has reached app. 30°C.

Pushbutton for maximum demisting and drying of the windscreen and side windows

The windscreen and side windows can be cleared and dried rapidly with this program. The previously selected program is not lost. For maximum effect, the engine must be at its regular operating temperature.

Pressing this button again (the LED goes out) automatically restores the system's previous settings.

The windows mist or fog over as a result of moisture condensate caused by severe differences in temperature or a high level of humidity. The only remedy is to dry the glass with plenty of warm air.

Note:
 The first time this button is pressed after starting the engine, the rear window heating is also switched on.





Air conditioning button

When this button is pressed, the air conditioning compressor is switched on above app. +1°C outside temperature in all programs. The air is either cooled and dried or only dried as necessary.

If air humidity is very high it is wise to switch the air conditioning on in good time (before moisture condensate can reach the evaporator) and dry the air, so that the windows do not fog over. Take care not to direct **cooled** air onto the windscreen, as it could otherwise mist or freeze over on the outside.

At the maximum cooling setting, the system switches over automatically to recirculated-air operation and the defroster outlets are closed.



Pushbutton for recirculated-air operation

This is recommended if the outside air is dusty or smells objectionable. The air already inside the car then passes through the system repeatedly.

Although the air conditioning is switched on automatically at the same time to improve the quality of the air (and dry it), you should not drive for too long with the system in the recirculated-air mode.

Note:

If the windows fog over when the recirculated-air mode is in use, switch to fresh-air operation and run the air conditioning by pressing button 7.

Pushbutton for Automatic Recirculated Air Control (AUC)*

Three functions are obtained in succession by pressing this button repeatedly, and confirmed by LEDs.

Fresh-air operation: LEDs off.

Normal operation with fresh air from outside the car.

AUC operation: left LED is on.

The system identifies peak pollutant loads in the outside air and prevents them from reaching the car's interior.

A sensor measures the level of pollutants in the outside air. If the values increase, the system switches over automatically to recirculated-air operation.

Recirculated-air operation: the right LED comes on.

Note:

If the windows fog over when the AUC or recirculated-air mode are in use, switch to fresh-air operation (LEDs go out) and run the air conditioning by pressing button 7.

Noises heard after the engine has been switched off are caused by the actuating motors returning the ventilation flaps to their rest positions.

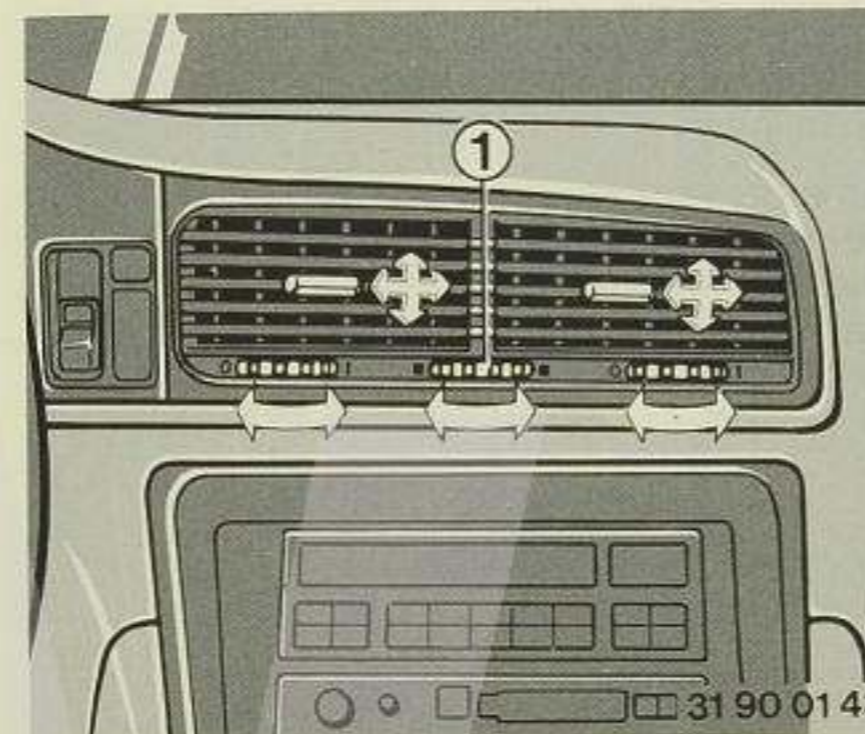
**Warm feet and a cool head:
Stratified interior air temperatures
for fatigue-free driving**

The air emerging from the facia and door grilles can be varied in temperature (except when maximum cooling is required):

Knurled wheel 1 turn to right – warmer,
turn to left – cooler.

Important notes on air conditioning system

Moisture condensate produced by the evaporator is discharged under the car and, depending on atmospheric humidity, can amount to as much as 2 litres per hour.

The air conditioning should be run for a short time at least once a month (please remember to do so in the cold months of the year as well), or else the compressor shaft seal may dry out and allow refrigerant to escape.

If the air conditioning develops any faults, switch it off and consult BMW service without delay. A fault would be indicated, for example, if no cool air is delivered even when the controls are set to the lowest possible temperature (driver's temperature control at the left limit of its travel).

Microfilter

Fresh air is drawn in through a microfilter. This filters out up to 100 % of all pollen and up to 60% of dust particles in the air.

Change the filter at the car's regular servicing intervals. If airflow is noticeably lower than usual, this may indicate that the filter should be renewed earlier.

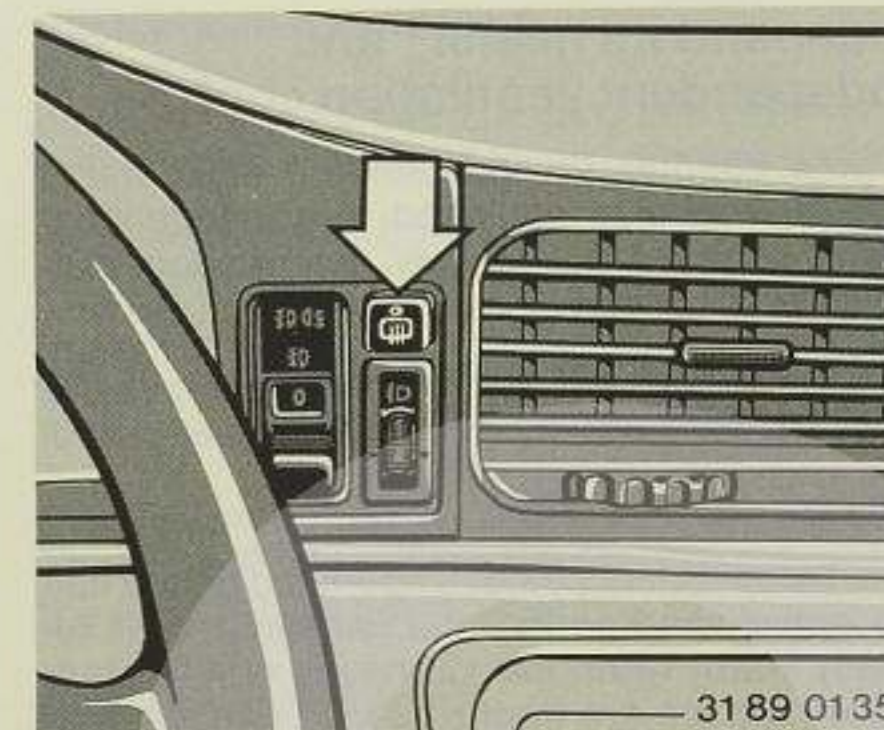
**Heated rear window**

Press the button: While the telltale light is on, the heated rear window is operating at full power (for rapid demisting).

When the telltale light goes out, the heated rear window has switched over automatically to a low rating in order to save power. It cuts out completely after about 20 minutes unless switched off previously.

If necessary, press the button again:
This will start a new rapid demisting cycle.

To switch off: Press the button if the telltale light is on.

Whenever the engine is restarted, the heated rear window has to be switched on again if still required.

Independent heater* and independent ventilation control*

If your car has an independent fuel-burning heater, it is also equipped with independent ventilation control. However, independent ventilation control can also be installed on its own.

Both systems are operated by way of the on-board computer; see Page 50.

Independent heater

The independent heater's operating period can be preselected so that the car's interior is already warm when the journey is due to start. Snow and ice are then easier to remove from the windows.

The heater runs for 30 minutes at a time. Since its current consumption is high, it should not be run twice in succession unless there has in the meantime been an opportunity to recharge the car's batteries by a period of driving at reasonable speeds.

The heater can also be switched on and off directly.

The independent heater can be run at outside temperatures below 16°C, but not while the car is being driven.

The heated air is supplied automatically to the car's demisting and footwell outlets; the heater runs at maximum output in all cases.

In ignition key position 1 you can vary the interior temperature (at the temperature selectors) and the air distribution (by means of the push-buttons).

After it has cut out or been switched off (LED off) the independent heater continues to run for a short period.

If the independent heater does not start after a maximum of **two attempts**, or switches itself off automatically, consult a BMW service station.

Note:

Even during the warm season of the year the independent heater should be run briefly about once a month.

To do this if the temperature is above 16°C:

- Press the **TIMER** and **TEMP** buttons on the on-board computer at the same time: the "INV" (inverted) inscription will appear.
- Switch the independent heater on directly, and switch off again after about 5 minutes.

Warning:

Never operate the independent heater in an enclosed space.

Always switch off the independent heater before refuelling the car.

Independent ventilation control

This system supplies air to the interior and lowers its temperature by means of the automatic air conditioning fan.

The switch-on time can be preselected; the system runs for a period of 30 minutes. It can also be switched on and off directly. Since its current consumption is high, it should not be run twice in succession unless there has in the meantime been an opportunity to recharge the car's batteries by a period of driving at reasonable speeds.

Independent ventilation control is available at outside temperatures above 16°C, but not when the car is being driven.

Air is delivered to the controlled-output, variable-direction grilles in the fascia and doors. These grilles must therefore be opened before the independent ventilation control is switched on or preselected.

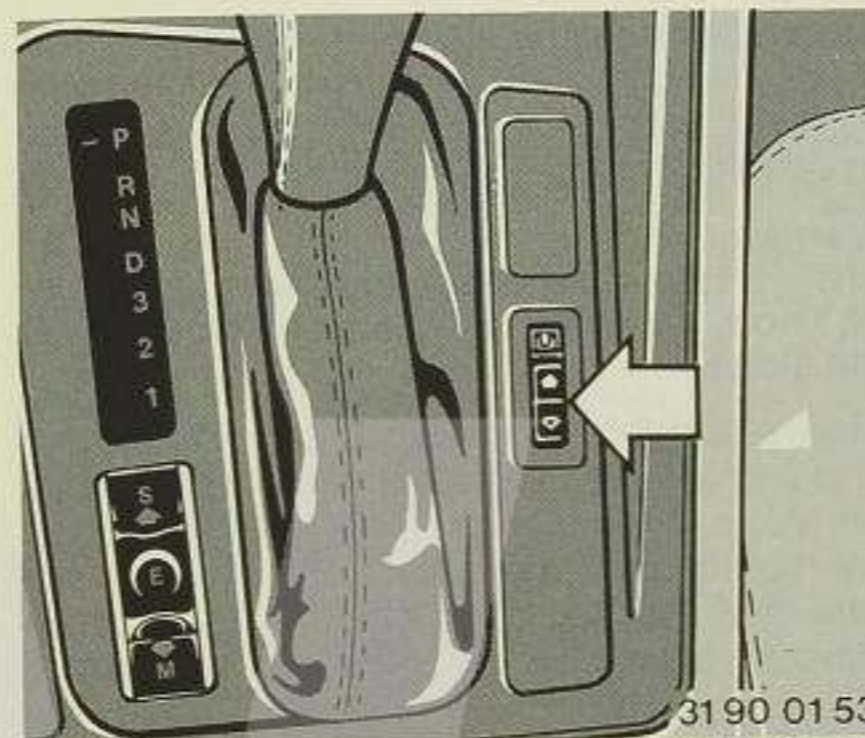

Electric roller sun blind for rear window*

To operate, touch the rocker switch; the ignition key must be in position 2.

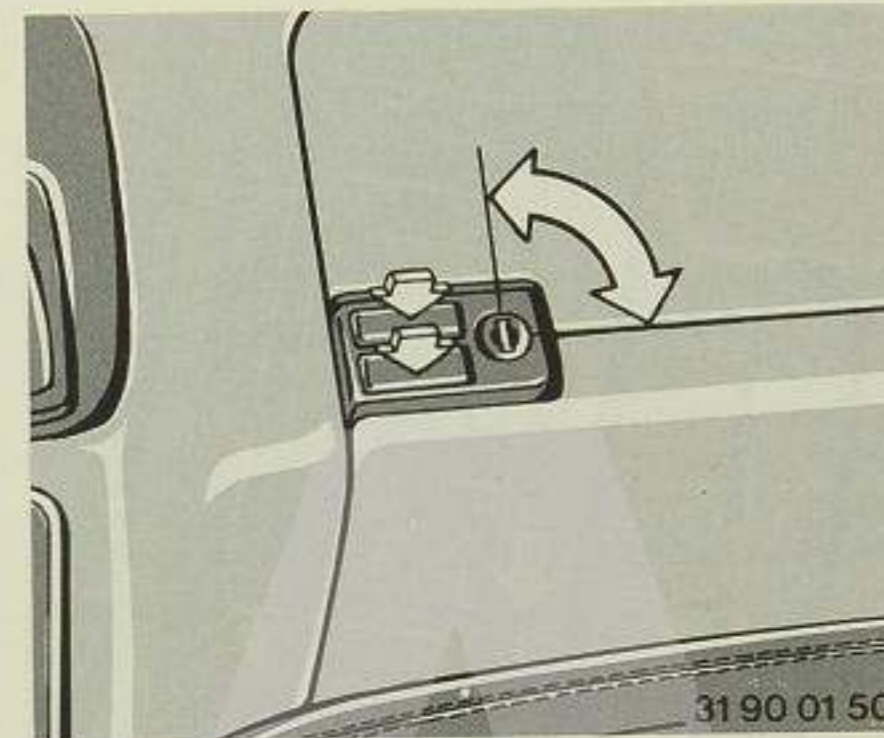

Glove boxes

To open: Press the appropriate catch. The light inside will come on automatically.

To close: Shut the lid.

To lock: This is only possible with the central key. **When the glove boxes are locked, the luggage compartment is also locked.**

Warning:

To avoid risk of injury, the glove boxes should be kept closed when not in use.

Rechargeable hand lamp

This is located in the lower glove box. It is protected against overcharging and can therefore remain in its socket for an unlimited period.

However, it must be taken out if the batteries are disconnected or removed.

Important:

Always switch the lamp off before inserting it into its socket.

Drinks can holders

There are 2 fold-out holders for drinks cans on the inside of the lower glove box lid.

Further storage space

In the compartment on the centre console and in the pockets on the doors and front edge of the front seats.



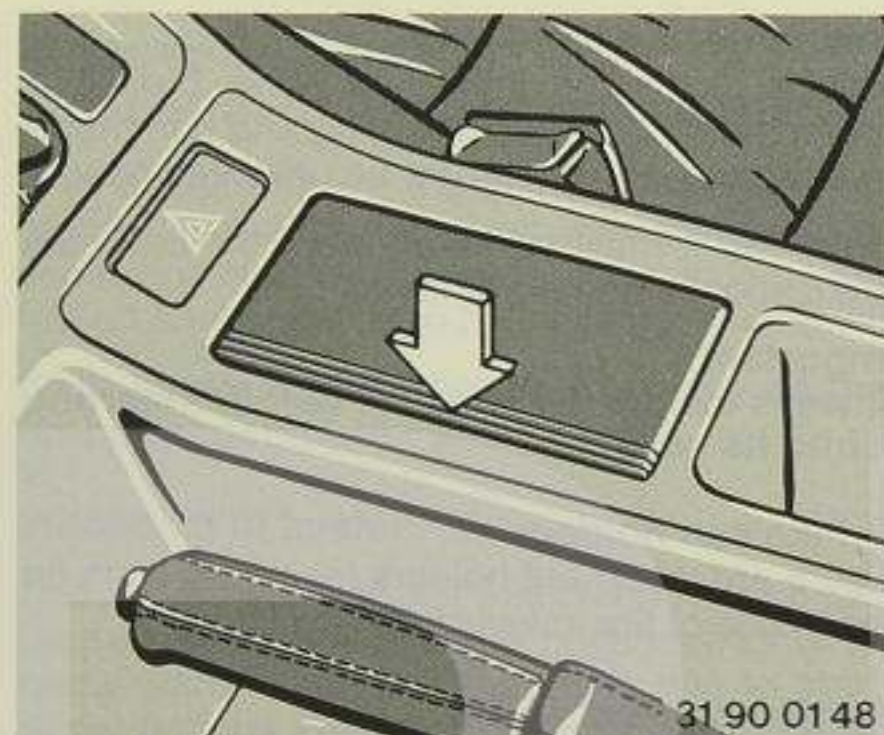

31 90 01 48

Ashtray

To open: Press down on the left of the lid (arrow).

To extinguish a cigarette, knock off the ash and insert only a short distance into the funnel-shaped hole.

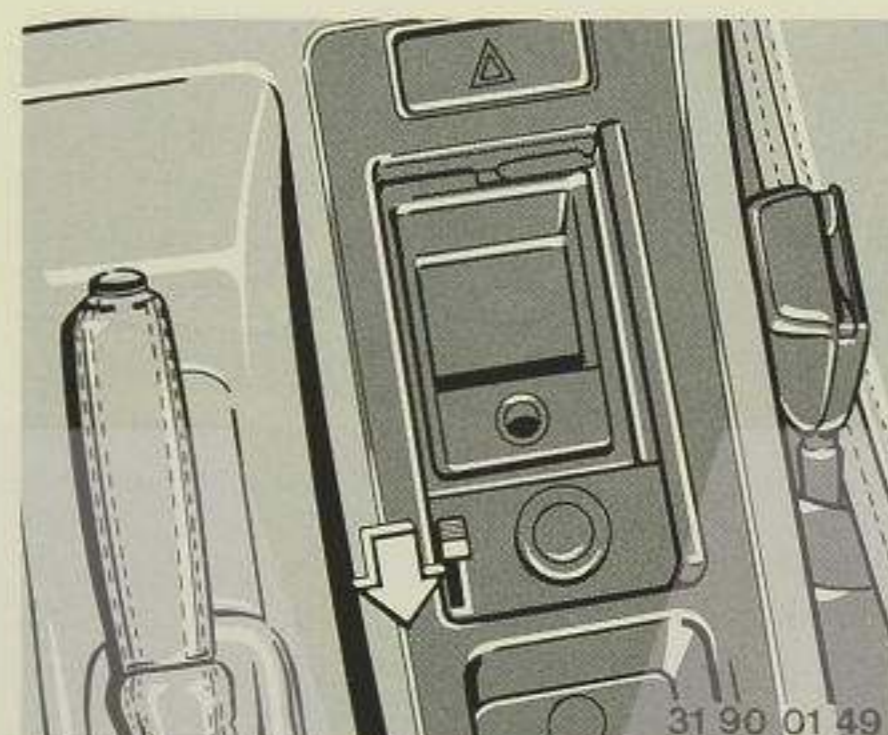

31 90 01 49

Cigarette lighter

Press in to operate. The element will then heat up; the cigarette lighter can be removed when it pops back out.

Warning:

Always take hold of the cigarette lighter by its knob, never by its heating element or at the sides.

Cigarette lighter socket

This can also be used to power a hand lamp, a car vacuum cleaner or similar items rated at not more than 12 Volts, app. 200 Watts. Make sure that the socket is not damaged by attempting to insert plugs of the wrong pattern.

Warning:

The cigarette lighter remains operational when the ignition key has been removed. For this reason too, children should never be left in the car unattended.

To empty: With the ashtray open, move the lever in the direction of the arrow. The ashtray can then be removed.

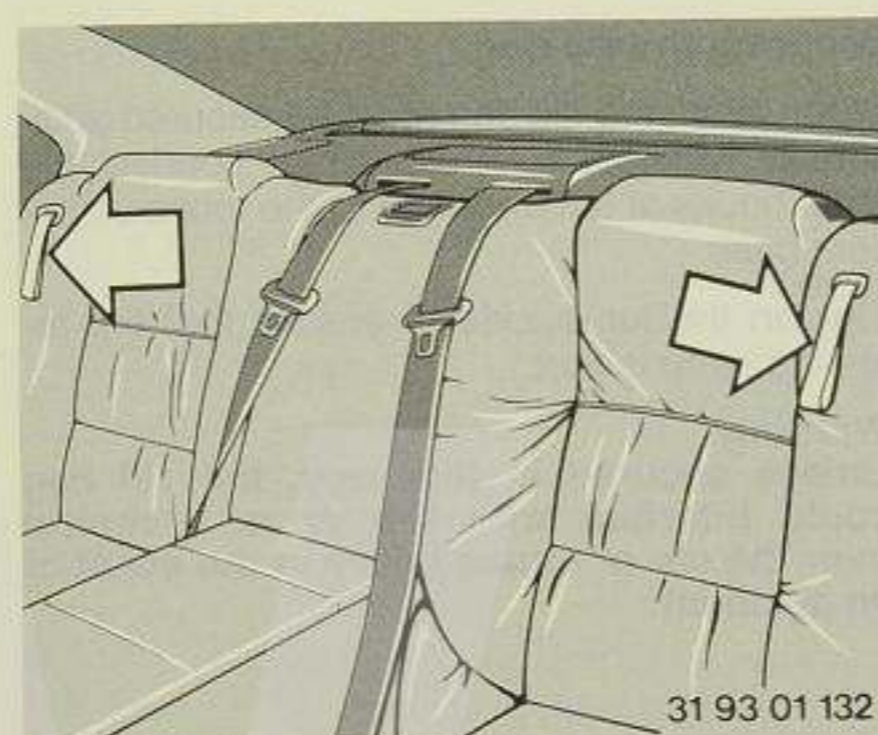

31 93 01 132

Folding rear seat backs*

So that items of luggage of moderate size can be carried, the left and right seat backs can be folded forwards after pulling the strap (arrow).

When raising the seat back, make sure that it is heard to engage in position.

Ski bag*

This enables 3 to a maximum of 4 pairs of skis to be carried safely and without being exposed to dirt.

Together with the available length inside the car's luggage compartment, skis up to 2.10 m long can be carried in the ski bag. Note, however, that when several pairs of skis are inserted the tapered section of the bag reduces the overall carrying capacity, so that for example only 2 pairs of 2.10 m long skis can be carried.

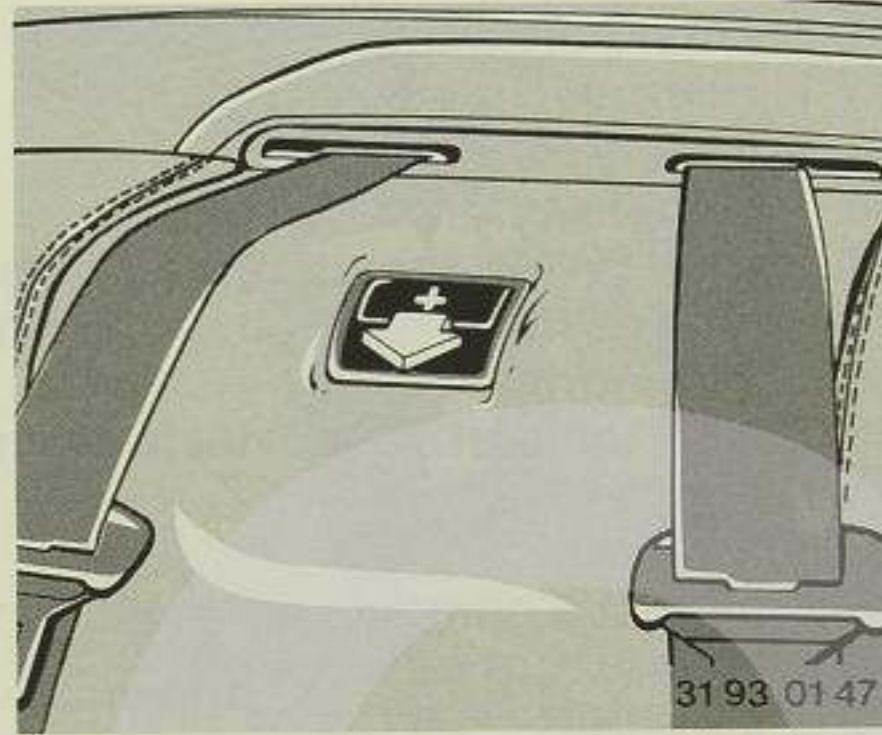

31 93 01 47

Inserting items into ski bag

Pull the release lever (arrow). Swing the centre section of the seat forwards, complete with its integral first-aid box, and lift it out.

Note:

When installing the centre section again, insert it into the lower guides first and swing it back until it is heard to engage in position.



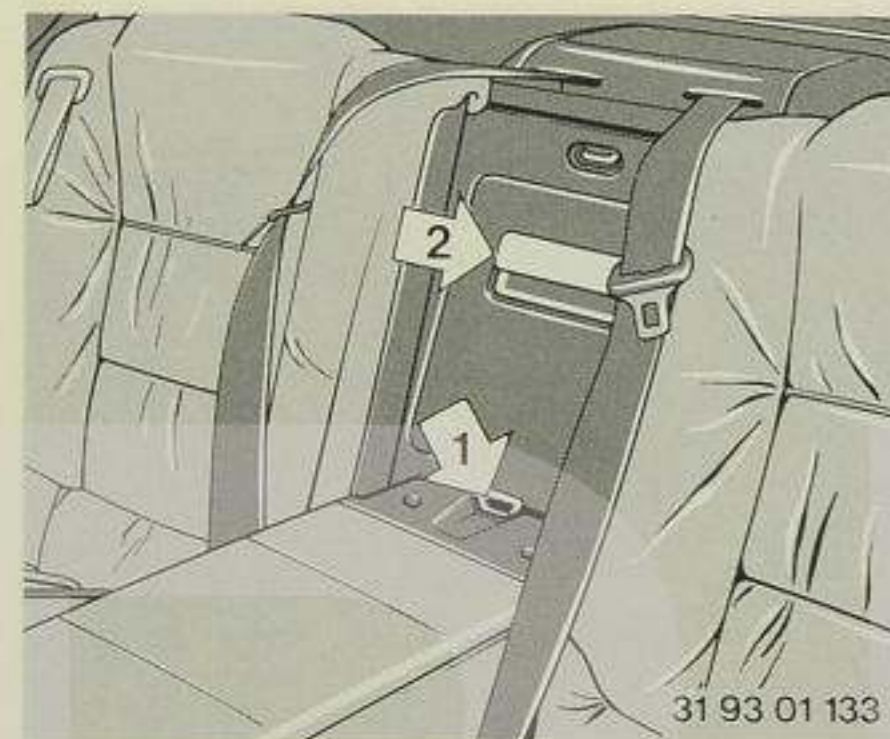

Press the release catch (arrow 1): this will release the loading flap in the luggage compartment.

Open the cover inside the car (arrow 2) and swing it down.

Pull the ski bag out between the front seats. It has a zip fastener for better access to the items inside, and for use when the bag needs to be dried out.

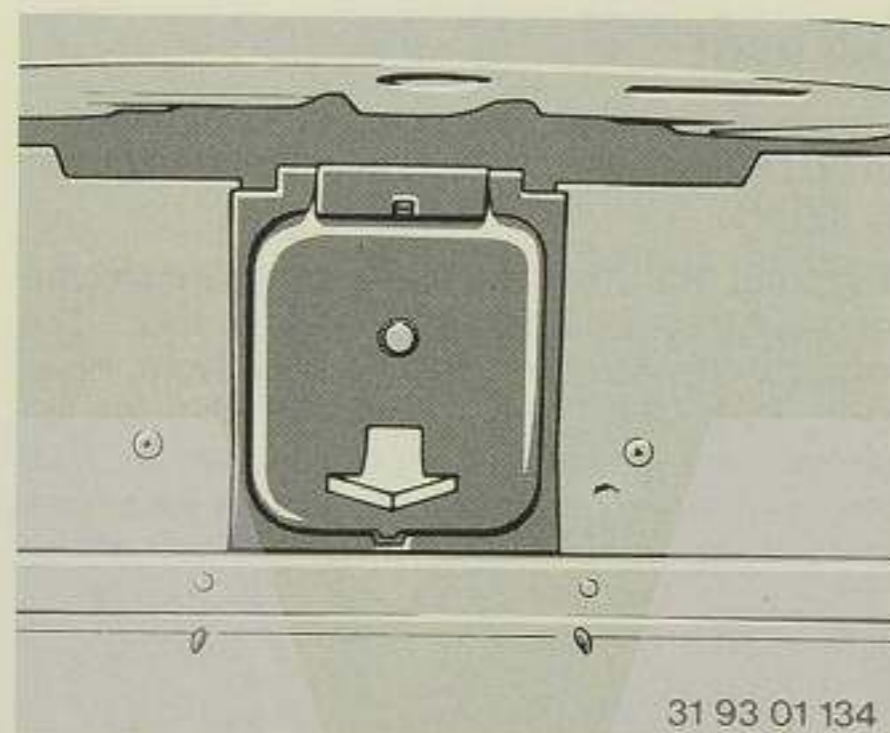

Securing the ski bag

When filled, the ski bag must be secured additionally with the retaining strap; connect the snap hooks at left and right to the loops on the seat base.

Tighten the turnbuckle to ensure that the retaining strap is taut.

Warning:

Unless secured in this way, the ski bag could interfere with the driver's control over the car or cause injury in the event of an accident.

From the luggage compartment side, attach the cover flap to the underside of the rear-window shelf with the magnetic holder provided.

Make sure that the skis are clean before they are inserted into the sack, and that any sharp edges on them or their bindings do not damage or pierce the ski bag.

Although the ski bag is waterproof, you are recommended to remove melted snow and ice or moisture condensate from it after use, and dry it out.

If the ski bag is not to be used for a considerable time, it must be dry before it is rolled up and stowed away.

Driving hints	76
Car radio operation	78
Car telephone	79
Engine compartment lid	80
Vehicle identification number, type plate, engine compartment	81
BMW 840Ci	81
BMW 850Ci/850CSI	82
Engine oil	83
Oil for brake system and steering hydraulics, AHK	86
Brake fluid	87
Coolant	88
Washer fluid for the cleaning systems	89
Power steering, brakes	90
Batteries	91
Fuses, toolkit, warning triangle, fire extinguisher	93
First aid box	94
Towing eyes	94
Tow-starting, towing away	95
Starting with a flat battery	96
Changing a wheel	97
Thiefproof wheel studs, manual operation of equipment after electrical failure	100
Renewing wiper blades, bulb-changing	102
Winter operation	107
Towing a trailer	110
Roof rack	112
Resetting headlight beams for right/left rule of the road, licensing car for use abroad	113
Antilock brake system (ABS)	114
Active Rear Axle Kinematics (AHK)	115
Disc brakes	116
Tyres	118



Driving hints

Engine

Do not warm the engine up at idle speed.

The only exception is if the outside temperature is extremely low, in which case the engine may be run for about half a minute at a fast idle speed to ensure that all points in the lubrication system are supplied with oil.

Never run a cold engine at high speeds, as this will have an adverse effect on operating life.

When the load on the engine is high (acceleration, hill-climbing), try to use engine speeds above 1500/min and shift down to a lower gear in good time, particularly on gradients.

After a fairly long section of a journey spent at low speeds (heavy town traffic, nose-to-tail traffic), try to cover a few kilometres at engine speeds above 3000/min. This will help to eliminate soot deposits in the engine.

Clutch

When declutching, press the pedal down fully. Do not rest your foot on the pedal in normal driving.

Warning:

You should never rest your foot on the brake pedal either when the car is being driven. Even slight continuous pressure on the brake pedal could cause overheating, brake pad wear or even brake system failure.

Aquaplaning:

When driving on a wet road or one covered in slush, a wedge of water tends to form between the tyre and the road. This situation, known as aquaplaning, means that the tyre can actually lose contact completely with the road surface, so that the car can neither be steered nor braked properly. You should therefore always reduce speed on a wet road.

Rear-window shelf:

Never place hard or heavy objects on the shelf below the rear window, or they could be dislodged when the car is braked heavily and endanger the occupants.

Coat hooks:

If clothing is attached to these hooks, make sure it does not obstruct the driver's view. Do not hang heavy objects from them, to avoid the risk of personal injury if the car is braked suddenly.

Cars with catalytic converter

The catalytic converter reduces pollutant emissions in the exhaust.

Cars equipped in this way must **always be run on unleaded fuel only**.

Even small amounts of lead in the fuel can permanently damage the lambda probe and the catalytic converter.

To ensure that the **engine always operates correctly and reliably** and to avoid damaging it, the following instructions should be complied with:

- Always have the specified maintenance work carried out at the stated intervals.
- Do not run the fuel tank dry.
- Switch off the engine at once if misfiring occurs.
- Never tow-start the car unless the engine is cold, or else unburned fuel may reach the catalytic converter. It is always preferable to use jumper leads from another car or a separate battery to start the car.
- Avoid any other situations in which unburned or only partially burned fuel could pass through the engine, for example:
 - Frequent operation of the starter for very short periods or repeated attempts to start if the engine does not fire. (However, switching off an engine which is running normally and restarting it again shortly afterwards is perfectly acceptable.)
 - Running the engine with a spark plug lead detached.

If unburned fuel reaches the catalytic converter as a result of misfiring or fuel-air mixture preparation malfunctions, overheating and damage may result.

Warning:

High temperatures build up at the catalytic converter (as on all cars with this form of exhaust emission control). Make sure that no easily combustible material (for example hay, leaves, grass etc.) comes into contact with the hot exhaust system when the car is driving, idling or parked. If this material were to ignite and cause a fire, very severe injuries or damage could result.

Do not remove the heat shields from the exhaust system, or apply underseal to them.

Engine refinement is influenced by the exhaust emissions purification technology, fuel consumption and the quality of the fuel used. The modified operating conditions are largely taken into account by the electronic measuring and control functions and the high-quality design and workmanship of individual components, e.g. in individual features such as the electronic ignition and fuel injection system.

Any unusual responses on the part of the engine or the car, for instance when accelerating at a low engine speed, as combustion sets in again following fuel cutoff while coasting or at low running speeds are all part of the compromise between the need for low fuel consumption, improved environmental acceptability and luxury driving and do not call for any adjustment or remedial action.

If the Digital Motor Electronic engine management system, which normally ensures that all engine operating settings are optimized, is separated from the power supply (for instance if the batteries are disconnected), the engine may not idle smoothly for a short period after the system has been re-energized. Stable idling is obtained only after the engine has passed through various adaptive phases at its normal operating temperature, as part of the regular driving routine.



Car radio operation*

For adjustments to your car radio and correct operation of its controls, please refer to the accompanying operating manual.

The radio's reception and reproduction quality depend on the car's position in relation to the transmitter and on the height and direction of the aerial.

Certain concessions are unavoidable in the case of a car radio. The car's position is constantly changing and a directional aerial cannot therefore be used. Interference from high-tension overhead wires, vehicles with poor interference suppression on their electrical systems, but also buildings and natural obstructions to the radio signal from the transmitter can all create noise and cause signal deterioration which cannot be entirely eliminated at the receiving end.

Climatic influences such as fog, rain or snow can also affect radio reception.

As the **sun's activity** increases, reception quality on the long, medium and short waves is adversely affected. Reception is best on these wavebands after dark, when the radio signals from the transmitter are reflected back to earth more powerfully by the ionosphere.

The MW, LW and SW wavebands can be heard a long way from the transmitter, because the signals spread out both as **ground waves** and **through the air** – reflected by the ionosphere.

For reasons associated with the laws of physics, reception on the **medium waveband** is not of such high quality as very high frequency (VHF) reception using the FM principle. Since medium-wave transmitters can be picked up a long distance away, particularly at night, a wide variety of listening material is always available, but interference between closely-spaced transmitters is a frequent problem.

Unlike VHF reception, audio reproduction on medium wave may seem rather lacking in treble to the listener.

The range at which **long wave transmitters** can be picked up is even greater than that of medium wave transmitters.

The **short wave band** has the most extensive range of all. Most transmitters and – subject to physical limitations – the best quality of reproduction can be obtained in the 49-metre band.

VHF (FM) reception provides far higher listening quality than any of the AM wave bands. However, relatively few transmitters can normally be picked up satisfactorily at any one time, since the signals travel only by **line of sight** and their range is limited to about 80 kilometres. As the distance from the transmitter increases, disturbance in the form of noise becomes more severe, or the transmitter may fade completely or be displaced by a more powerful one as the car approaches it. When deterioration of this kind sets in, switch to another frequency.

When listening in on VHF (FM), you will have to switch to another transmitter quite frequently on a long journey.

Stereo reception is only possible on VHF. As the car moves away from the transmitter, interference tends to occur rather earlier than with mono transmissions. In this case, switch to mono reception temporarily or choose another station with a stronger signal which is broadcasting in stereo.

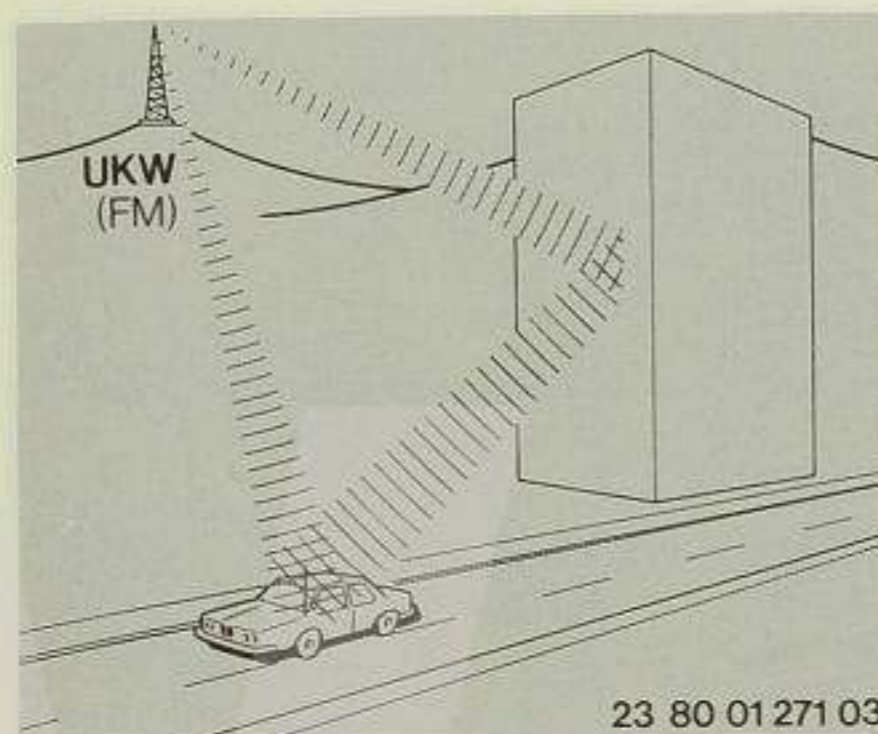

Noises best described as **hissing, splashing or flutter** are heard if reflections, for instance from roadside buildings, cause the car radio to pick up the same signals twice within a fraction of a second. Signal volume also fluctuates rapidly.

Continuous hiss usually occurs when the limit of a transmitter's range is exceeded, or in a large shadow where direct reception is poor. The only permanent cure is to retune to a stronger signal.

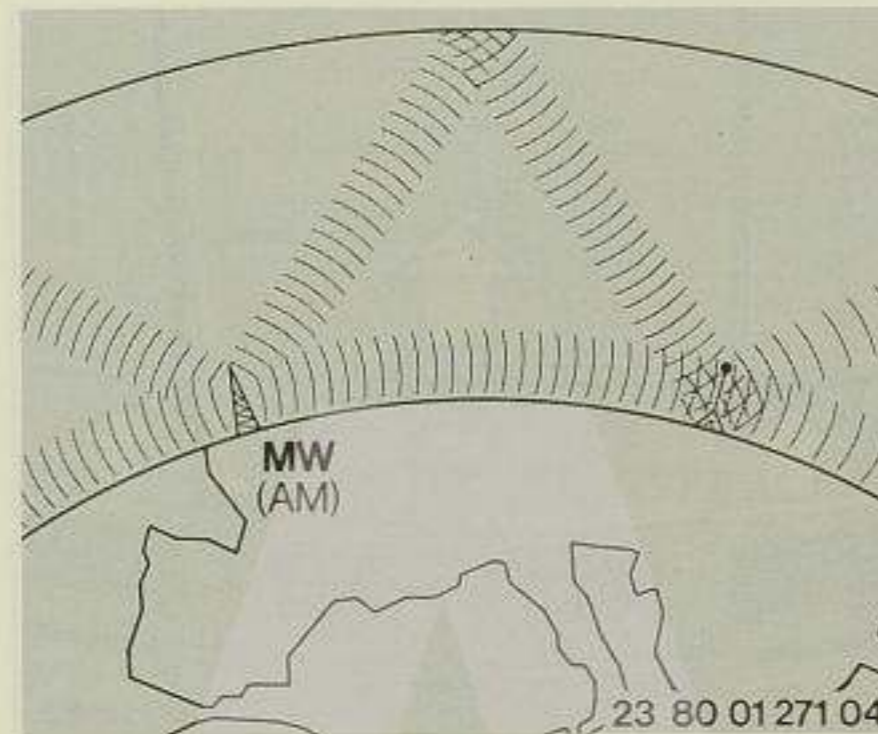

Fading - a particular problem on medium wave (MW) occurs when the ground and airborne radio waves are superimposed at the receiver. It is usually accompanied by distortion.

Flutter is heard when the direct line between transmitter and receiver is obstructed by large buildings or natural obstacles. A regular pattern of flutter is sometimes heard when driving down a road lined with large trees.

Car telephone*

Note: Mobile communication systems (car telephones, two-way radio etc.) can cause interference if they are not approved for use in your car. Since BMW cannot examine and test each product, it is unable to accept any responsibility for the installation of items it has not approved. Before purchasing any such equipment you are recommended to consult your BMW Service station.

Furthermore, in order to safeguard your BMW's operating reliability, do not operate any in-car telephones or other mobile radio equipment with an aerial **inside** the car or with an aerial which is not attached to the outside of the car.



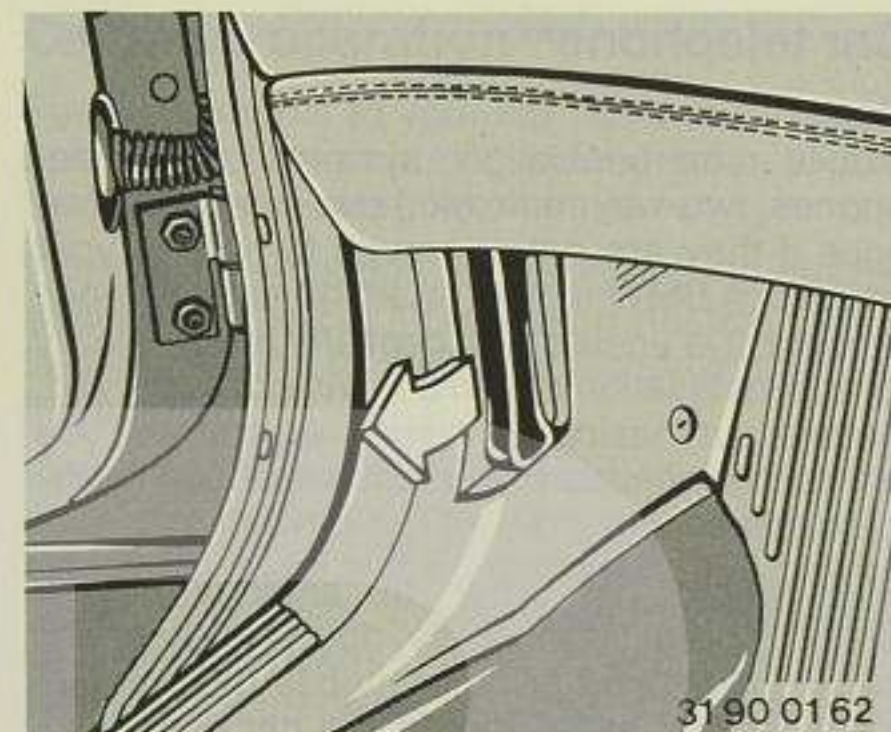

Engine compartment lid

Releasing: Pull the lever on the left under the fascia.

Warning: Switch off the engine and allow it to cool down before undertaking any work inside the engine compartment.

Always disconnect the batteries before any work is commenced on the electrical system, particularly inside the engine compartment.

Careless handling of parts or materials when working on the car represents a personal safety hazard. Please study and comply with the relevant instructions and recommendations in all cases. If you are not familiar with the regulations which could be applicable in a specific situation, you are recommended to entrust the work to a BMW service station.

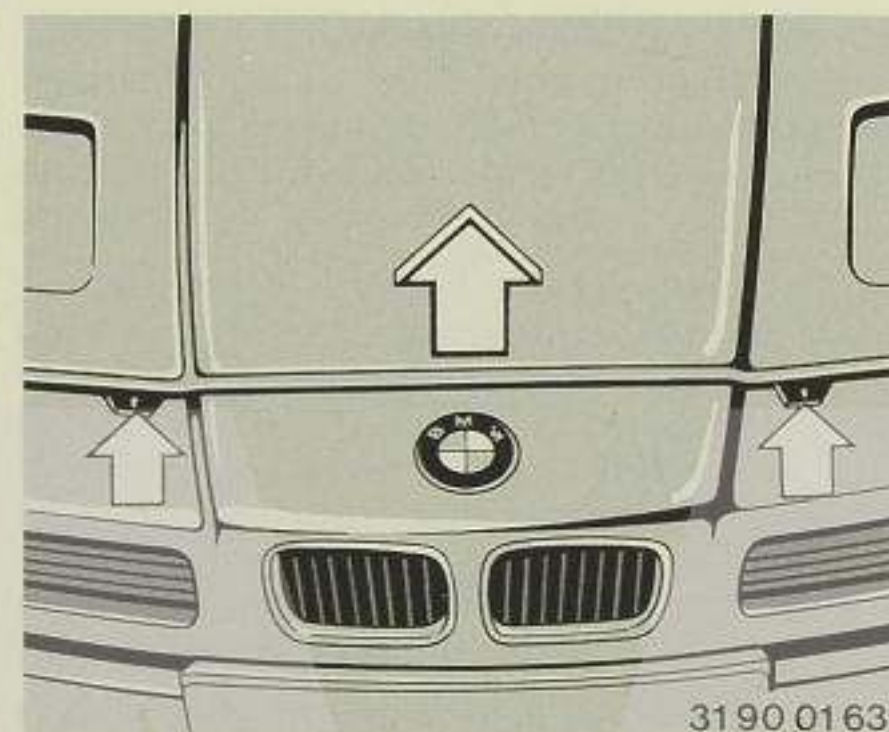

To open: Press the two sliding catches (arrows) to the rear and raise the lid.

Engine compartment light

This comes on when the engine compartment lid is raised, if the car's main lights are on.

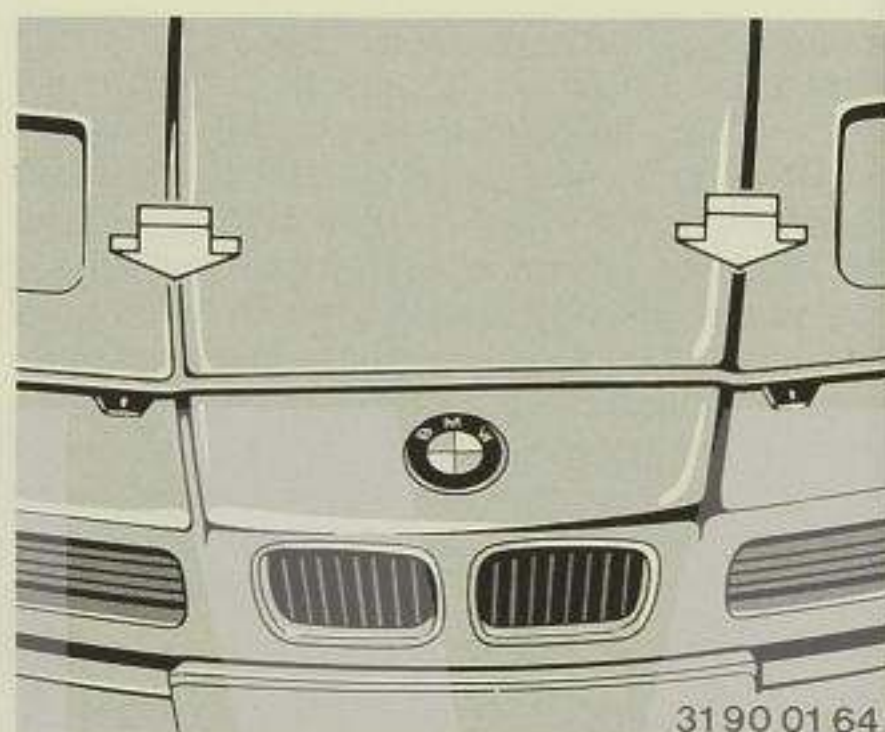

To close: Press the lid down evenly on both sides until the catches are heard to engage.

Warning:

When closing the engine compartment, keep the hands clear of the apertures for the pop-up headlights, or injury may result. Should you notice while driving the car that the engine compartment lid is not properly secured, stop at once and close it correctly.

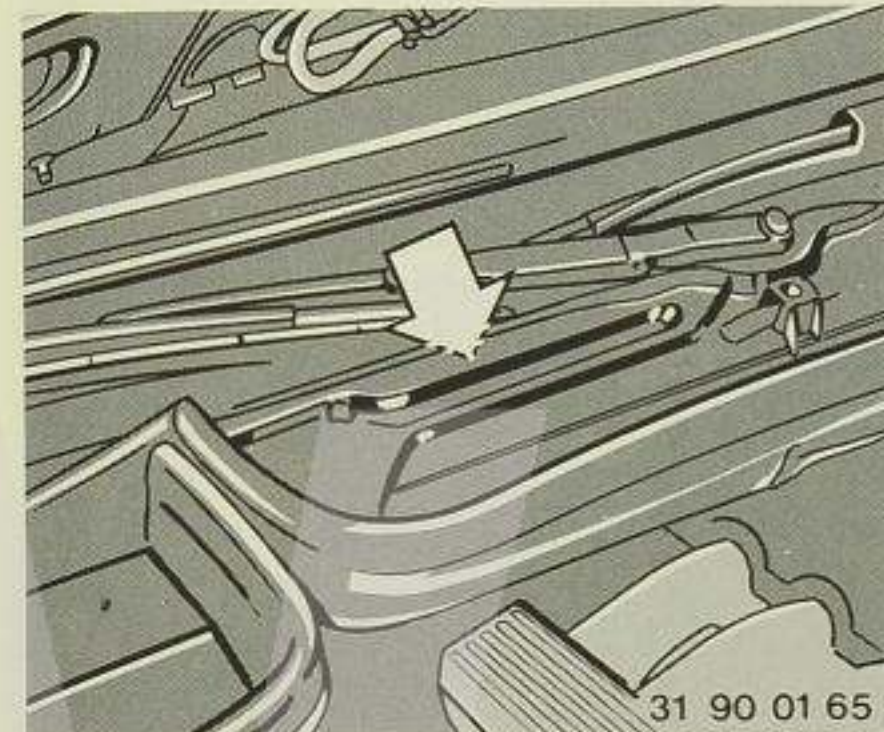

Vehicle identification number

This is located in the engine compartment, behind a gusset plate and next to the right windscreen wiper pivot shaft (arrow); it may also appear on the top of the fascia, at the left.

Type plate

In the engine compartment, on the right side panel next to the rear edge of the right pop-up headlight unit.

The details shown on the type plate, and the vehicle identification number, must correspond with those in the car's documents.

The car's data are needed as a reference for all queries, checks and spare part orders.

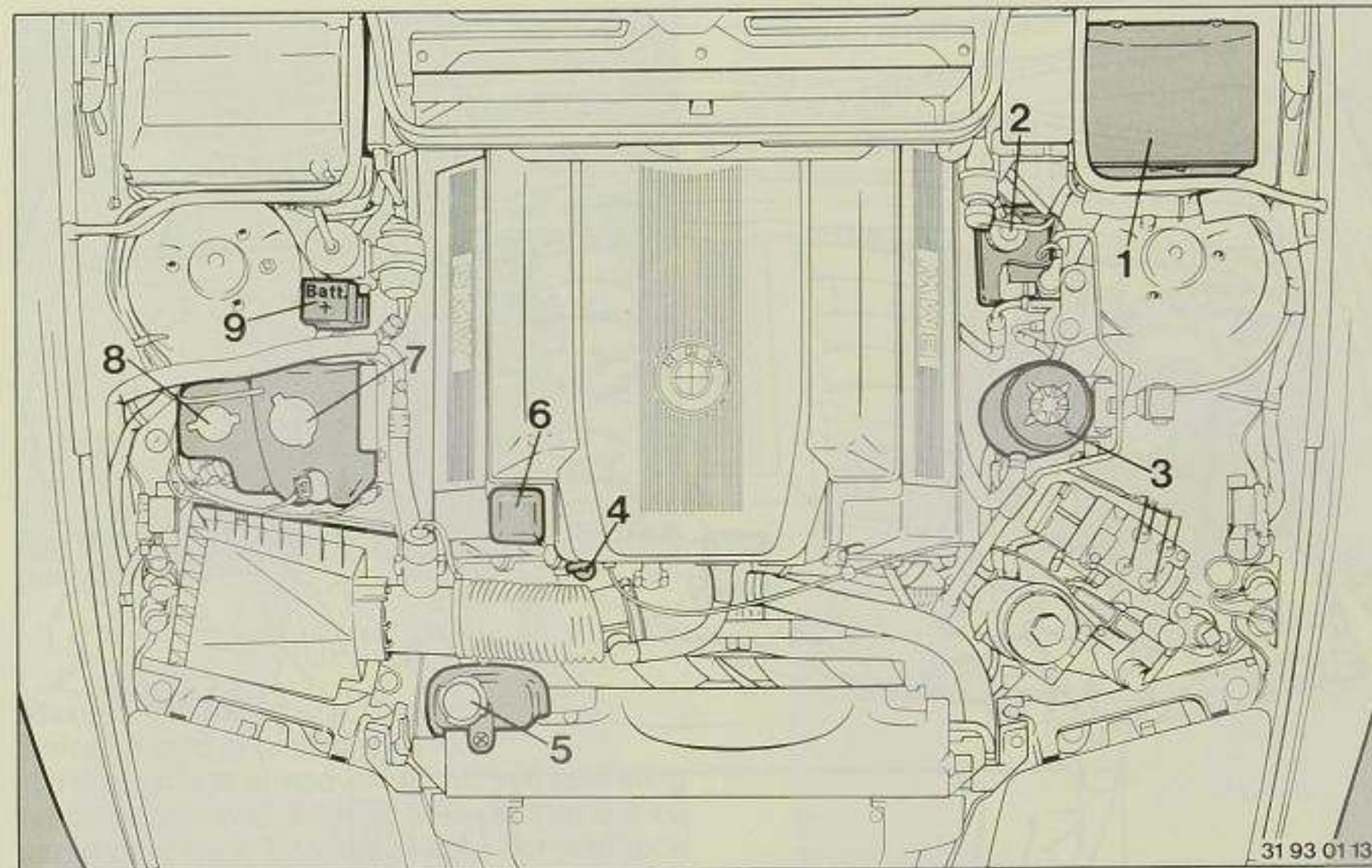

Engine compartment, 840Ci

- | | |
|--|---|
| 1 Fuse box | 7 Windscreen washer fluid reservoir (The reservoir for the headlight cleaning system is in the luggage compartment) |
| 2 Brake fluid reservoir | 8 Reservoir for intensive cleaning system |
| 3 Oil reservoir for brake system and steering hydraulics | 9 Positive pole connection (for starting with a flat battery) |
| 4 Engine oil dipstick | |
| 5 Coolant level equalizing tank | |
| 6 Engine oil filler cap | |

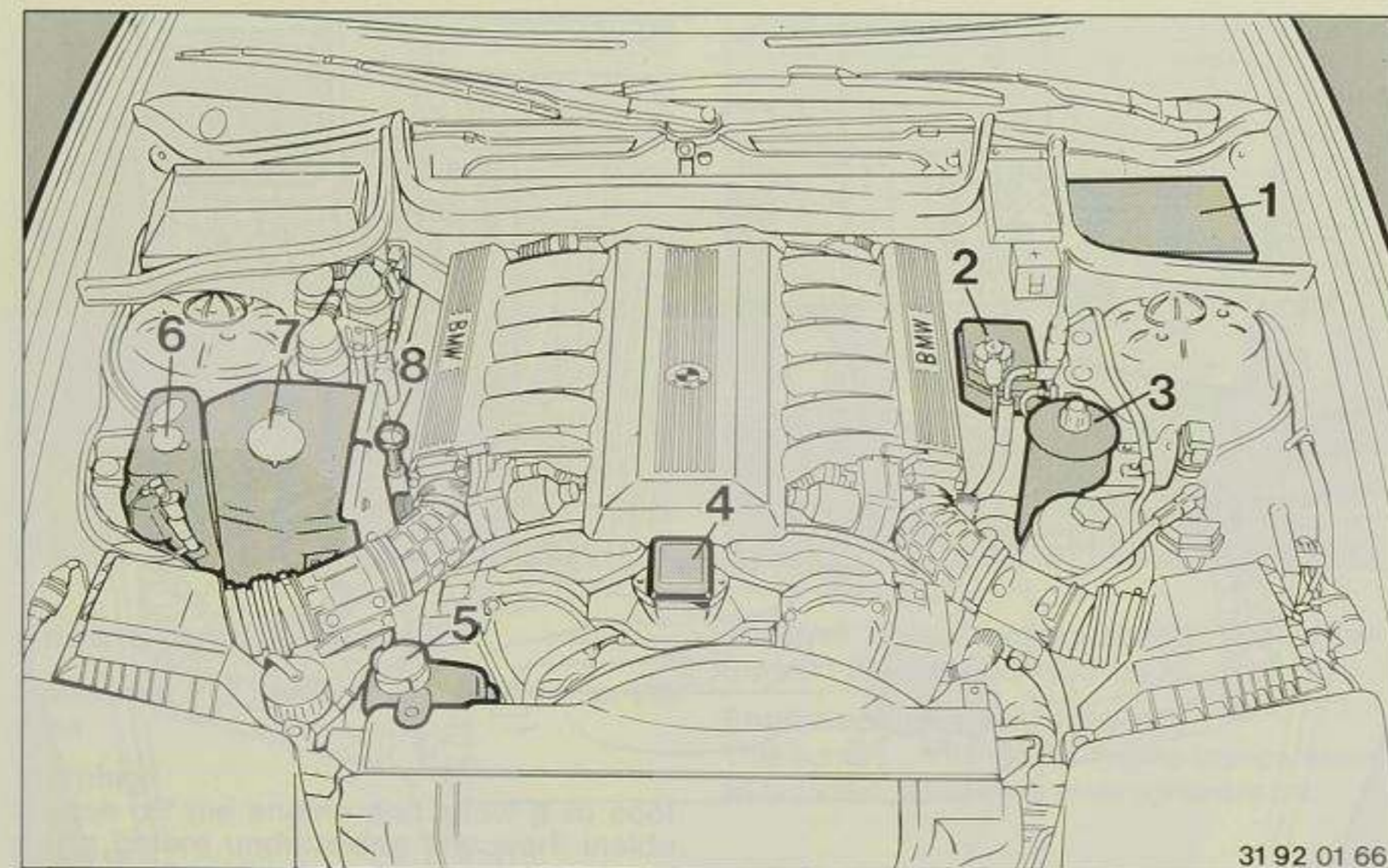

31 92 01 66

**Engine compartment,
850Ci/850CSi**

- 1 Fuse box
- 2 Brake fluid reservoir
- 3 Oil reservoir for brake system and steering hydraulics
- 4 Engine oil filler cap
- 5 Coolant level equalizing tank
- 6 Reservoir for intensive cleaning system
- 7 Windscreen washer fluid reservoir
(The reservoir for the headlight cleaning system is in the luggage compartment)
- 8 Engine oil dipstick



BMW 840Ci

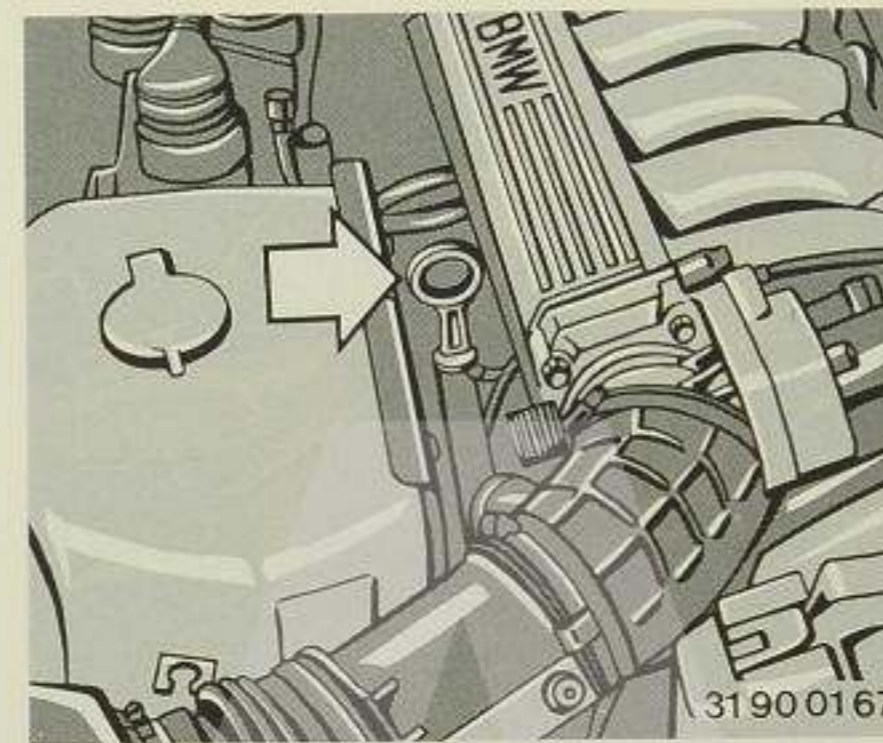

BMW 850Ci/850CSi

Engine oil

Checking engine oil level

Like fuel consumption, engine oil consumption depends on driving style and operating conditions.

The oil level should therefore be checked regularly, approximately every 1000 km (approx. 600 miles), or sooner if the engine has been driven hard. The car should stand on a flat, level surface.

Maximum measuring accuracy:
Before a cold engine is started.

If the engine is already at its normal operating temperature, wait a short time so that the oil can drain back into the sump (for instance while refuelling).

Push the dipstick fully down into its tube.

The oil level must be between the two marks on the dipstick.



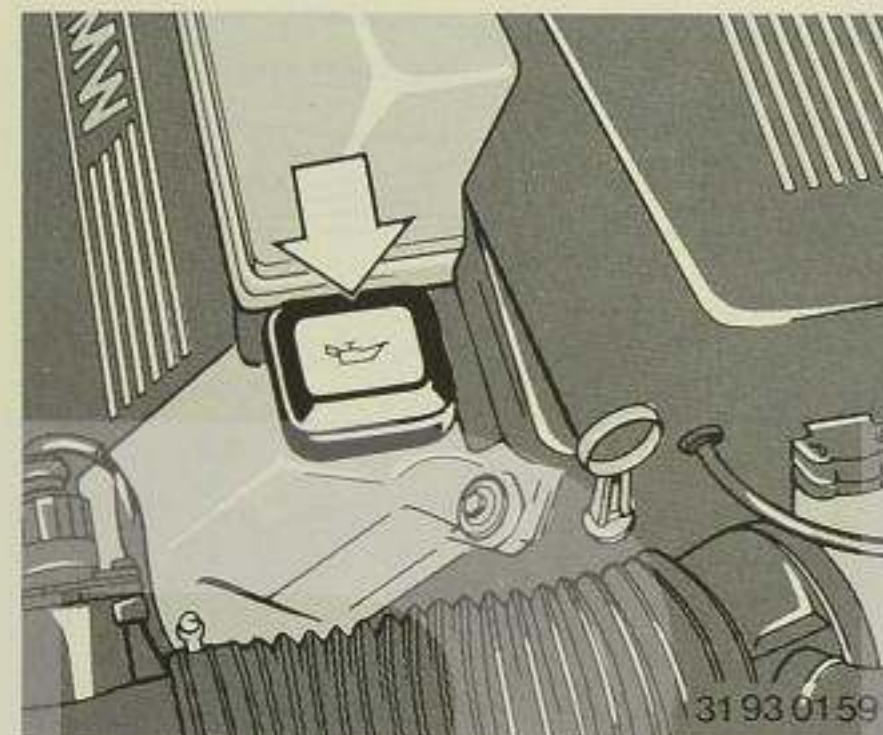

BMW 840Ci

Adding engine oil

Do not add oil until the level has fallen almost to the lower mark on the dipstick. **However, do not allow the oil level to fall below the minimum level mark.**

The space between the two dipstick marks represents approx. 1 litre of oil. **Never add oil beyond the upper dipstick mark.** Adding too much oil will harm the engine and be burned off more rapidly, thereby implying incorrectly that the engine's oil consumption was too high.

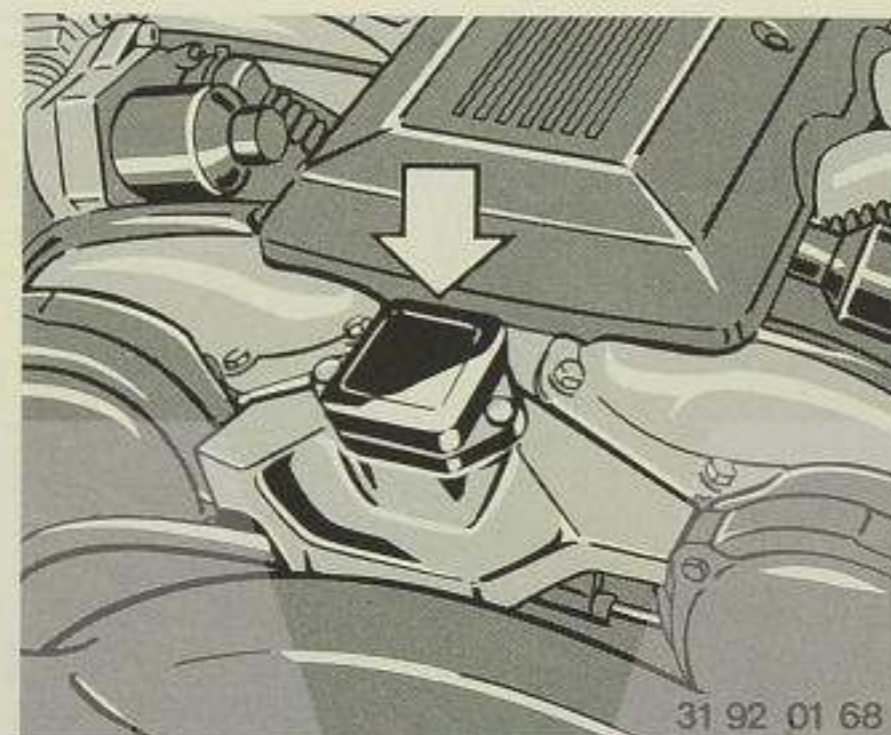

BMW 850Ci/BMW 850CSi

BMW engines are designed to operate without the car's owner having to use any separate additives in the oil, and indeed these substances could even be harmful in certain circumstances. The same applies to the manual gearbox or automatic transmission, the final drive and the power steering.

Engine oil specifications

The grades of engine oil to be used are exclusively governed by the CCMC or API specification.

Here are the required quality stages:

Preferred:	Also permitted
CCMC-G4 CCMC-G5*	API SG CCMC-G4/PD2 CCMC-G5/PD2*

* If engine oils to CCMC-G5 or CCMC-G5/PD2 specification are to be used, BMW Service should be consulted regarding their suitability for use all the year round.

When disposing of used oil, please comply with environmental protection laws.

Recommendation: Always have oil changes performed by the BMW service station.

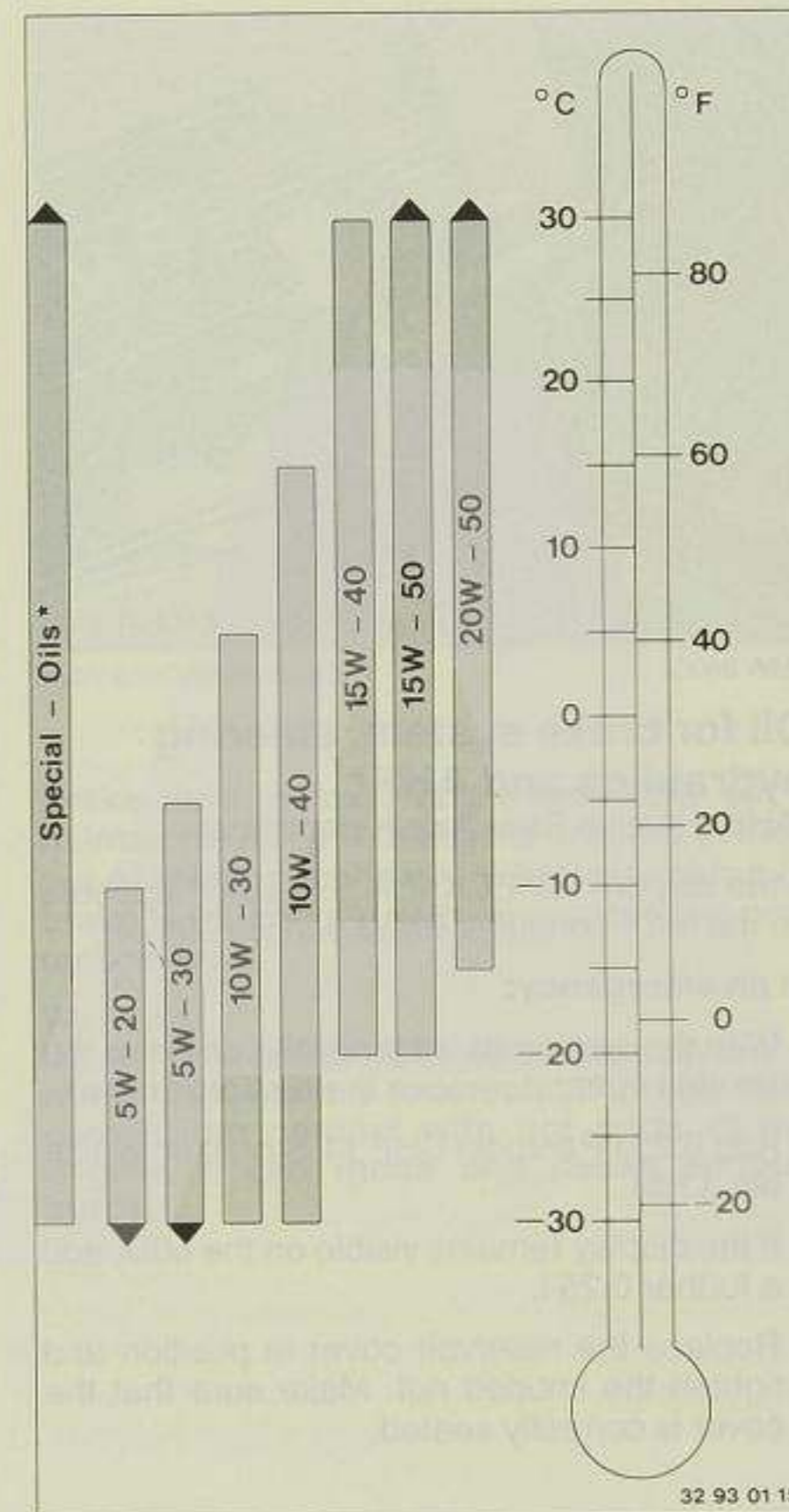

* Engine oils to CCMC-G5 or CCMC-G5/PD2 specification, individually approved by BMW

Viscosities

(The oil's liquid density, as shown by the SAE classification)

The choice of SAE grade depends on the average air temperature at the time of year.

The correct SAE grade is shown in the chart.

Note that the temperature limits indicated for the various SAE grades can be departed from for brief operating periods.

Warning:
In laboratory tests, prolonged contact with used oils has caused cancer.
For this reason, always wash the affected skin areas thoroughly with soap and water after work. Keep oils, greases etc. out of children's reach and in vessels marked with a suitable warning.



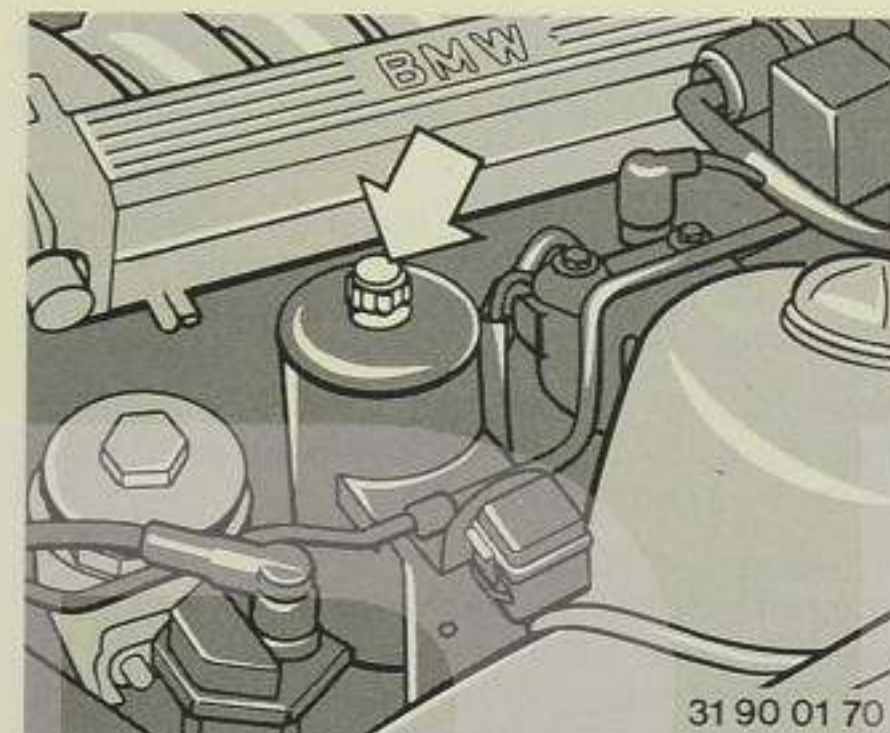

31 90 01 70

Oil for brake system and steering hydraulics

Checking oil level

- With the **engine stopped**, unscrew the knurled nut and take off the reservoir cover.
- Depress the brake pedal about 10 times until the oil level in the reservoir no longer rises and increased resistance is felt at the pedal.
- Check oil level: it must be about 20 mm below the rim of the reservoir.
- Correct the oil level if necessary. Top up only with Pentosin CHF 11 S – **never use brake fluid**.
- Replace the reservoir cover in position and tighten the knurled nut. Make sure that the cover is correctly seated.



31 93 01 124

BMW 840Ci

Oil for brake system, steering hydraulics and AHK*

(AHK = Active Rear Axle Kinematics)

If the display "CHECK P.A.S. FLUID" appears on the MID, consult a BMW service station.

In an emergency:

- With the **engine at a standstill**, unscrew the knurled nut and remove the reservoir cover.
- Add 0.25 l Pentosin CHF 11 S or, if unavailable, LHM.
- If the display remains visible on the MID, add a further 0.25 l.
- Replace the reservoir cover in position and tighten the knurled nut. Make sure that the cover is correctly seated.

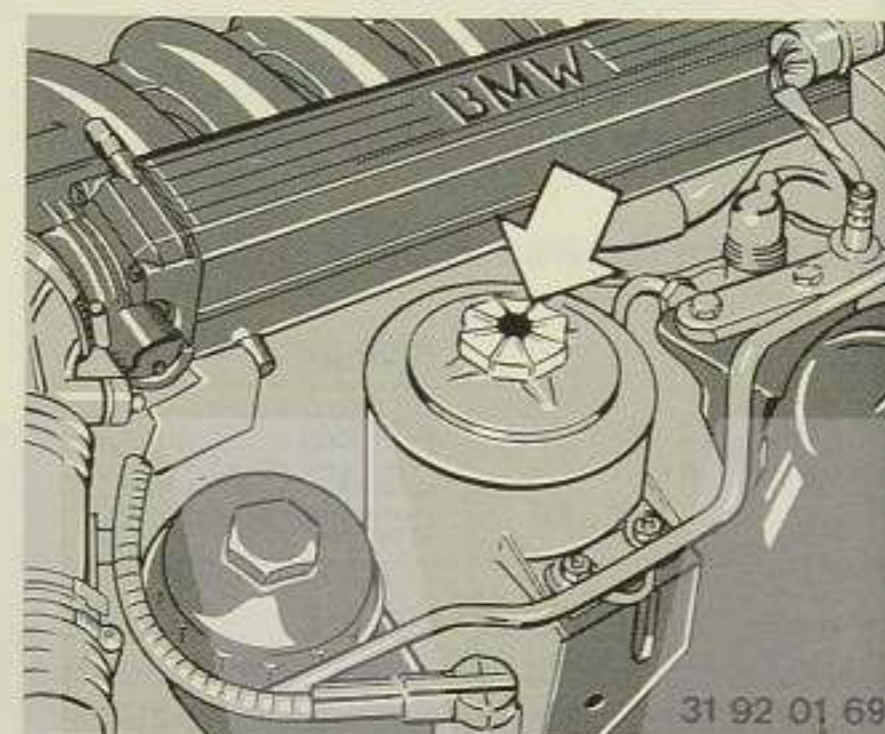

31 92 01 69

BMW 850Ci/BMW 850CSi



31 93 01 125

BMW 840Ci

Brake fluid

Fill to the upper (MAX) mark. The level can be seen from the outside. BMW service stations are familiar with the factory-approved brake fluids (DOT 4).

Warning:

Brake fluid is hygroscopic, that is to say it absorbs moisture gradually from the air. To ensure that the brake system remains fully operational, the brake fluid must be renewed every 2 years by a BMW service station.

Please comply in addition with the instructions given on Page 92 and Page 130.

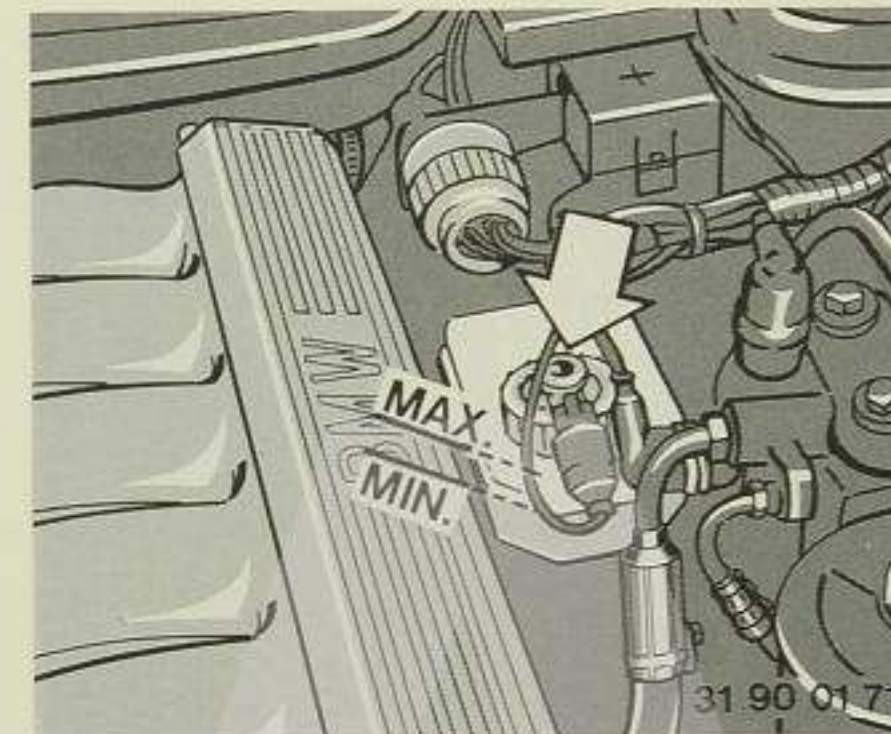

31 90 01 71

BMW 850Ci/BMW 850CSi

Brake fluid is toxic and attacks the car's paintwork. Keep it in sealed original packs, out of reach of children. When disposing of brake fluid, comply with environmental protection laws.

Warning:

Do not spill brake fluid. Add it only up to the MAX mark on the reservoir. If brake fluid comes into contact with hot parts of the engine, it can ignite and cause serious burns.



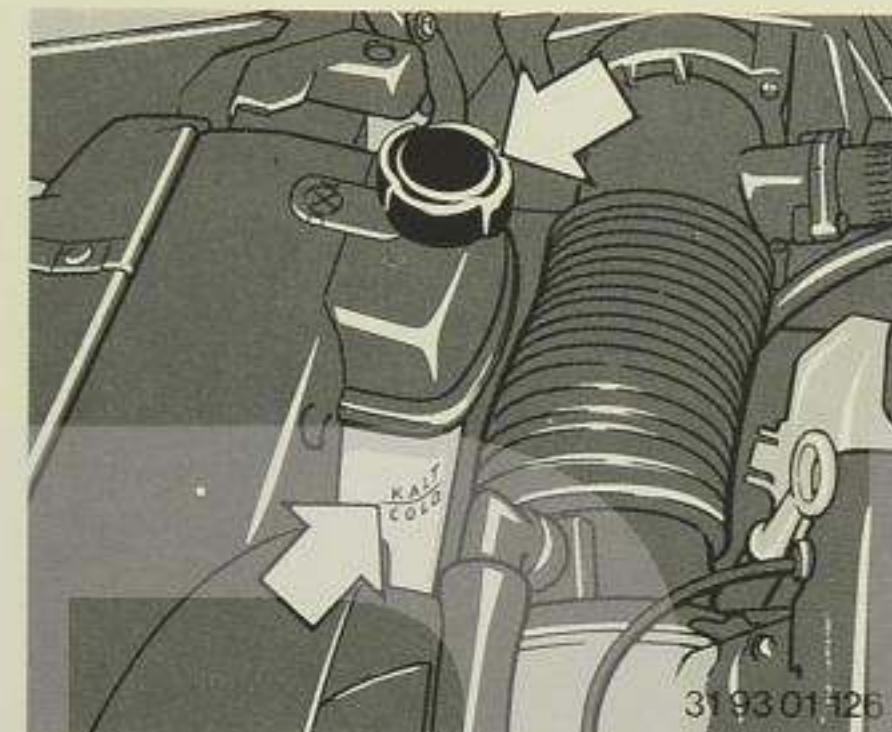

BMW 840Ci

Coolant

Coolant level with engine cold: up to the KALT/COLD mark on the translucent level equalizing tank.

The coolant consists of water to which a long-life antifreeze and corrosion inhibitor has been added. The 50:50 mixing ratio must be maintained all the year round to ensure protection against corrosion. No other additives are needed.

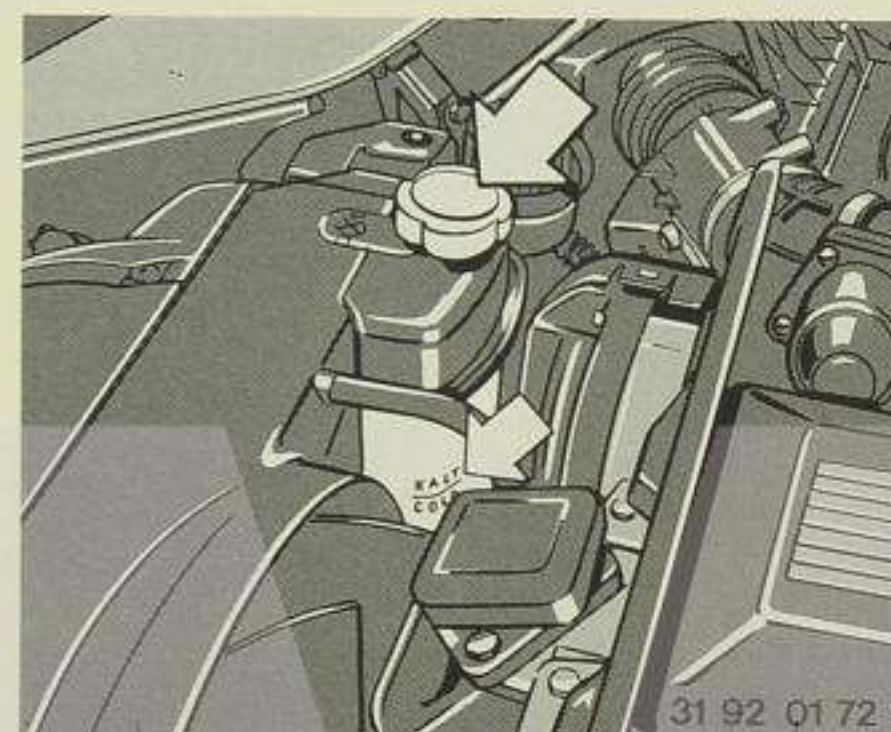

BMW 850Ci/BMW 850CSi

Renew the coolant every 2 years.

Adding coolant to system:

Open the cap on the equalizing tank **only when the engine has cooled down**. The pointer of the coolant thermometer on the instrument panel must be in the lower third of its scale, or else there will be a **risk of scalding**.

- Turn the cap anti-clockwise slightly until the excess pressure can escape, then remove it.
- Add coolant up to the KALT/COLD mark. If too much coolant is added, it will be lost through the overflow pipe.

Warning:

Never add coolant when the engine is hot. To avoid the risk of possible subsequent damage, use only factory-approved long-life antifreezes and corrosion inhibitors containing no nitrites or amino compounds. Every BMW service station is familiar with these products. Antifreezes and corrosion inhibitors are toxic. Store them only in the original packs, out of reach of children.

Warning:

Long-life antifreeze and corrosion inhibitor contains the flammable component ethylene glycol. Take care not to spill long-life antifreeze and corrosion inhibitor on hot parts of the engine, otherwise it can ignite and cause serious burns.

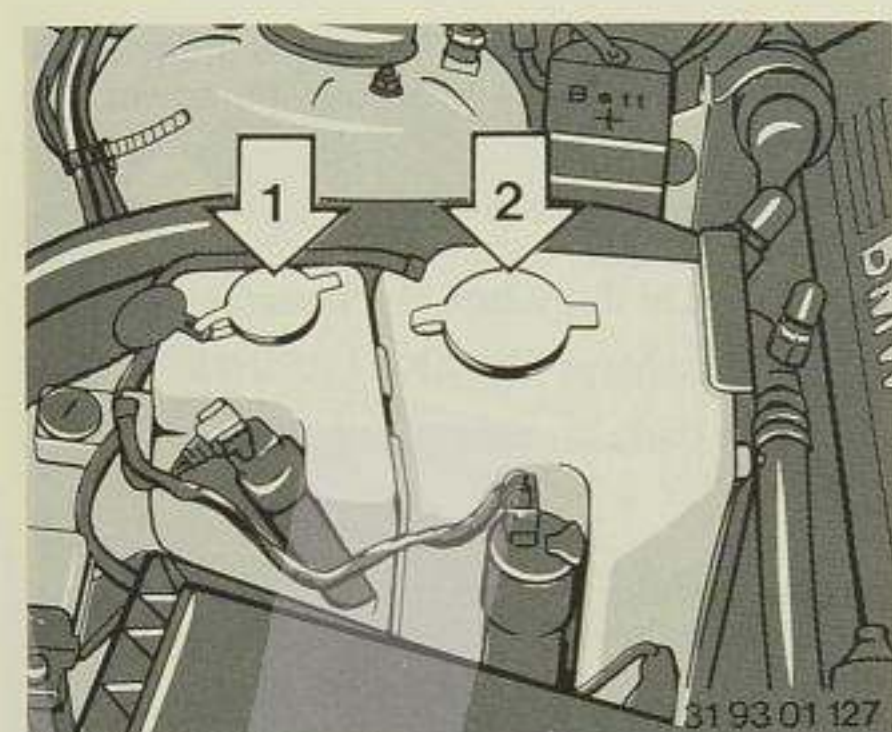

BMW 840Ci

Liquid for washer systems

Intensive cleaning system (1):

Capacity app. 1.0 litre (1.8 pints).

Fill with intensive cleanser (for frost protection down to app. -27°C, available from BMW dealers).

Windscreen washer (2):

Capacity app. 2.5 litres (4.4 pints).

Fill with water and add antifreeze if required (comply with manufacturer's instructions).

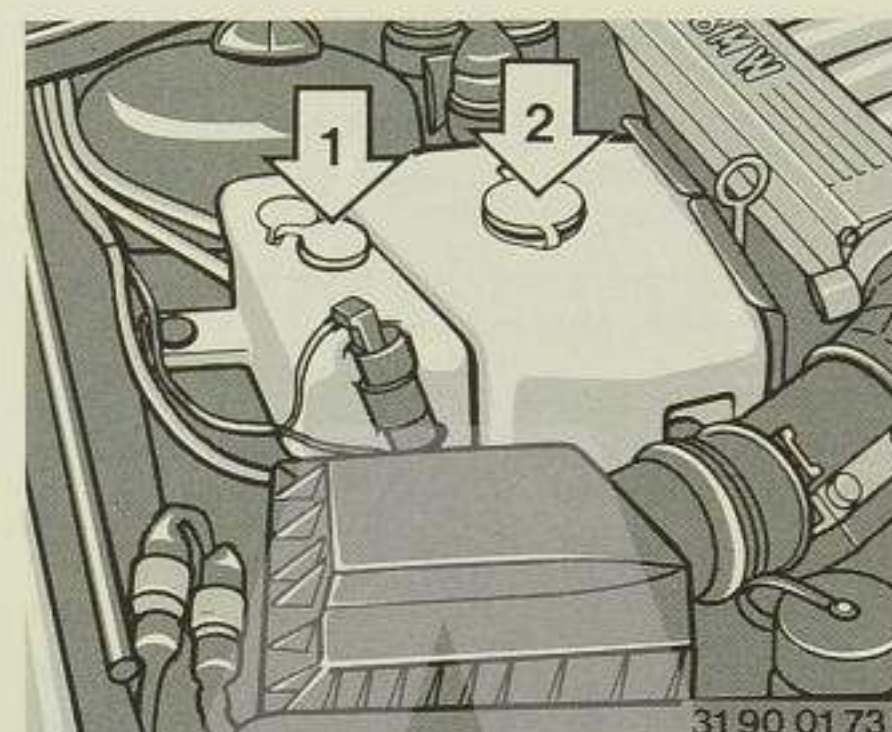

BMW 850Ci/BMW 850CSi

Combined windscreen and headlight cleaning system*

Add fluid at the filler pipe in the luggage compartment cutout (see next picture).

On vehicles with AHK (Active Rear Axle Kinematics) the front reservoir can also be filled at the front.

Capacity app. 9.0 litres (15.8 pints), or app. 6.0 l (10.5 pints) on vehicles with AHK.

Fill with water and add antifreeze if required (comply with the manufacturer's instructions).

Warning:

Only add cleaning agents and antifreeze after diluting with water, i.e. never in their concentrated form, to prevent causing any damage to the rear light.

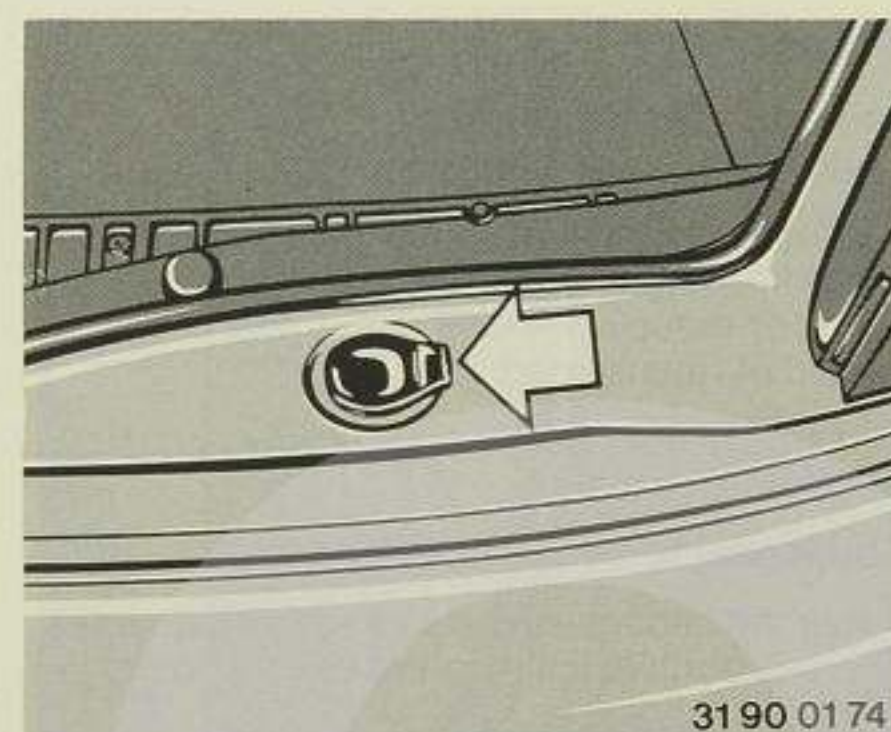

31 90 01 74

Note:

Do not operate washers when the reservoirs are empty.

Windscreen washer jets

The jets of liquid should strike the windscreen in such a way that reliable cleaning is assured even at high speeds.

Correct the jet position if necessary by inserting a suitable implement (e.g. a needle) and moving the jet as required.

Headlight cleaning system jets

Have these jets adjusted by a BMW service station if necessary.

Power steering

If the steering is stiff to turn:
Check oil level, see Page 86.

If steering is stiff when the steering wheel is moved rapidly:
Slack or defective V-belt. Have the V-belt renewed or retensioned.

If this does not effect a cure, always consult a BMW Service station.

Applicable to Servotronic only*

If steering becomes lighter as speed increases:
There is a malfunction in the electronic control system.

Warning:
If the power assistance should fail, greater effort will be required at the steering wheel.

Brake system

If the **warning light** for the brake and steering hydraulics **comes on** and "LOW BRAKE FLUID" is displayed on the MID:

Brake fluid has been lost from the system, causing pedal travel to increase.

Failure of one brake circuit

Brake pedal travel increases and higher pedal pressure is needed.

The car can still be braked effectively with the intact brake circuit.

However, you should take the car to a BMW service station without any delay if a brake system malfunction occurs.

If the warning light **flashes** and the MID displays "BRAKE ASSIST INACT.", the following faults may have occurred:

- If increased brake pedal pressure is needed: loss of reservoir pressure, no brake servo action.

- If the power steering becomes heavier to turn: loss of system pressure, no power assistance

- If brake pedal pressure is higher and the steering heavier to turn: the hydraulic pump has failed or the V-belt has broken.

If the MID displays "**BRAKE LININGS**":

The brake pads are worn. Have them renewed without delay.

Warning:
Use only brake pads approved by BMW, or else the car's operating permit will be invalidated.

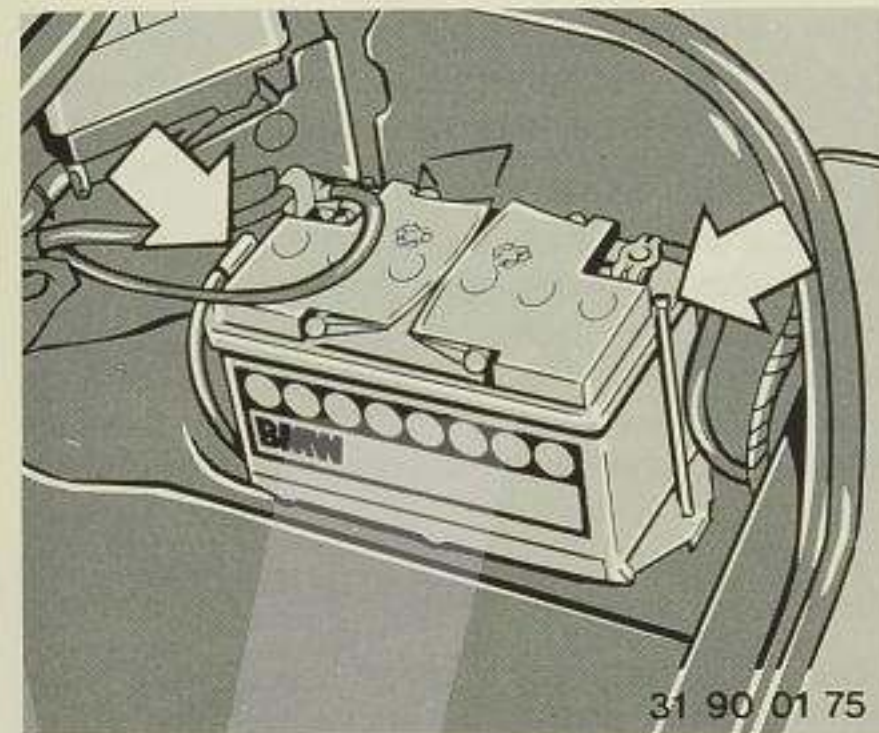

31 90 01 75

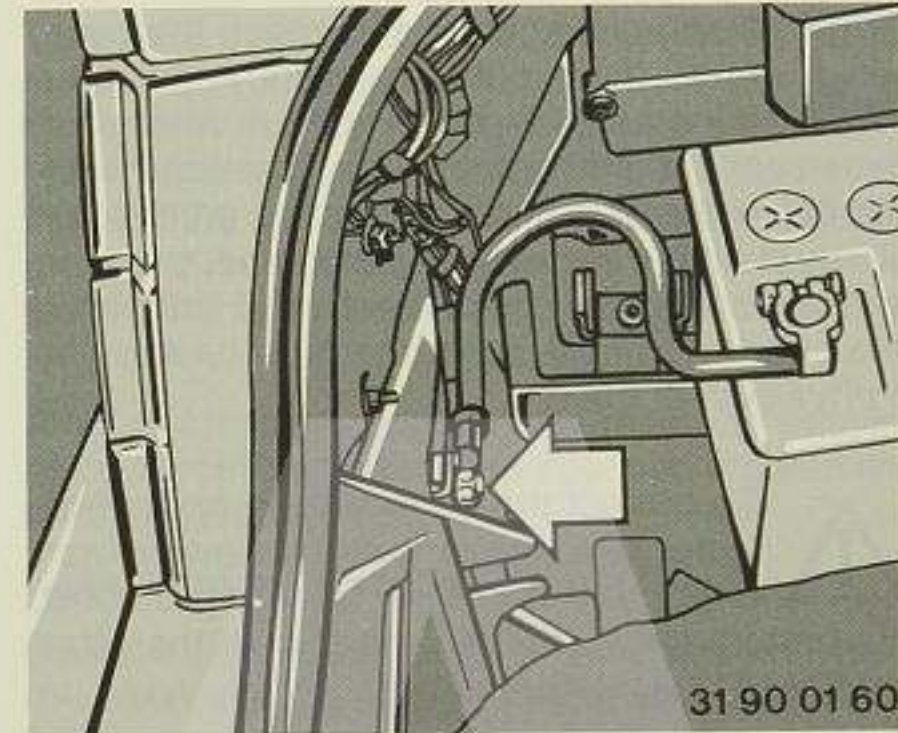

31 90 01 60

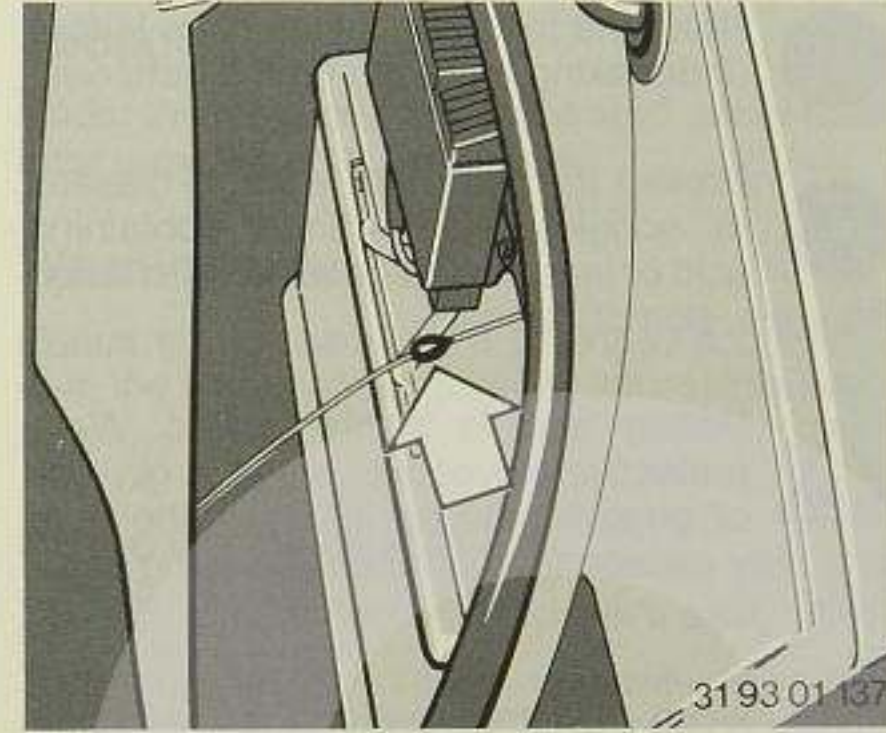

31 93 01 137



Batteries

The two batteries are located behind the side trim panels in the luggage compartment. There is a positive terminal in the engine compartment to which a jumper lead can be connected if necessary (see Page 96).

The batteries are maintenance-free to German DIN 43539/2 standard, that is to say their acid content normally lasts for the lifetime of the battery.

If the acid level drops too low, for instance if the car is used for lengthy periods in a hot climate, top up with distilled water (not acid).

Acid level: up to the "MAX" mark on the outside of the battery in each cell (app. 5 mm above the tops of the plates in the cells).

Keep the tops of the batteries clean and dry.

Warning:
Never disconnect one of the batteries only. Before removing, either detach the negative terminals at both batteries or their common earth (ground) strap at the body (see arrow).

Before detaching the right luggage compartment trim, first disconnect the plug connection for manual fuel filler flap release at the pull wire (arrow).



Read the following instructions before undertaking any work on the batteries:



Protect the eyes with suitable glasses or goggles. No particles containing acid or lead should be allowed to reach the eyes, skin or clothing.



Battery acid is highly caustic. Wear protective gloves and suitable glasses or goggles. Do not tilt the battery, or acid may escape through the degassing apertures.



Keep children away from acid and batteries.



Avoid fire, sparks or naked flames close to the battery. Do not smoke. Try to avoid sparks when using cables or from other electrical equipment. Avoid short-circuits, and never short-circuit the battery posts. The high-energy sparks which result could cause injury.



When batteries are charged, a highly-explosive gas mixture is emitted and can detonate.



If any splashes of acid reach the eyes, rinse them out immediately for some minutes with clean water. After this, the victim should be seen by a physician without delay. Neutralize acid splashes on the skin or on clothing immediately with soapy water, and rinse off with copious water. If the victim has swallowed acid, he or she must be seen by a physician at once.



To protect the battery case from ultraviolet rays, keep batteries away from direct daylight. In a discharged state, the battery could freeze, and should therefore be stored in a frostproof area.

Never disconnect the battery leads when the engine is running, or voltage peaks will damage the car's electronic systems beyond repair.

Disconnect first the negative terminal(s), then the positive terminal(s), and take off the degassing tank at the side. Unscrew the threaded battery retainer.

When installing, make sure that the batteries are held securely. Connect the positive terminals first, then the negative terminals.

Recharge batteries in the car only with the engine stopped. It is easiest to recharge both batteries by way of the positive terminal and earth (ground) point in the engine compartment. Starting with a flat battery: see Page 96.

To avoid short-circuits, disconnect both negative terminals from each battery or detach the common earth (ground) cable before starting any work on the electrical system.

If the car is to remain out of use for more than four weeks, disconnect the batteries from the car's electrical system by detaching the batteries' negative post clips.

If the car is to remain out of use for longer than six weeks, remove the batteries, recharge them and store them in a cool place (but protected against frost). Restore the battery charge at least every three months, or the batteries will be rendered useless. A battery's operating life is reduced each time it is discharged, especially over longer periods of time.

If one of the batteries is defective and has to be renewed, two new batteries of identical make and type must always be installed.



Hand old batteries back to an authorized collection point or a BMW service station. When filled, always carry or store batteries upright. During transport, secure the batteries so that they cannot tip over.

Warning: Periods of time in which the car's battery is disconnected are disregarded by the service interval indicator when calculating the need for brake fluid renewal. Take any such periods into account with regard to the two-yearly brake fluid renewal interval, and do not wait until the clock symbol lights up.

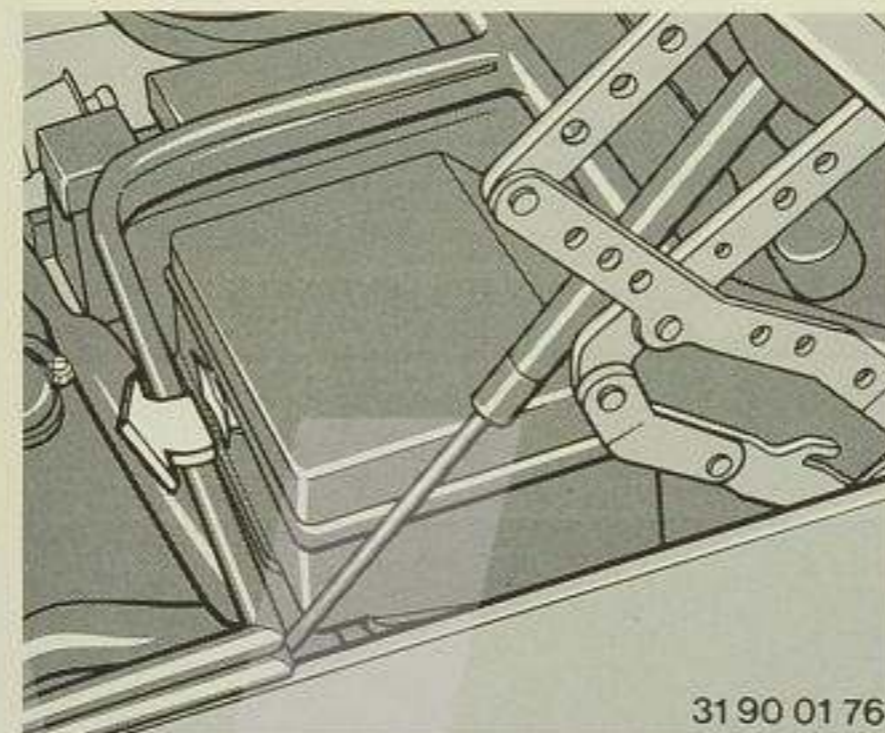

Fuses

If an electrical consumer fails, switch it off and check its fuse.

The **fuse box** (electrical distribution box), with spare fuses, relays and plastic pincers, is on the left inside the engine compartment.

- Press the retaining flap in and lift off the cover.
- Use the plastic pincers to remove the blown fuse from its holder.
- A blown fuse can be recognized by its melted metal wire. Replace it by a new fuse with the same rating in Amps.

There are more fuses behind the left trim panel in the luggage compartment. On cars with Check Control and a trailer tow hitch*, there are additional fuses for the trailer lights in the trailer module in the luggage compartment, behind the left side trim. The fuse for the permanently positive line is located next to the battery, in a separate fuse box.

A list of fuses with ratings in Amps and details of the electrical consumers supplied is given on each fuse box cover.

Never attempt to repair blown fuses.

If a fuse blows several times in succession, ask the BMW service station to trace and rectify the fault.

Toolkit

Under the luggage compartment lid, accessible after unscrewing the wing bolt.

Warning triangle*

Space is provided in the toolkit to accommodate the warning triangle in an accessible position.

Fire extinguisher*

There is a mounting on the driver's seat. To ensure full operational reliability, have the fire extinguisher examined by a service station authorized by the manufacturer every 2 years.

If these service stations are not listed on the extinguisher or in any documentation available to you, please consult a local trade directory or the "yellow pages" of the telephone service to obtain the address.



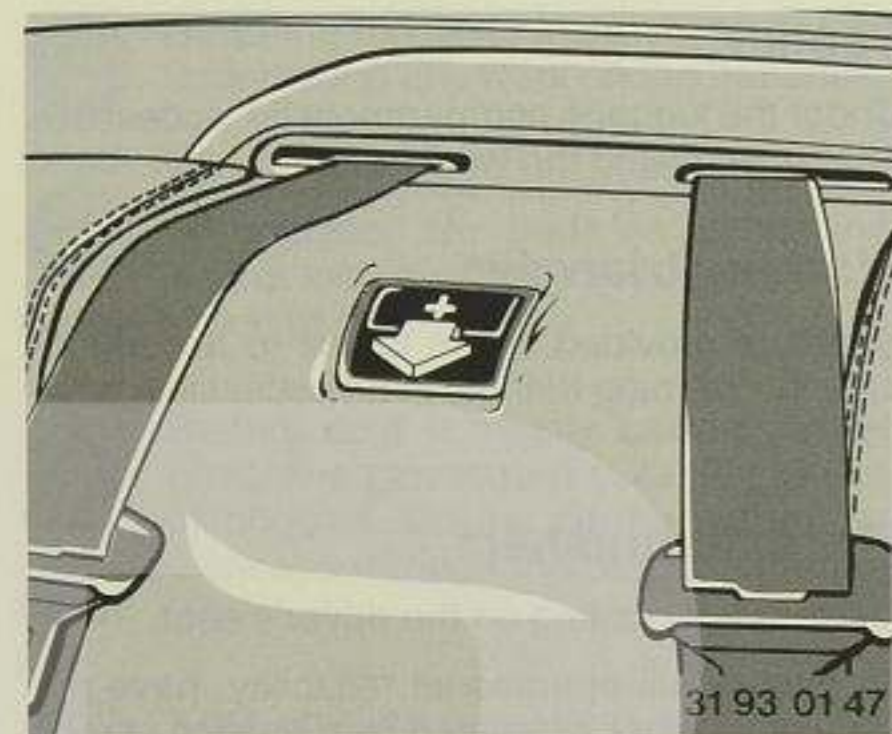

First-aid box*

Between the back seats. Pull the catch (arrow) down and swing the cover forwards.

Comply with legal requirements concerning the need to carry a first-aid kit in the car.

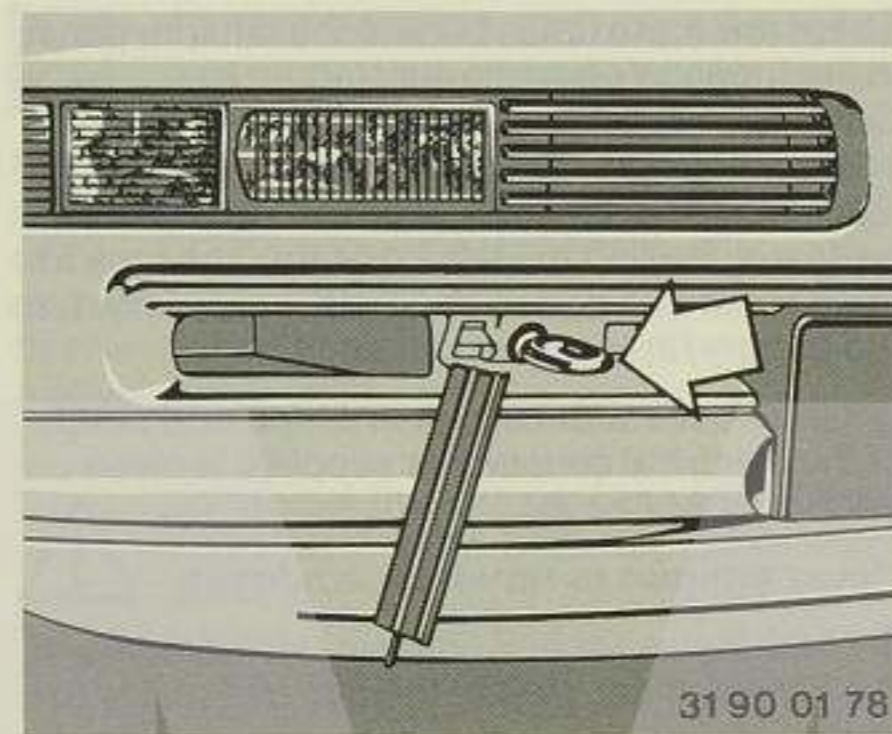

Towing eyes

The screw-in towing eye is kept in the toolkit and must always be carried. It can be attached at the front or rear of the car as required.

Warning:
Always screw the towing eye in fully.

Access to threaded hole for towing eye

Front:
Pull the left side of the cover out, and remove it.

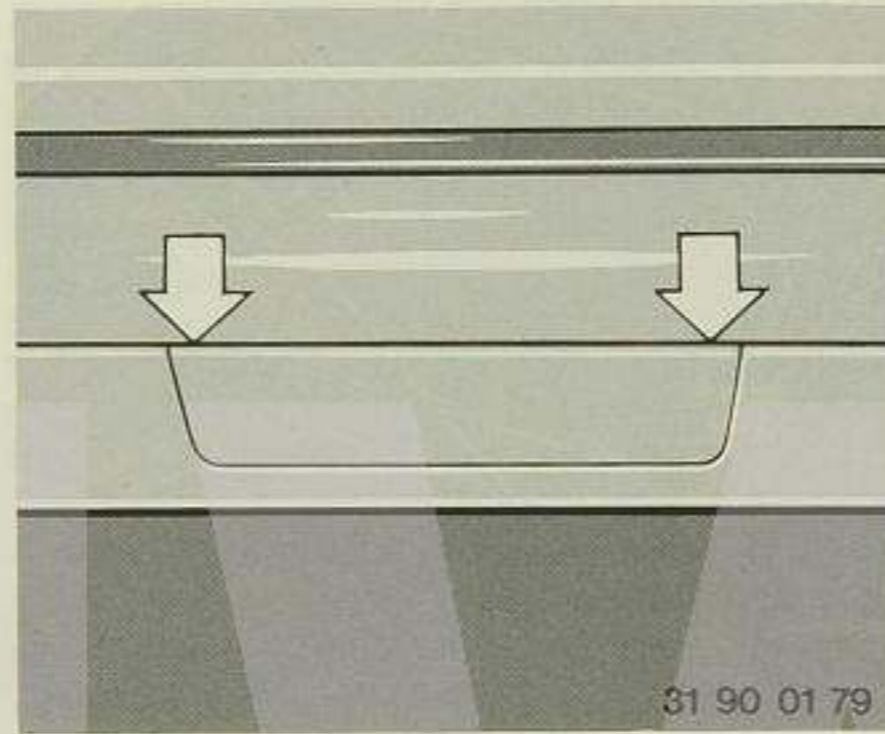

Rear:

Press the cover down at its left and right ends by inserting a screwdriver into the upper joint line (see arrows in picture).

On cars with a trailer tow hitch, the threaded hole is next to the ball head mounting.

To insert the cover, place it in the guide at the bottom and press in at the top.

For towing, either a rigid towbar or a nylon rope or tape should be used (the latter have the advantage of being resilient, so that severe loads are avoided).

Using a towbar:

The towing eyes of both vehicles should be on the same side.

If the towbar has to run at an angle, note the following:

- Clearance may be restricted when turning corners.
- The angled position of the towbar generates lateral forces (these may be critical on a slippery surface).
- To compensate for towbar angularity, the two vehicles cannot always be driven one directly behind the other.
- If the towing vehicle brakes, the other vehicle may overrun it or skid sideways.

Warning:

The towed vehicle should not be heavier than the towing vehicle.

Tow-starting

Cars with catalytic converter should only be tow-started if the engine is cold. The use of battery jumper leads is preferable.

- Switch on the hazard warning flashers. (Comply with national regulations regarding their use.)
- Turn the ignition key to position 2.
- Select third gear.
- Keep the clutch pedal down. When the car is moving, gradually release the clutch pedal. When the engine has fired and is running, depress the clutch pedal again.
- Switch off the hazard warning flashers when the car is clear of the road or no longer being towed.

Have the cause of the starting problem traced and rectified by a BMW service station.

Cars with automatic transmission

These cars cannot be tow-started.

For starting with a flat battery, see next page.

Towing away

- Turn the ignition key to position 1 so that the brake lights, turn indicators, horn and wipers can be operated.
- Switch on the hazard warning flashers. (Comply with national regulations regarding their use.)

If the car's electrical system has failed, display a warning notice to the rear or place the warning triangle in the rear window.

Cars with automatic transmission

- Move the selector lever to N.

Maximum towing speed: 50 km/h.

Maximum towing distance: 50 km.

Before towing the car for a greater distance, add an additional 1 litre of automatic transmission fluid (ATF) to the transmission or remove the propeller shaft.

Remember to reduce the transmission oil content again after the car has been repaired.

Warning:

When the engine is not running, there is no power assistance and the brake servo is out of action. The steering and brakes will require extra effort to operate.



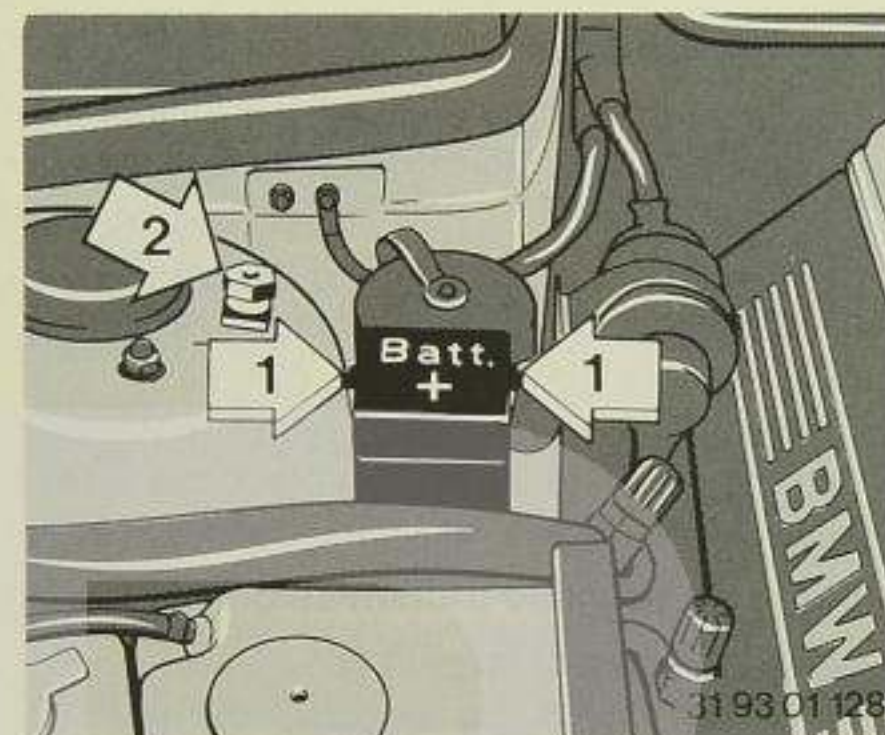

BMW 840Ci

Starting with a flat battery

Do not use spray products sold as an aid to starting.

If the car's own battery is flat, the engine can be started by using two jumper cables from another vehicle's battery.

Warning:
Touching any live components when the engine is running can result in a fatal electric shock.

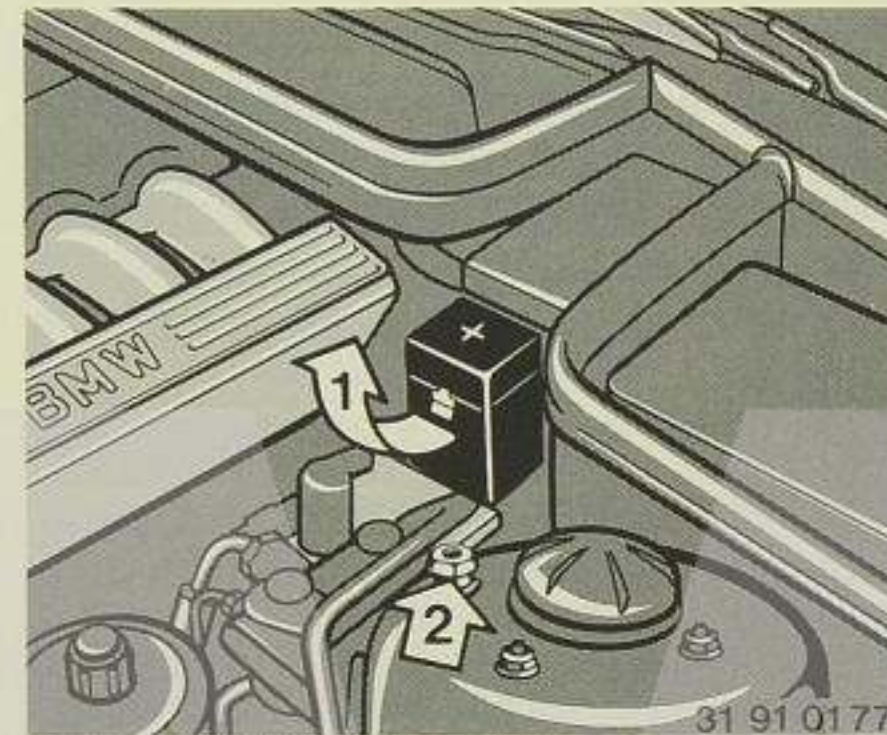

BMW 850Ci/BMW 850CSi

Do not depart from the procedure described below, or else personal injury could result, or one or both vehicles be damaged.

1. Check that the other vehicle has a 12 Volt battery with approximately the same capacity (65 Amp/h). This should be printed on the battery.
2. Do not disconnect the flat battery from the car's electrical system.
3. The bodies of the two vehicles must not touch, or a short circuit could result.
4. First connect the positive terminal of the other car's battery with one of the jumper leads to the positive pole in the BMW's en-

gine compartment (this has a protective cover marked "+" which can be removed by pulling the flap (BMW 850Ci, 850CSi) or by pulling the two flaps at the side (BMW 840Ci - see left picture, arrow 1).

Then connect up the batteries negative terminals. First attach the jumper lead to the negative terminal of the other vehicle's battery or to the other car's engine or body earth and then to the engine or body earth (nut on spring strut dome, see picture, arrow 2) of your own car.

Warning:

When connecting up jumper leads, also when assisting other vehicles, please keep to above order to prevent sparks forming at the battery.

5. If the second vehicle's battery is not well charged, run its engine. Start your own car's engine in the usual way and leave it running.
Before detaching the jumper leads from your BMW, switch on your car's lights, heated rear window and heater blower (at maximum speed) to ensure that the voltage reaching the consumers from the regulator is not too high. Then disconnect the jumper leads in the opposite order (negative pole first, then positive pole).

Have the battery recharged (depending on the cause of the fault).

Changing a wheel

Apply the handbrake and select either reverse or 1st gear (manual gearbox) or automatic transmission position P.

If you suffer a puncture during a journey, protect the car by switching on the hazard warning flashers and if necessary setting up the warning triangle or a flashing warning light at a sufficient distance to the rear.

Comply with national legislation in these respects.

To avoid rattling noises later, note how the various tools are attached to the car and replace them in precisely the same positions afterwards.

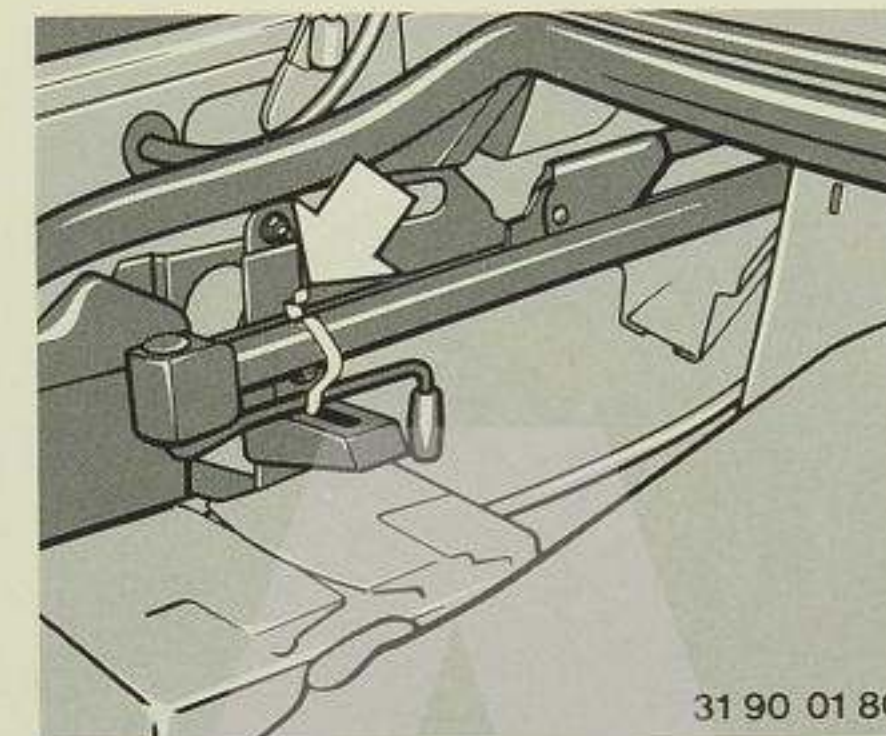

31 90 01 80

To change a wheel, you need:

Jack

In the luggage compartment, behind the left trim.

Pull the trim away at the pre-formed cutout. Release the spring clip (arrow) and take out the jack.

After use, lower the jack fully, place its base in the holder and press it forwards.

Spare wheel and hexagon adapter

These are both under the mat in the luggage compartment.

Take out the mat.

Take off the black hexagon adapter, unscrew the wing nut by hand and remove the wheel.

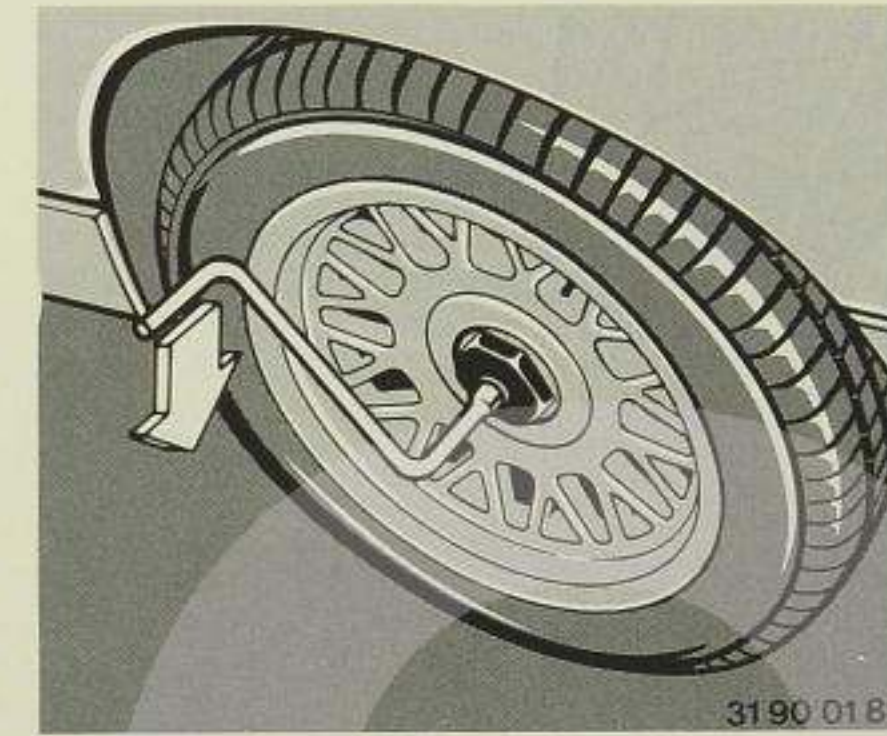

31 90 01 81

Wheel changing procedure:

1. Take off the wheel stud cover by applying the hexagon adapter and stud wrench to it and turning to the left.
For thiefproof wheel studs, see Page 100.
2. Slacken the wheel studs off by half a turn.
3. Press in and remove the jack attachment socket cover at the appropriate point on the car (arrow).
4. Insert the jack fully into the socket and position it so that the base is resting firmly on the road.
5. Raise the car's body with the jack until the wheel to be changed is clear of the road.



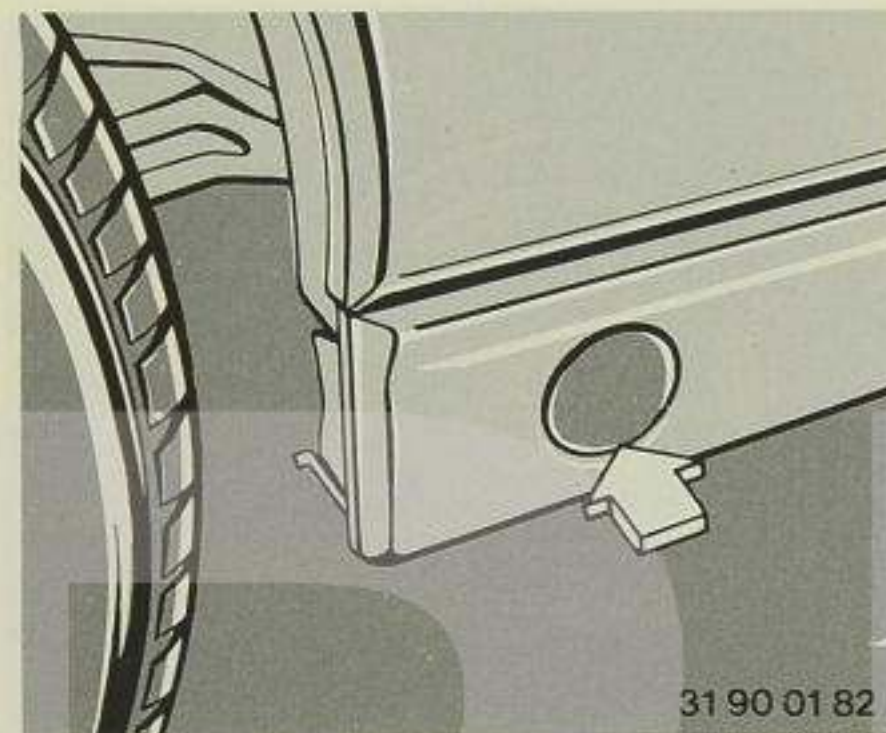

The wheel cover can only be fitted by a BMW service station or a specialist workshop.

Wheel stud wrench and centering pin

In the toolkit under the luggage compartment lid.

265/40 ZR 17* rear tyres

In the event of a puncture, it may be necessary to use the spare wheel with a 235/45 ZR 17 tyre at the rear. This wheel can be used without restrictions in all load and speed ranges. However, a tyre of size 265/40 ZR 17 should be fitted in place of the spare wheel as soon as possible.

Warning:

Use the jack only for wheel changing. Never attempt to lift another type of car or any other heavy object with it, as this could lead to accidents and personal injury.

Do not lie under a jacked-up car; a very severe or fatal injury could result.

6. Take out the wheel studs and remove the wheel.
7. Insert the centering pin from the car's toolkit into one of the threaded holes, with the plastic cap in position on it.
8. Offer up the new wheel, insert at least two of the studs at opposite points and take out the centering pin.

For light alloy wheels with turbine styling* or with a directional turbine-style cover,* please note:

These wheels or covers are asymmetric, and therefore intended to rotate in one direction only. The spare wheel matches the wheels on the right of the car; the spare wheel for the BMW 850CSi does not have a cover. The wheel illustrated is on the left of the car. If a puncture has occurred, the BMW 850Ci's spare wheel can also be fitted on the left of the car, but a wheel which rotates in the intended direction should be fitted instead as soon as possible.

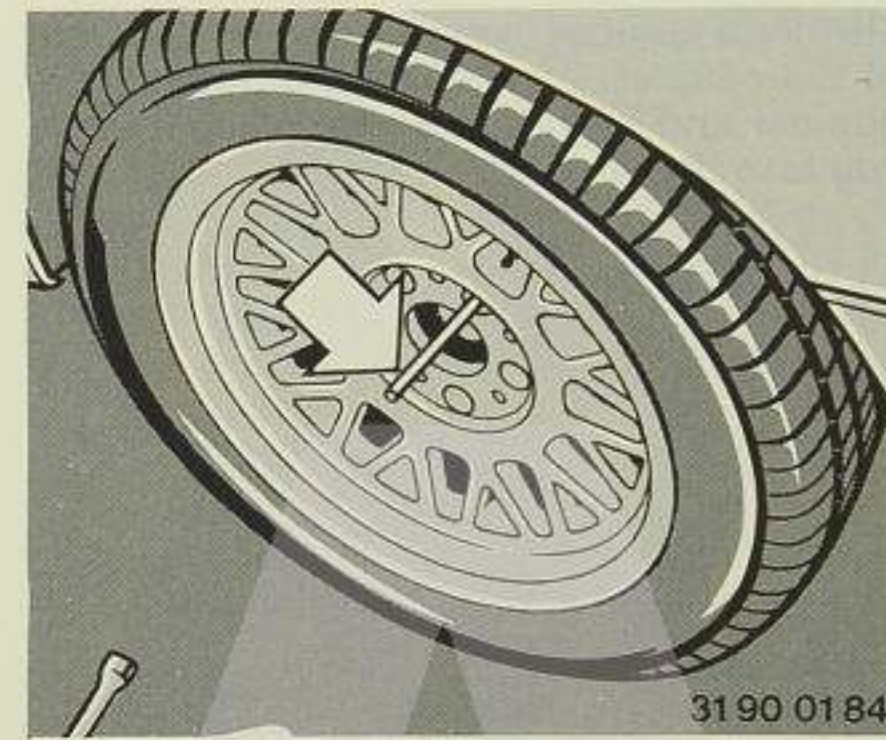
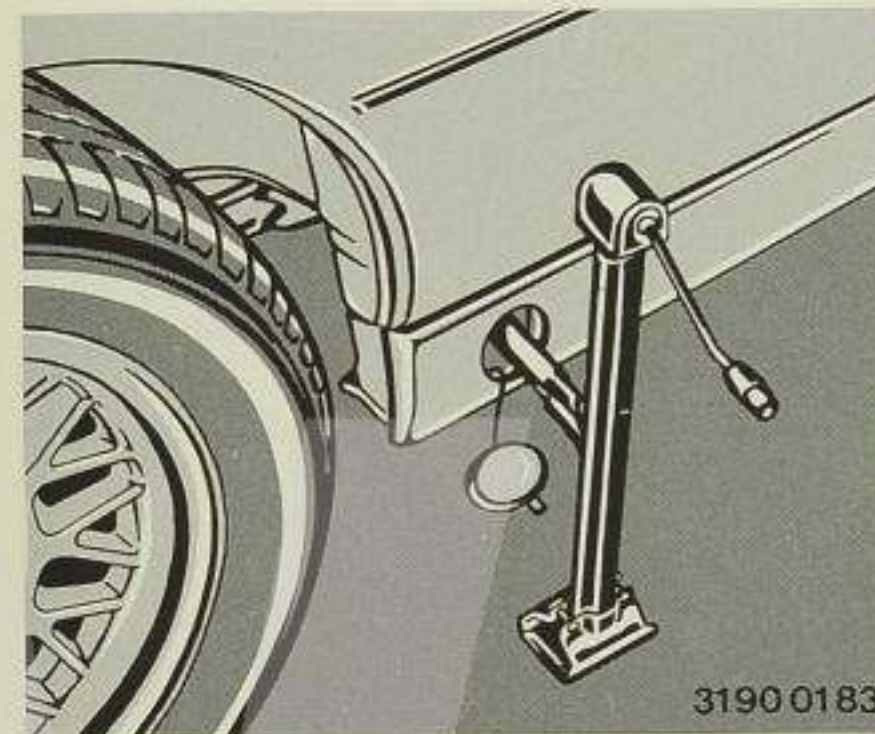

9. Screw in the remaining wheel studs and tighten them all in a crosswise pattern.
10. Lower the car, remove the jack, insert the jack attachment point cover with the flap at the bottom and press it in at the top.
11. Tighten the wheel studs fully, working in a crosswise pattern.

Warning:

For safety reasons, the wheel studs should be checked with a calibrated torque wrench without delay to ensure that the specified tightening torque of 110 Nm (81 lb.ft.) has been reached. If a new wheel (for instance the spare wheel) is fitted for the first time, check the tightening torque again after the car has covered 1000 km (about 600 miles).

12. Centre the wheel stud cover and attach. Push it on and turn to the left or right until wheel cap locks into place. Cross-spoke wheels* : align the arrow marked on the wheel stud cover with the line marked on the wheel and push on the wheel cover.

When replacing a wheel in the spare wheel well, make sure that the central threaded rod in the well is not bent or damaged.

If your car is equipped with wheels other than Original BMW light-alloy wheels, make sure that the correct wheel studs are used.

Have the flat or defective tyre repaired or replaced as soon as possible, and the new tyre balanced on the wheel.

Tyre repairs should only be entrusted to a BMW service station or an authorized tyre dealer with the specialized training needed to identify the full extent of possible tyre damage.

Important:

When tubeless tyres are removed and fitted or renewed, a new rubber-pattern valve should always be used as a safety precaution.



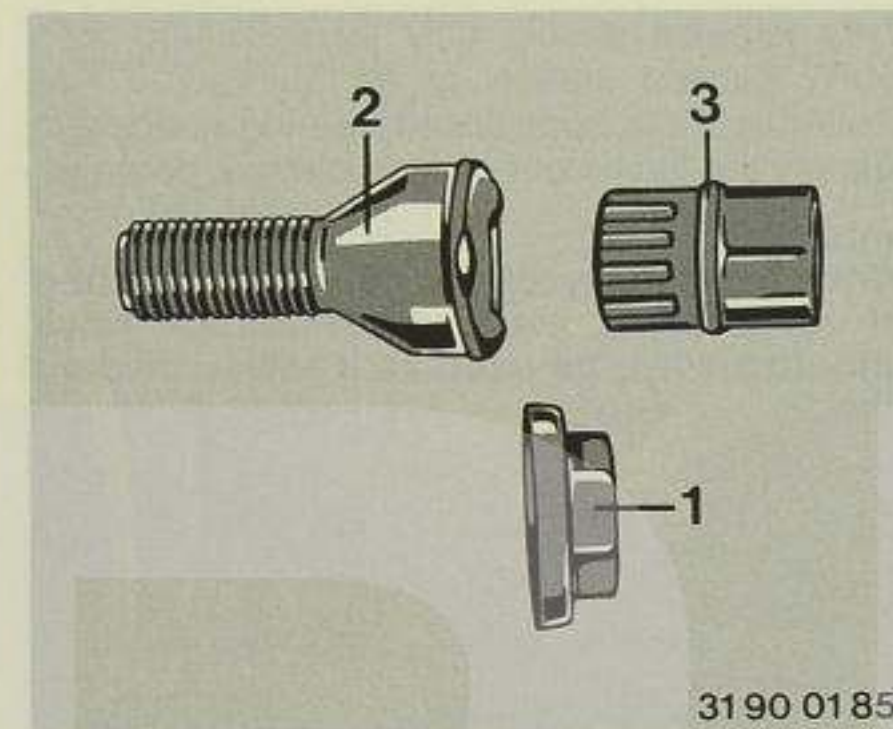

The code number is embossed on the front of the adapter. Please make a note of this number and keep it in a safe place in case you lose the adapter.

Thiefproof wheel studs

- 1 Cap (not if wheels have a wheel stud cover)
- 2 Wheel stud for adapter
- 3 Adapter (supplied in toolkit)

To remove:

- Turn the cap (1) slightly to the left with the wheel stud wrench and remove it.
- Take adapter (3) from the car's toolkit and insert it into the wheel stud.
- Unscrew the wheel stud (2).

After inserting and tightening the wheel stud again, remove the adapter and press on the cap.

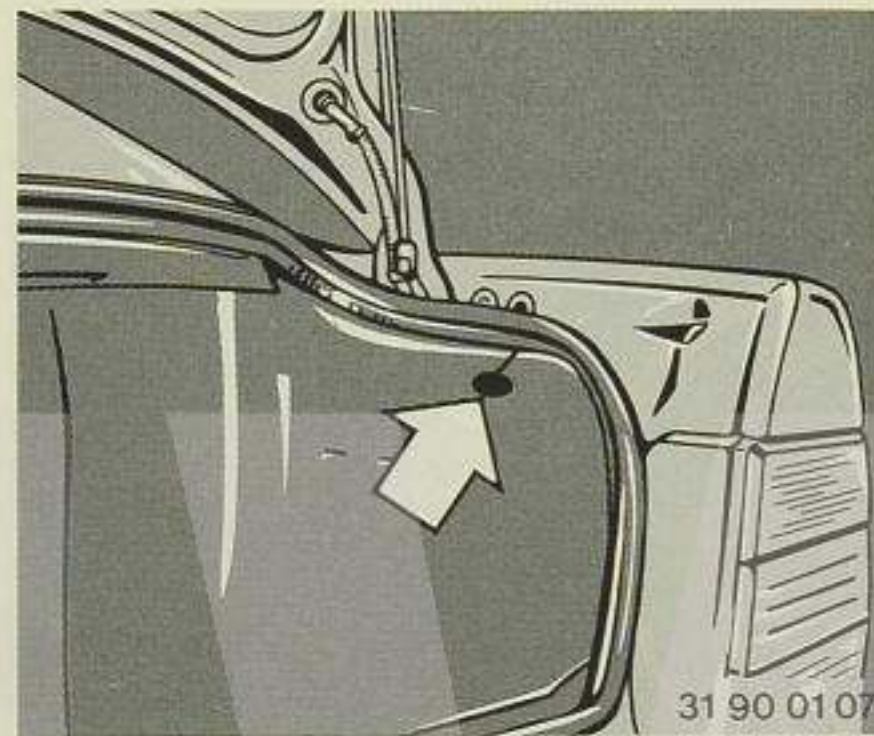

Manual operation of equipment after electrical failure

Releasing the fuel filler flap

Take the pull wire (arrow) out of the luggage compartment trim and pull it to the rear.

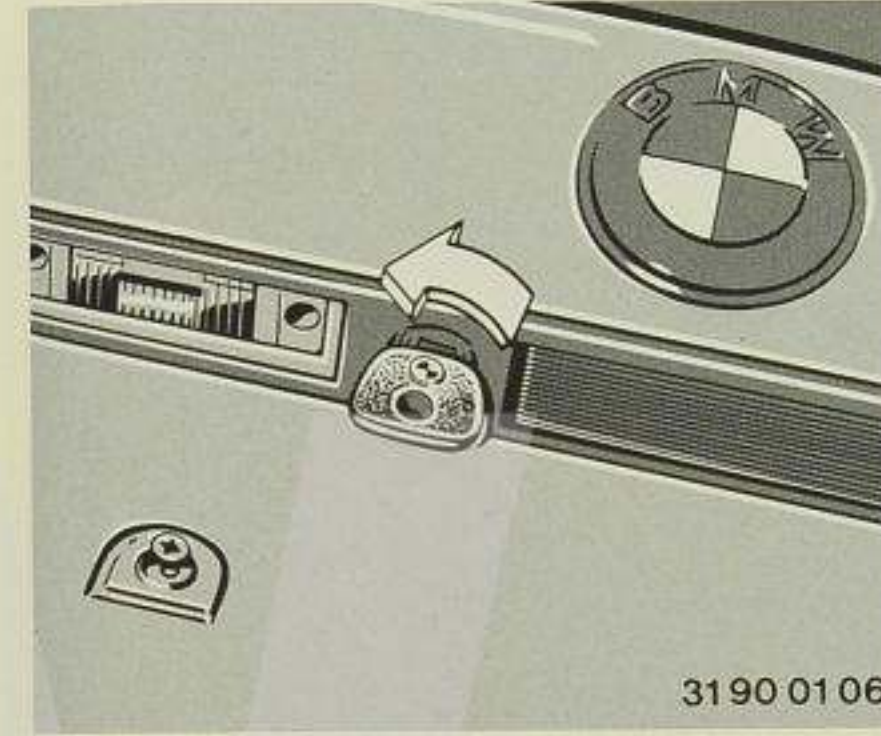

Luggage compartment

- Insert the **master key** from below into the lock next to the release button.
- Turn the key and remove it again in the position in which it was inserted.
- Press the lock barrel in.

The luggage compartment locks again as soon as it is closed.

Note:

If the thiefproofing system has been activated, the alarm will be triggered off if the luggage compartment is opened manually.



Sunroof

- Press out the interior light by inserting a screwdriver into the cutout.
- Take off the cover.
- Use the Allen key from the car's toolkit to move the roof in the desired direction.

To ensure that the sunroof operates correctly after repair or restoration of the power supply, it must be re-synchronized:

- Press the electric operating switch or keep it slid forwards for 12 seconds. (Do this only when synchronizing is necessary, not at any other time.)

Have the fault rectified by a BMW service station without delay.



Pop-up headlights

- Open the engine compartment.
- Turn the knurled knob to the left or right until the headlight unit is fully extended or retracted (and no longer moves when the knurled knob is turned several times).

Have the fault rectified by a BMW service station without delay.



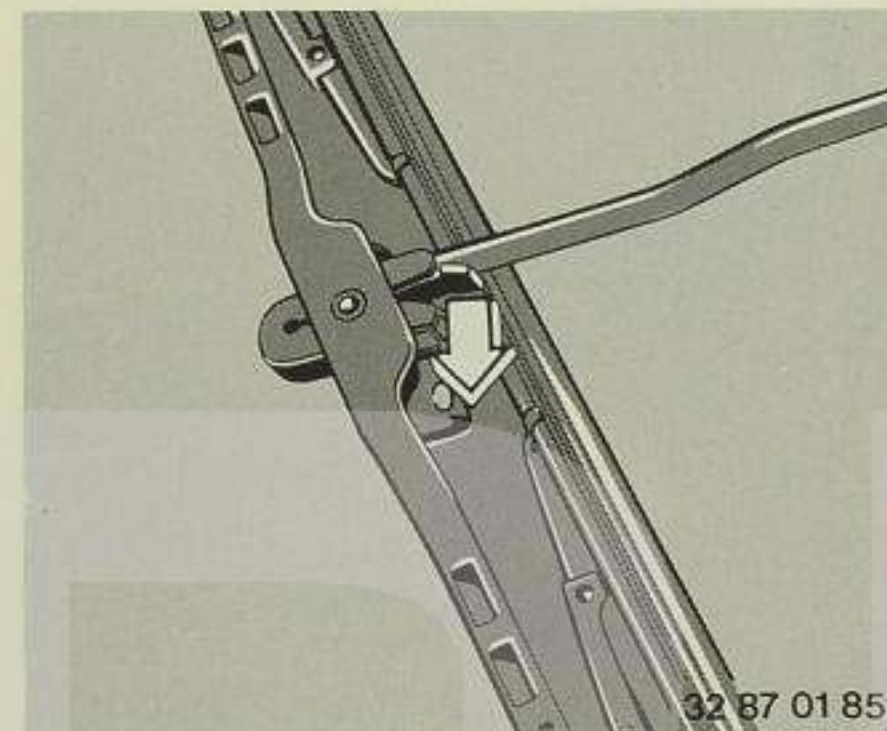

32 87 01 85

Renewing wiper blades

- Move the wipers to the fold-out position: Switch on the ignition. Move the wiper control lever to position 1 (intermittent wipe). Switch the ignition off again between wiper movements. The wipers will then move up to an almost vertical position.
 - Lift the wiper arm away from the glass and hold it securely.
 - For the driver's side wiper, pull the outer spring keeper first and then the inner one (arrow) until the wiper blade is released. There is only one spring keeper on the passenger's side wiper.
 - Pull the wiper blade towards the wiper arm.
- When inserting a new wiper blade, make sure that it engages securely.

Bulb changing

To avoid short circuits whenever working on the electrical system, switch off the affected consumers or disconnect the common earth (ground) strap between the batteries and the body.

Before attempting any work with which you are not thoroughly familiar, it is better to entrust it to a BMW service station.

Do not touch the glass of new bulbs with bare fingers. Use a clean cloth, paper tissue or similar instead, or handle the bulb only by its base.

A box containing spare bulbs is available from your BMW service station.

Pop-up headlights

Outer: Low beams

Centre: Fog lights

Inner: High beams

Each has one H 1, 55 Watt bulb.

Take off the painted upper section of the pop-up headlight:

- Rotate the toggle fastener through a quarter of a turn and lift the upper section slightly.
- Push the upper section forward and take it off.

Important:

When attaching the painted upper section of the pop-up headlight, make sure that it is seated correctly, particularly at the front mountings, and that the toggle fastener is properly closed by rotating through a quarter of a turn.

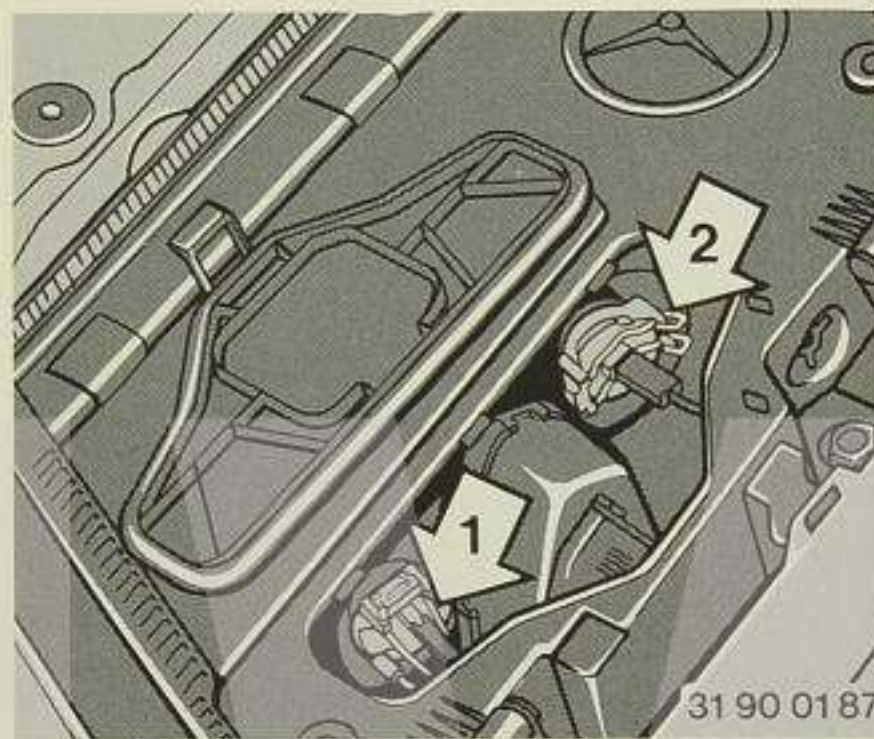

31 90 01 87

Low-beam headlight (1) and fog light (2)

- Pull the flap and take off the cover.
- Pull off the plug.
- Release the spring wire clip.
- Take out the old bulb and insert the new one.

When attaching the cover again, press it on uniformly all round.

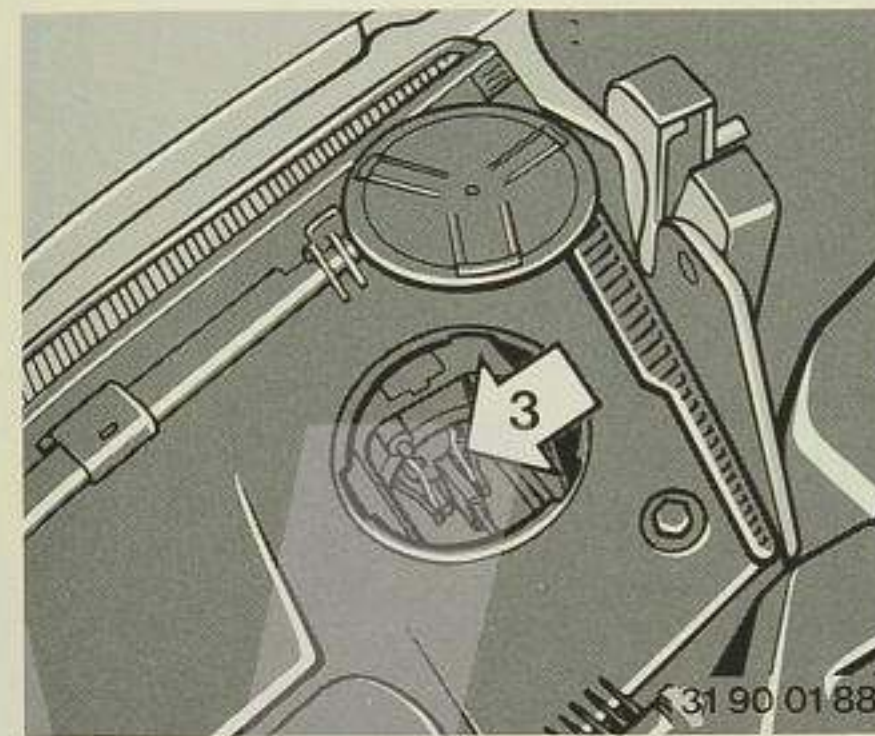

31 90 01 88

High beam headlight (3)

- Turn the cover to the left and take it off (bayonet catch).
- Pull off the plug.
- Press the spring wire clip in and disconnect it.
- Change the bulb.

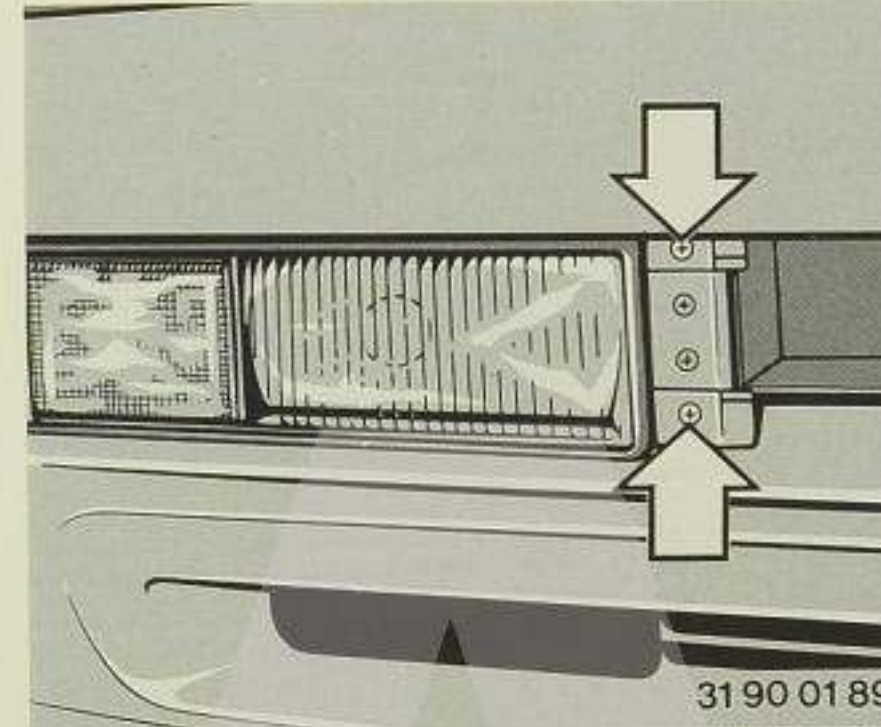

31 90 01 89

Lighting strip

Inner: High beams/headlight flasher
H 1, 55 Watt bulb

Centre: Side and parking light/daytime driving light*
21/5 Watt bulb

Outer: Flashing turn indicator
21 Watt bulb

Removing:

- Pull the grille out forwards.
- Take out the two Phillips-head screws (arrows).
- Pull the lighting strip out forwards, pivoting it slightly towards the outside of the car and removing it from the guide.

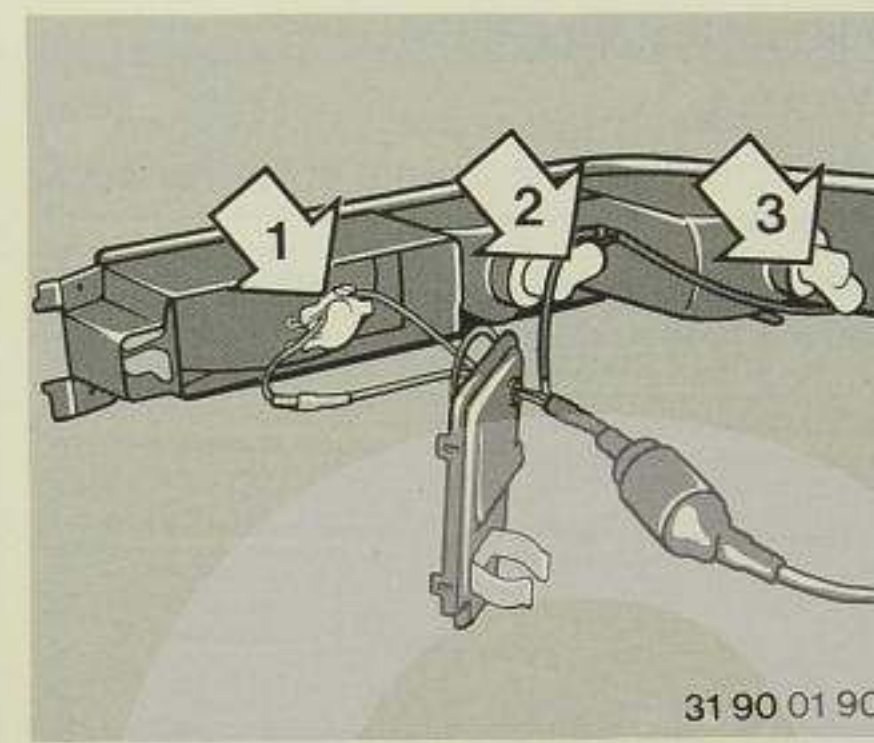

31 90 01 90

High beam/headlight flasher (1)

- Press the cover away from its fastenings with a screwdriver.
- Disconnect the cable.
- Release the spring wire clip and change the bulb.

Side and parking light/daytime driving light* (2)

- Turn the bulb holder to the left and remove it.
- Press the bulb in slightly and turn it to the left to remove.

Flashing turn indicator (3)

- Press the bulb holder in slightly and turn it to the right to remove.
- Take the bulb out in the same way.



Side turn indicator repeater*

5 Watt bulb

- Press the light unit forward at its rear edge, and remove it to the side.
- Press the bulb in slightly, turn it to the left and take it out.

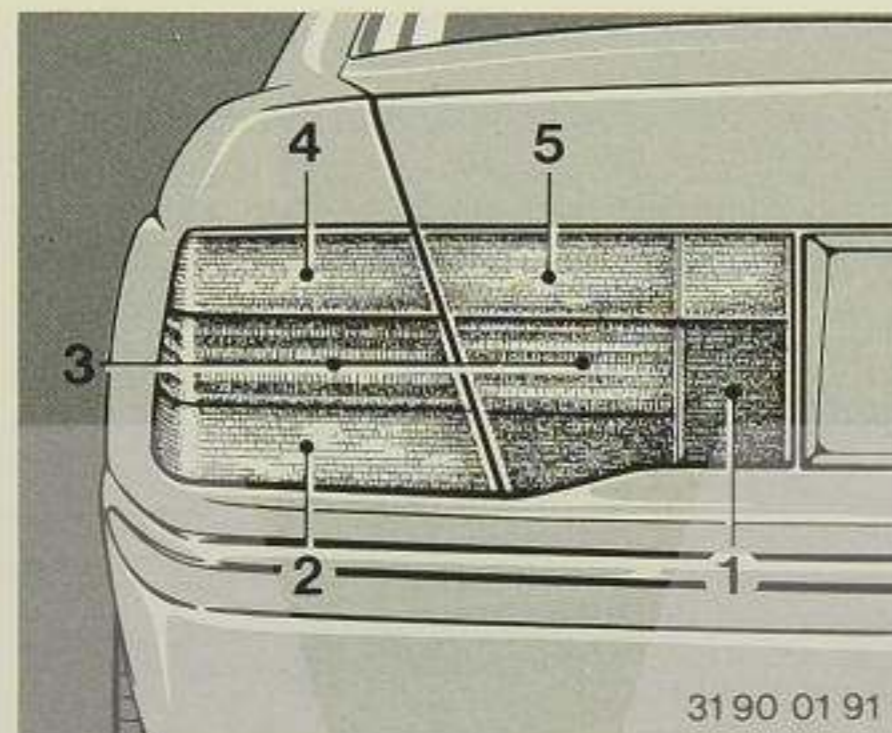

Rear lights

- | | |
|------------------------------|--------|
| 1 Rear fog light | red |
| 2 Brake light | red |
| 3 Rear lights and reflectors | red |
| 4 Turn indicator | yellow |
| 5 Reversing light | white |

Rear lights: two 5 Watt bulbs
Other lights: 21 Watt

Lights at side:

- Take off the trim by holding the pre-formed grip area and pulling.
- Press the appropriate bulb holder in slightly and turn it to the left to remove.
- Take the bulb out in the same way.

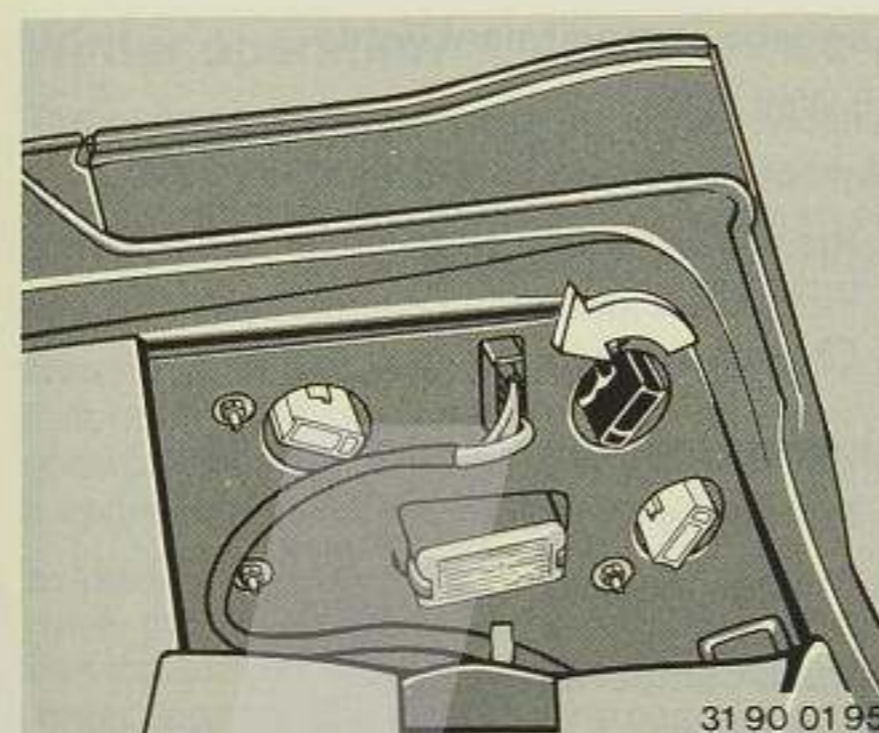

Lights in luggage compartment lid:

- Raise the trim (quick-release fasteners).
- Press the appropriate bulb holder in slightly, turn to the left and remove.
- Remove the bulb in the same way.

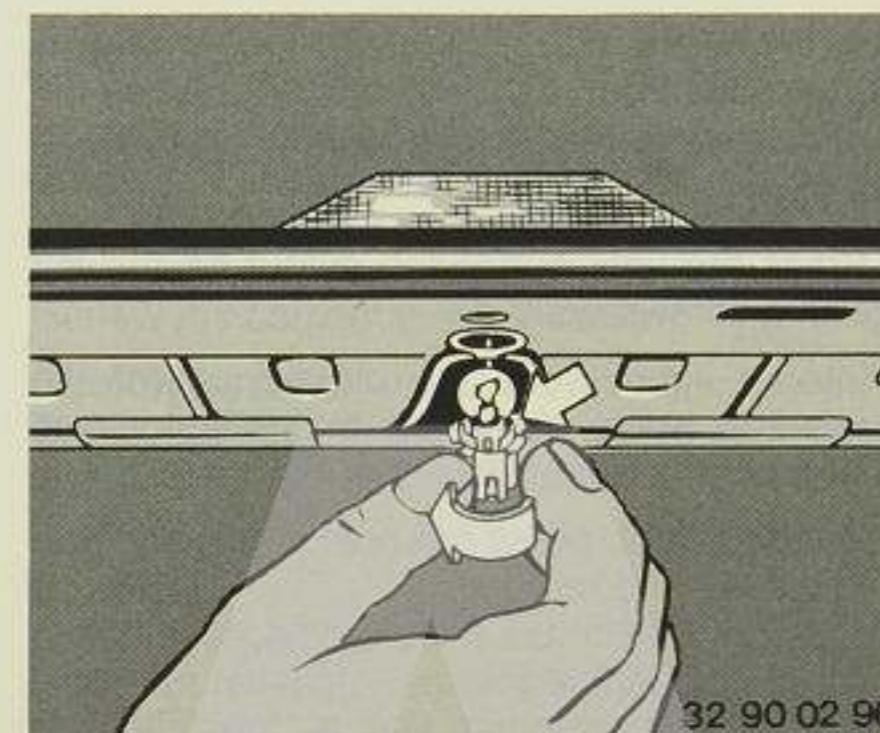

Central brake light*

21 Watt bulb

- Open the luggage compartment lid.
- Press the bulb holder in slightly, turn to the left and remove.
- Take out the bulb in the same way.

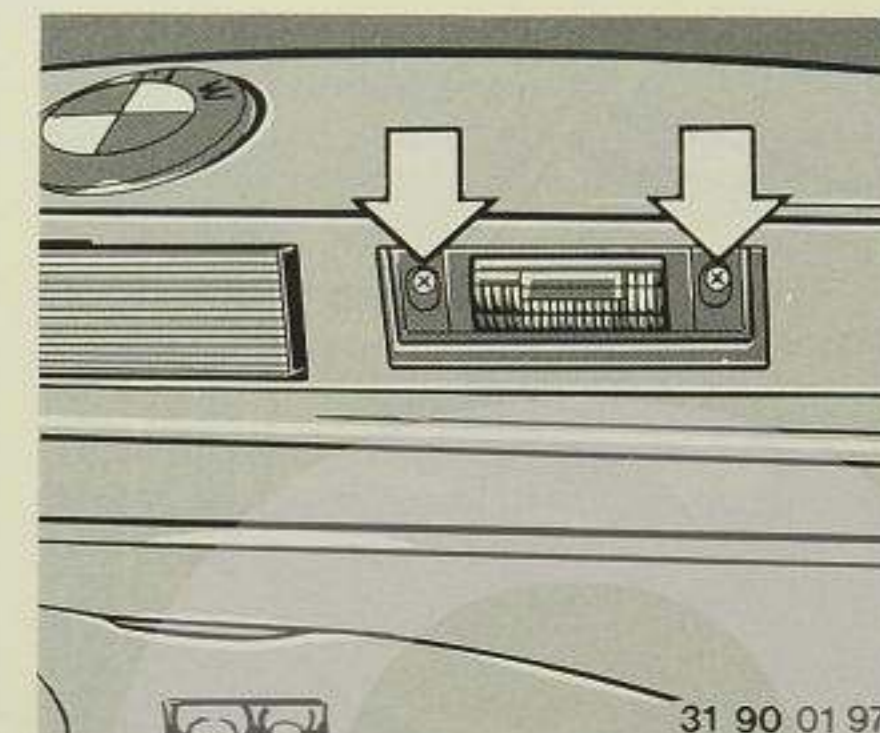

Licence plate lights

5 Watt bulb

- Remove the Phillips-head screws.
- Take off the glass surround with rubber seal.
- Pull the bulb out of the contact tongues.

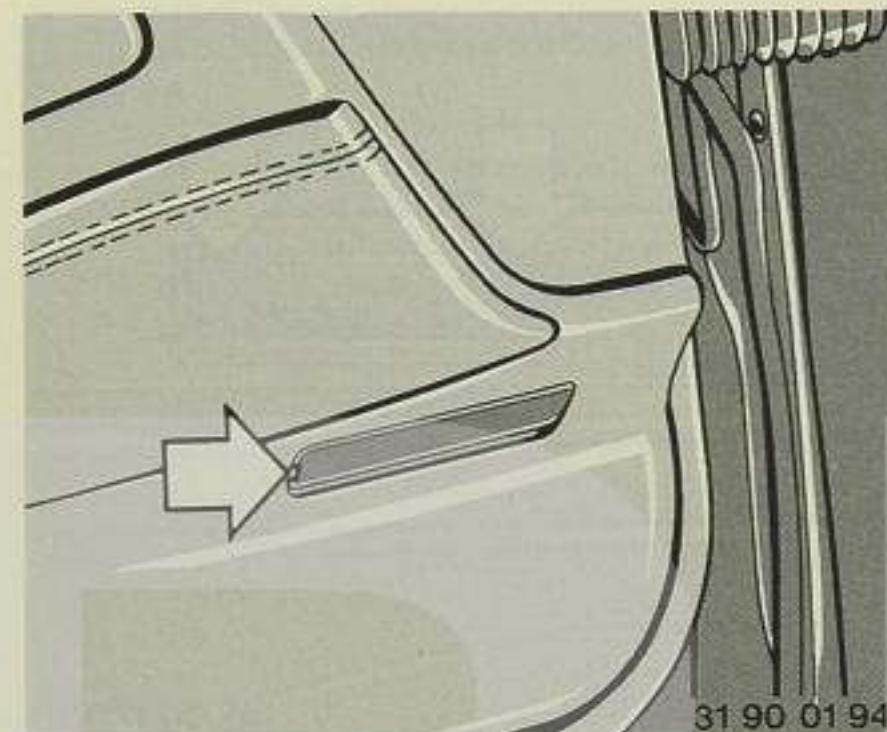

**Footwell lights**

5 Watt bulb

- Lever the glass carefully out with a screwdriver (arrow).
- Pull the bulb out of the contact tongues.

Interior lights**Front:**

Interior light (10 Watt bulb) with reading lights (10 Watt bulbs).

- Press the light out at the cutout on the left with a screwdriver.
- Interior light: press the plastic lug for the reflector back, swing up the reflector and take out the bulb.
- Reading light: press the bulb in slightly, turn to the left and remove.

Rear:

10 Watt bulb

- Press the light out at the side recess with a screwdriver.
- Swing up the reflector and take out the bulb.

Luggage compartment lights

10 Watt bulbs

Light on underside of rear-window shelf:

- Press it out with a screwdriver at the recess provided.
- Change the bulb.

Lights in luggage compartment lid:

- Pull off the glass.
- Change the bulb.

Engine compartment light

10 Watt bulb

- Press the black lug on the glass towards the centre with a screwdriver and take off the glass.
- Take out the bulb.

Glove box light

5 Watt bulb

- Press the light out of the lower glove box by applying a screwdriver to its outer edge.
- Change the bulb.

Winter operation

The changeable weather in the winter months calls not only for a suitably cautious style of driving but for certain measures to be taken on the car to ensure that it can be driven safely and without problems throughout the winter.

Measures to be taken on car

Before the cold season of the year sets in, it is good practice to have the BMW Service station prepare the car for the winter.

Brakes

Have the brake system checked by a BMW Service station regularly before and after the winter season. The work can be combined with routine maintenance.

Engine oil

Comply with the relevant instructions (see Page 86); if possible, have an oil change carried out before the cold season starts.

Oil level check

At manual gearbox or automatic transmission, final drive, power steering and brake system hydraulics.

Coolant

Make sure that the mix ratio of 50:50 (water to long-life antifreeze with corrosion inhibitor) is present. It should remain in the system all the year round, and provides protection down to a temperature of app. -37°C . Renew the coolant every 2 years.

Cooling system

Check the cooling system for leaks and renew any coolant hoses which have become brittle or porous.

Batteries

A well-charged battery is essential if the engine is to start reliably. Remember that batteries are less efficient at low temperatures, in other words precisely when the load on them increases.

Locks

Use only factory-approved care products* to ensure reliable operation. They will also prevent the locks from freezing. If a lock freezes despite this precaution or as the result of a malfunction in the lock heating, it can be thawed out with a heated key blade.

Do not use de-icer, as it has a degreasing effect and will impair the functioning of the locks.

Rubber seals on doors and engine and luggage compartment lids

To prevent the seals from freezing together, treat rubber surfaces with a rubber care product* or silicone spray*.

The car's paintwork and polished parts

Protect with the appropriate care products* before and during the winter months.

Radiator and radiator grille

Do not blank off or fit a cover, or else the thermostat, which responds to engine load and outside temperature, will be unable to control engine temperature correctly.



It is a good idea to carry the following items in the car:

Sand, for starting on ice-covered slopes,
A shovel, in case the car has to be dug out of a snowdrift,
A board, to support the car's jack on a soft surface,
A hand brush and ice scraper to remove ice and snow from the body and windows.

BMW snow chains* for all severe winter driving conditions. These can be fitted to various summer or winter tyres, but only in pairs on the driven (rear) wheels. Always observe the tyre manufacturer's safety recommendations. Do not exceed **50 km/h (31 mile/h)** with snow chains fitted.

Take the decision to fit the snow chains in good time. They not only enhance safety in snow and ice but also improve hill-climbing and shorten braking distances. Note, however, that the car handles differently in all circumstances when snow chains are fitted.

Do not leave the snow chains fitted for longer than necessary. Chain wear on a snow-free road surface is many times higher than if the surface is covered with snow.

Comply with national legal requirements. Any BMW service station will provide you with further details.

Winter driving hints

Allow ample time for delays caused by poor weather and road conditions when planning winter journeys. Information on whether main roads can be used is usually available from the press, radio and TV, from automobile clubs or by dialling a special telephone number.

Before starting the journey

Clean ice and snow off the windows, mirrors and lights. After a heavy fall of snow, the snow lying on the roof and the engine and luggage compartments should be removed and the air entries below the windscreen cleared, so that the interior heating and ventilation function correctly.

Before entering the car, the driver should try to remove snow, slush and ice from his or her shoes, in order not to slip off the pedals.

Do not drive the car in ski boots or similar bulky footwear, as this makes it difficult to operate the pedals with the necessary precision.

After a cold start

For the first few kilometres, when the oil is still cold and highly viscous (particularly at temperatures below -15°C), the gear lever may be rather stiff to move and the suspension damping may seem harder than usual (and possibly generate a certain amount of noise).

Easier starting from a standstill

If the car is driven on icy or snow-covered roads or in the mountains and the payload is only slight, 30 to 50 kg (65 – 110 lb) of ballast can be carried in the luggage compartment. Secure it to prevent it from slipping.

Driving on slippery roads

Operate the accelerator pedal sensitively, avoid high engine speeds and shift up to the next higher gear early. On uphill or downhill gradients, select the next lower gear in good time. Maintain a generous distance from the vehicle in front as a safety precaution.

Brakes

Winter road conditions greatly reduce the amount of tyre grip that is available, so that the driver must expect braking distances to be considerably longer than usual in every situation. ABS prevents the wheels from locking, so that the car remains stable and can always be steered. Should the ABS fail and the road wheels therefore lock, reduce pressure on the brake pedal immediately so that the wheels can still turn although they are being braked. Then increase pedal pressure again until the same situation occurs, and repeat this as often as necessary. This "cadence braking" principle cuts braking distances and keeps the car steerable, so that you can try to drive round obstructions at reduced braking pressure.

Warning:

On a slippery surface, do not shift to a lower gear as a means of braking the car, or the rear wheels may lock and cause the car to skid or the driver to lose control. This applies in particular to cars with ASC+T* or DSC* if these systems are defective or switched off. ABS cannot counteract this form of wheel locking.

Note:

When applying the brakes hard on slippery roads or if the amount of surface grip varies widely, always declutch as well.

If the car skids

Take your foot off the accelerator and depress the clutch or move the automatic transmission selector lever to N. Try to steer into the skid and bring the car under control in this way.

Car unable to move

(deep snow, sand or other soft surfaces):

Obtain help to push the car out before its tyres dig deep ruts in the soft surface; if no help is available, place material under the rear wheels to provide more grip (in an emergency, the car's floor mats can even be used). With a degree of skill the car can be rocked out of the ruts by engaging forward and reverse gear several times in quick succession. Do not allow the rear wheels to spin violently, or they will fail to grip and could dig themselves in even deeper. Applying the handbrake lightly will prevent a driven wheel from spinning excessively.

Warning:

If the car becomes immobilized in snow or sand, make sure that the exhaust pipes and the surrounding area are clear of snow or sand when the engine is running. There is otherwise a risk of odourless but highly toxic carbon monoxide entering the car and rendering the occupants unconscious with fatal consequences. Open a window slightly on the side of the car away from the wind to ensure an adequate supply of fresh air.

Parking

Select 1st gear or reverse, or move the automatic transmission selector lever to P. If parked on a slope, apply the handbrake as well. To prevent the handbrake linings from sticking to the drums as a result of frost or corrosion, dry the drums by applying the handbrake lightly as the car is coming to a halt.

After a break in the journey or when refuelling

Remove snow and ice that has built up in the wheel arches in case it interferes with steering or suspension movements.

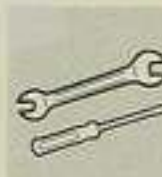

Towing a trailer

When a trailer is towed, the demands on both car and driver are more severe. A trailer reduces manoeuvrability, the ability to climb hills, acceleration and braking capacity and makes the car handle and corner differently.

For the **trailer weight limit** and towbar down-thrust (nose weight), please refer to the "Technical Data" on Page 134. The trailer weight limit is also shown in the car's registration papers (depending on national regulations). Consult any BMW service station regarding increased trailer weights.

Nose weight

This is the load exerted downwards by the trailer on the ball head of the tow hitch attached to the rear of the car (it can be determined with the aid of bathroom scales or similar).

In Germany a minimum nose weight of 25 kg (55 lb) is laid down by law.

If the trailer weighs more than 1600 kg (3527 lb), the nose weight must be at least 50 kg (110 lb). Please comply with local regulations.

The nose weight limit should if possible be fully utilized but not exceeded.

The trailer's nose weight is added to the weight of the car, and must not lead to the car's gross weight limit or rear axle load limit being exceeded. The car's payload is reduced by the nose weight if a trailer is being towed, and also by the weight of the trailer tow hitch.

When **loading the trailer**, make sure that the weight is kept as low as possible and stowed if possible close to the axle.

A low centre of trailer gravity makes the outfit much more stable and safe to drive.

Do not exceed either the trailer's gross weight (axle load) or the specified trailer load limit for the car. The smaller value is the limit which should be adhered to.

The **trailer tow hitch*** with detachable ball head should be of BMW-approved pattern and, like the **trailer turn indicator repeater** (which is normally a legal requirement) should be expertly installed by a BMW service station.

Keep the detachable ball rod greased to make fitting and removal easier.

Note on electrical equipment:

Higher electrical consumption can be expected if a trailer (caravan) is towed. Switch on high-consumption items in particular for as short a period as possible in order to avoid draining the battery.

The trailer's rear lights, brake lights and rear fog light are protected by plug-in fuses in the trailer electrical module. This is behind the left luggage compartment trim. The fuse for the permanently positive line is in the luggage compartment, next to the left battery, in a separate fuse box.

Before acquiring a trailer it is desirable to obtain from the manufacturer a **guaranteed statement of the effective trailer weight and the payload limit**.

Both the "comfort" and "sport" **suspension settings** of your BMW afford optimum safety, ride quality and consistency of handling. They are also perfectly suitable for towing a trailer at up to the standard specified weight (not uprated version), provided that towing is restricted to one vacation period per year or thereabouts, and the driving style is modified to allow for the more severe operating conditions.

If a trailer tow hitch is retrofitted, it is also a good idea to install the **trailer-towing suspension***. This compensates for the weight of the tow hitch and also ensures optimum road behaviour when the trailer is not being towed. It is also essential if higher trailer weights are to be towed (possible with certain types of trailer).

BMW does not approve of any other suspension systems offered by the automotive trade for trailer towing purposes.

Note:

If a trailer tow hitch is installed, the self-regenerating effect of the rear bumper system will be reduced.

The use of a **stabilizing device** can be recommended, particularly if the trailer is a heavy one. Information can be obtained from a BMW service station.

The standard **outside mirrors** may prove inadequate for trailer towing work: the law lays down that the car should be equipped with two outside mirrors with which the rear corners of the trailer can be seen (please check and comply with national regulations in this respect). Mirrors of this kind, including versions with adjustable arms, can be obtained from BMW service stations.

In the interests of safety and the avoidance of traffic obstructions, the **maximum gradient** (applicable at sea level) is limited to 12% or, with a higher trailer load (if authorized), 8%.

As altitude above sea level increases, engine power output tends to drop. You should therefore take particular care when driving through the mountains, since the maximum gradient on which the outfit can be started may be lower than usual. Do not make full use of the car's and trailer's gross weight limits.

Special care must be taken when **descending gradients**, since the trailer brakes are often limited in their efficiency. Always shift down to the next-lower gear at the top of a steep hill (if necessary, right down to 1st gear or by selecting automatic transmission position 1 manually) and descend the hill with great caution.

Before driving in mountain regions, have the serviceability of the trailer brakes checked by an authorized workshop.

Since ABS prevents the car's wheels from locking, you are recommended to provoke the ABS into action if necessary when braking. On roads with a low-friction or slippery surface in particular, the outfit's total braking distance can be distinctly reduced by this procedure.

The **maximum speed limit** when towing a trailer is 80 km/h (50 mile/h) in the Federal Republic of Germany, and similar speed limits apply in other countries also. The trailer load limits have been chosen to ensure ample driving stability up to this speed. If higher speed limits apply in other countries, you are none the less recommended not to drive faster for safety reasons.

If the trailer begins to **swing from side to side**, the outfit can only be stabilized by braking immediately.

Check the car's and the trailer's **tyre pressures** most carefully. Comply with the trailer manufacturer's tyre pressure instructions.

Warning:

Always check that the trailer's rear lights are working before starting a journey.



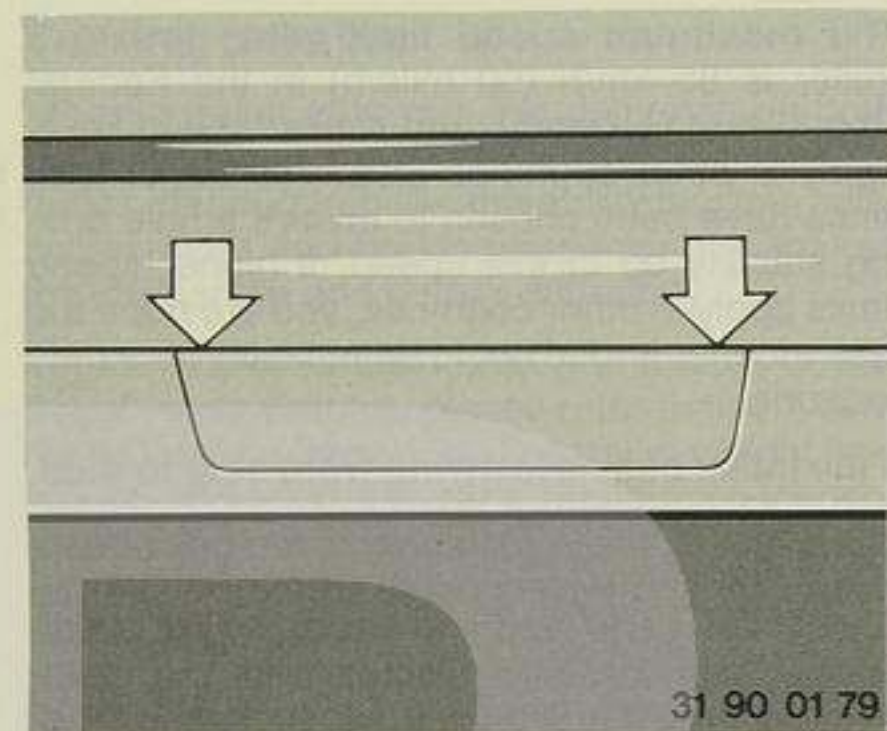

Cover flap for trailer tow hitch

Press the cover down at the left and right ends of the upper joint line with a screwdriver (arrows in picture).

Take off the flap and attach the ball head of the tow hitch.

For attaching and removing the ball head, please refer to the accompanying instructions.

To install the cover flap, insert it into the lower guide and press it in at the top.

Roof rack*

A loaded roof rack alters the car's road behaviour and steering response quite considerably by moving its centre of gravity.

When loading the roof rack, ensure that the specified roof load limit, the car's gross weight limit and the axle loads are not exceeded.

A special roof rack system is available as an accessory for your BMW. If it is used, please comply with the installation instructions supplied.

The roof load must be uniformly distributed and should not be too large in area. Heavy items of luggage should always be placed at the bottom.

Correct, secure loading of the roof rack will prevent items from shifting or falling off during the journey, and thus endangering following traffic.

Drive smoothly when there is a load on the roof: avoid violent acceleration, braking or cornering.

The roof load also increases the car's surface area exposed to the wind, so that fuel consumption will be higher and the loads on the roof structure of the car more severe.

Remember to take off the roof rack when it is not needed.

Comply with national regulations regarding the load on the car.

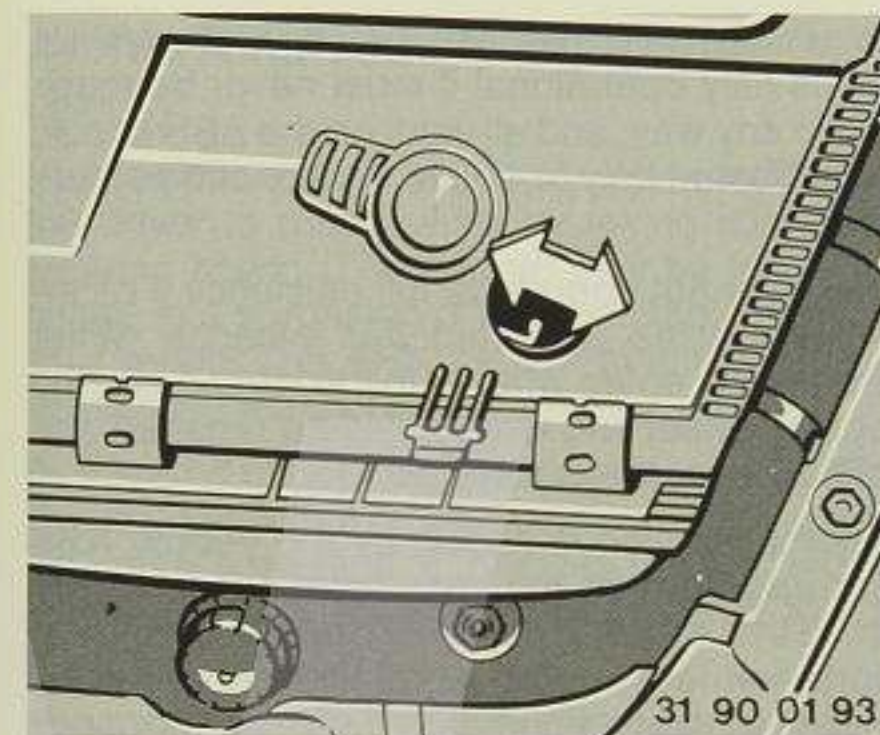

Resetting headlight beams for left/right rule of the road

When entering a country in which the traffic drives on the other side of the road:

- Take off the painted upper section of the pop-up headlight:
Turn the toggle fastener through a quarter of a turn and lift the upper section slightly. Push the upper section forwards and take it off.
- Take out the plug.
- For driving on the left: move the lever to the left.
For driving on the right: move the lever to the right.

Warning:
When attaching the painted upper section of the pop-up headlights, make sure that it is correctly seated, particularly at the front mounting points, and that the toggle fastener is properly secured by rotating through a quarter of a turn.

Licensing car for use abroad

Cars are always supplied to conform with the registration laws of the country in which they are intended for use.

If the owner moves to another country, it is important to check beforehand that import regulations and vehicle licensing laws do not render the importing of the car too difficult.

Information can be obtained by telephoning (Germany) 89-318401 if the model, vehicle identification number and date of first registration are quoted.



Antilock brake system (ABS)

ABS prevents the wheels from locking when the brakes are applied, and thus increases active safety. With ABS in action, the car achieves the shortest possible braking distances for the prevailing conditions (straight-line braking or cornering, on asphalt, ice, wet roads etc.).

ABS is capable of satisfying two fundamental requirements whenever the brakes are applied:

- Assured driving stability on varying road surfaces (e.g. asphalt, concrete, mud, wet roads, snow and ice).
- Assured steerability and manoeuvrability in these conditions.

However, certain important considerations must be borne in mind in connection with these requirements:

Even ABS is unable to eliminate the effects of natural physical laws. It cannot absolve the driver from the consequences of braking too late, maintaining insufficient space from vehicles ahead, exceeding the limits of adhesion when cornering at speed or encountering a poor stretch of road where aquaplaning occurs. Avoiding such situations or coping effectively with them remains the driver's responsibility.

Although ABS enhances active driving safety, this should not be regarded as an invitation to take correspondingly severe risks.

Driving with ABS

After the engine has been started, the yellow **ABS warning light** on the instrument panel goes out.

The ABS system itself becomes operational above a road speed of app. 8 km/h (5 mile/h). If the car's speed falls below 3 km/h (app. 2 mile/h), the ABS ceases to operate, so that the wheels could theoretically lock in the very last phase of braking, but in practice this is hardly critical.

The ABS regulating cycle takes place within fractions of a second. The brake pedal pulsates to warn the driver that the ABS is active and therefore that the car is reaching the adhesion limit. A chattering sound, resulting from the brake pressure regulating process, is also heard, as a reminder that tyre grip is diminishing (low-grip road surface) and that road speed should be lowered accordingly.

If the road surface consists of loose material on a firm underlayer, for instance stone chippings or powdery snow, the car's braking distance may sometimes actually be longer than if the wheels were to lock. The same applies if snow chains are fitted. However, the advantages of greater stability and the ability to steer while braking are still available to the driver.

To ensure that the ABS system always remains fully operational it must never be modified in any way, and all work on the ABS should be entrusted only to skilled, authorized personnel.

ABS may not operate at full efficiency if different tyre sizes are fitted (for instance winter tyres or the spare wheel). In the latter case, the regular wheel and tyre should be repaired and refitted as soon as possible.

Any malfunction is shown by the **yellow ABS warning light** on the instrument panel coming on. In this situation the car's brakes continue to work normally, as on a vehicle without ABS, with no restrictions to their performance whatever.

In order to prevent any multiple faults from impairing the brake system, the necessary repair work should be carried out at the next possible opportunity.

Active Rear Axle Kinematics (AHK)*

Unforeseen driving situations often call upon the driver to react swiftly by taking corrective steering action. The vehicle may be felt to respond in a surprising or unpredictable manner as a result. The AHK system modifies or prevents such reactions.

At a speed of app. 40 km/h or above, the AHK is activated with every adjustment to the steering wheel's position; it modifies the rear wheel lock angle and repositions them ideally to suit the driving situation.

The optimum rear-wheel angle is calculated from the steering wheel's momentary lock angle and the vehicle's road speed; the wheel angles are then adjusted by the electro-hydraulic control circuit. As a result of the vehicle's increased stability, it responds more predictably to steering wheel movements.

However, these improved driving characteristics cannot overcome the basic laws of physics to which a moving vehicle is subject. It remains the driver's responsibility not to initiate excessive steering-wheel movements or overstep safe cornering speeds.

Each time the engine is started, the AHK control unit runs through a self-check sequence. In the event of a system fault, which will be indicated by the telltale light in the instrument cluster and the display "R/AXLE FAILSAFE PROG" in the MID, the lock angle of the rear wheels will no longer be adjusted. The wheels will normally remain in the straight-ahead position, with the result that the vehicle can be driven normally. In exceptional cases, the wheels could remain locked at an angle. If this occurs, to compensate the steering wheel will be slightly offset when the vehicle is travelling in a straight line. Here again, the vehicle can still be driven normally. Note, however, that in this situation the rear wheels will run slightly off-track and the vehicle will occupy marginally more road space across its width as a result.

Minor, temporary faults can be rectified by repeated restarting of the engine to initiate the system's self-check. If the telltale light does not go out even after the engine is restarted, contact a BMW service station to have the system repaired.



Disc brakes

Disc brakes offer maximum braking efficiency, responsive control of braking force and the ability to resist severe loads.

Load capacity of the brakes

Since the brakes reach high temperatures, for instance when descending mountain passes or when the car is driven very hard indeed, they need to be cooled equally effectively. This is achieved only by the airflow across the brakes and the peripheral speed of the rotating discs. If the brakes operate at high temperatures, these will reach the brake fluid and the pads. As a result, the brakes will lose efficiency, pedal travel will increase and more effort may have to be applied. However, the boiling point of the brake fluid is so high that these limits are unlikely to be reached except under genuinely extreme loads or if the car is not driven in a sensible fashion.

Corrosion and dirt

Moisture, dirt, the salt often spread on the roads in winter and corrosion of the brake discs can affect the car's braking performance: braking distances become longer, braking force distribution alters and the friction values at the wheels vary, so that the brakes may pull to one side.

If the car is not driven very far, is parked out of use for lengthy periods or is mostly driven very gently, corrosion of the brake discs and contamination of the pads may unfortunately be encouraged, since the minimum pressures between pad and disc which are needed to obtain an automatic cleaning action are seldom reached.

When the brakes are applied, corroded discs tend to judder, and even lengthy brake applications usually fail to eliminate this effect entirely.

Dirt burnt into the brake pad surfaces, or glazing over as a result of severe heat build-up, tends to score the brake discs, reduce or alter the quality of the braking action and cause squeaking.

Driving hints for cars with disc brakes

If the traffic situation permits, it is a good idea to apply the brakes fairly firmly once or twice from quite a high speed at infrequent intervals. The resulting high pressure enhances the self-cleaning action of the discs and pads.

In the same way, the brakes should be deliberately applied fairly hard at intervals on longer journeys in poor weather conditions, particularly in winter when salt has been spread on the roads. This not only tests the efficacy of the brakes in the prevailing weather conditions (though care must be exercised at temperatures close to freezing point), but each "test brake application" also ensures that the brakes are restored to a fully operational condition, thanks to the resulting self-cleaning effect.

In damp weather or heavy rain it is advisable to apply the brakes with light pedal pressure every few kilometres. This will generate sufficient heat to dry out the discs and pads.

If the car is parked after a journey in the rain or over salt-strewn roads, keep the brakes applied lightly until it comes to a standstill. This will dry the discs and help to delay corrosion.

In the early stages of brake disc corrosion, several powerful brake applications at speed may succeed in eliminating the problem, but great care must be taken not to endanger other road users.

If brake disc corrosion is already severe and the brake pads are contaminated with dirt or glazed over, the discs and pad surfaces must be checked, cleaned and repaired by a BMW service station.

It is a well-known fact that the most effective braking is obtained not with locked wheels but when they are still just rotating. ABS maintains this state of affairs automatically. Should the ABS malfunction, the driver should adopt the cadence braking principle if possible (see Page 109).

Locked wheels are dangerous, because the front wheels cannot then be steered but tend to skid in a straight line, and the rear wheels may slide sideways and cause the car to spin or slide off the road.

To avoid any risk of brake fade when descending long, steep hills, select the gear which calls for a minimum amount of braking (or shift the automatic transmission down to an equivalent speed stage).

Engine braking is more powerful in a lower gear; on a very severe gradient, therefore, you should even shift down as far as first gear or automatic transmission selector position 1 if necessary.

If engine braking alone is insufficient, do not apply the brakes for too long with only slight or moderate force. Instead, it is better to brake the car quite hard (providing that the road behind you is clear) to reduce your speed noticeably, and to repeat this process at brief intervals as necessary. The cooling-down phases between these brake applications should avoid overheating and maintain full braking efficiency.

Warning:

Never hold the clutch pedal down, move the gearbox or automatic transmission into neutral or – an even more dangerous practice – switch off the engine while the car is in motion. Engine braking is lost in neutral, and there is no brake servo effect when the engine is stopped.

Make sure that the full travel of the brake, clutch and accelerator pedals is never obstructed by the floor carpet, loose mats or any other items.



Tyres

Information for your safety

The factory-approved radial-ply (braced tread) tyres have been chosen to match your car's performance and to ensure driving safety and the desired standard of ride comfort.

The condition of the tyres and maintenance of the specified tyre pressures not only influences tyre life but also road safety to a very considerable extent.

Incorrect tyre pressures are often a cause of tyre problems. They also have a considerable effect on the roadholding of your BMW.

For your own safety you are recommended to check tyre pressures **regularly**, before starting a long journey and in any case **at least once every two weeks**.

Make sure in particular that the specified tyre pressures are maintained if the load on the car is increased and when driving at continuous high speeds. Lower pressures than those specified will reduce stability and driving safety, because lateral locating forces are lower. The tyres will be less capable of withstanding high speeds and will heat up more rapidly as a result of excessive flexing. The associated higher roll resistance will cause fuel consumption to deteriorate and could lead to tyre damage and accidents.

It should be remembered that if a tyre suffers concealed damage it may only fail much later or when exposed to a less severe load.

If a tyre loses pressure severely, always have the cause investigated and put right. Remember to check the spare wheel's tyre pressure too, and keep this approx. 0.3 bar (3 – 4 psi) higher than the specified value for heavier loads, so that the wheel can always be fitted without its tyre having to be inflated further. Higher tyre pressures reduce ride comfort and lead to premature tread wear.

Warning:

Over-inflating the tyres can cause tyre damage or, in certain circumstances, sudden loss of pressure, because the tyres are more sensitive to loose objects on the road or sharp-edged potholes.

Tyres are exposed to very severe loads at high speeds, particularly in hot summer weather and when the car is heavily laden. Please comply with the specified higher tyre pressures for heavier loads, and do not exceed the **permitted axle loads**.

Tread depth and tyre damage

Inspect tyres frequently for damage, the presence of foreign bodies, unusual wear and sufficient tread depth.

Although the law in many countries calls only for a minimum tread depth of 1.6 mm (if indeed any minimum figure is laid down), you are recommended to replace tyres when the tread depth is down to 3 mm, or else the risk of aquaplaning even on shallow water will be increased.

Since the danger of aquaplaning always increases with the car's road speed, this should be kept down if the road is wet and the tyres are known to be fairly well worn.

We recommend fitting new tyres when the treads are 3 mm deep. If a tyre remains in use after this, wear indicators 1.6 mm from the main rubber surface are exposed as a sign that the legal wear limit has been reached (this has applied for instance throughout the European Community since January 1, 1992).

The recutting of tyre treads for this car is forbidden, because of the risk of the carcass already having been damaged.

A **sharp object** may penetrate the tyre and cause a slow puncture. The resulting loss of air can only be detected if tyre pressures are checked regularly. If damage of this kind is suspected, the tyre should be inspected without delay by a BMW Service station or an authorized tyre repair shop.

Drive with extreme care and at moderate speed if roads are poor or over unavoidable obstacles such as kerbstones, so that the **tyre carcass** does not incur any damage invisible to the naked eye.

When parking the car or driving over loading ramps, workshop hoists etc., make sure that the **sidewalls of the tyres** are not damaged by violent contact with obstructions.

Warning:

Avoid overloading the car. This can cause the tyres' load capacity limit to be exceeded, so that they overheat and internal damage is caused at a rate which cannot be detected from the outside, possibly leading to sudden pressure loss.

All forms of tyre damage (which could in the worst case lead to sudden and total loss of pressure) represent a risk of serious or even fatal injury to the car's occupants and to all other road users.

Never try to drive any further if a tyre goes flat. If a tyre loses its pressure, it seriously affects the car's handling and braking, and can even cause the driver to lose control.

New tyres

To maintain the car's good road behaviour, always fit tyres of the same make and tread pattern to all wheels. BMW does not approve of the use of retreaded tyres on this car, since their carcasses may differ in internal construction or have aged sufficiently to cast doubt on their durability and therefore in certain circumstances on their road behaviour and safety.

Interchanging wheels and tyres

Tread wear patterns are different at the front and rear wheels.

In the interests of safety and the best possible vehicle behaviour, you are recommended not to adopt the practice of interchanging the wheels.

If it is felt that the wheels should be interchanged for reasons of operating cost, please note the following precautions:

Interchange the wheels on the same side of the car only (though the spare wheel can be included if desired).

Remember that braking efficiency and tyre grip may be adversely affected.

If tyres are interchanged in this way, the process should take place at frequent intervals (max. 5000 km/3000 miles).

Do not continue to use tyres that are more than 10 years old for normal driving unless they have always been used regularly in normal conditions. Failing this, they should be replaced.

Spare tyres more than 6 years old should be reserved for genuine emergencies, that is to say if the car's mobility cannot otherwise be maintained. They should no longer be brought into regular service when new tyres are fitted.

A tyre's date of manufacture is shown as part of the inscription on the tyre wall: DOT ... 251 means for instance the 25th week of 1991.

Wheels and tyres

Use only BMW-approved tyres.

In view of the car's maximum speed, certain makes and sizes are compulsory. Details are available from any BMW service station. Comply in addition with any relevant national regulations.

The correct choice is made easier if the meaning of the tyre markings is understood. Radial-ply tyres are marked as follows:
e.g.

195/65 R 15 91 H

Nominal width in millimetres _____
Aspect ratio in % _____
Code letter for radial ply _____
Rim diameter in inches _____
(TRX and TD tyres: in millimetres)
Load capacity figure _____
(not on ZR tyres)
Speed code letter _____
(ahead of the R on ZR tyres)



The speed code letter indicates the maximum permissible speed at which the tyre is to be operated.

On summer tyres:

- S = up to 180 km/h
- T = up to 190 km/h
- H = up to 210 km/h
- V = up to 240 km/h
- ZR = over 240 km/h

On winter tyres:

- Q M+S = up to 160 km/h
- T M+S = up to 190 km/h
- H M+S = up to 210 km/h

Marks on steel or light alloy wheels:

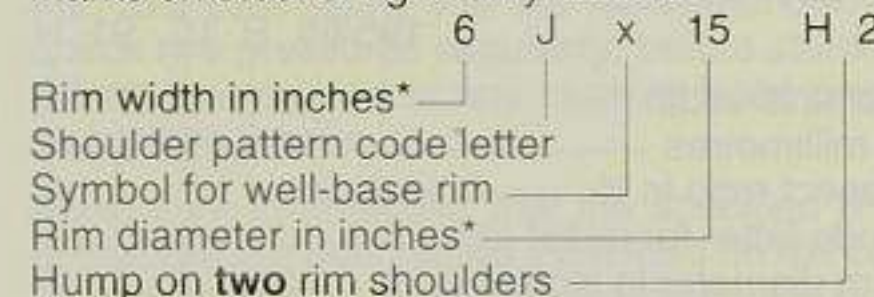

* TR and TD wheels: in millimetres

Prevent dirt from entering the tyre valves with **screw-on dust caps**. Dirt in the tyre valve can often lead to a gradual loss of air pressure.

Winter tyres

If winter tyres (M&S radial-ply) are fitted, the same make and tread pattern should be used on **all four wheels** (and preferably on the spare wheel as well) in the interests of good directional stability and steering response.

Fit only **winter tyres approved by BMW**. Any BMW service station will gladly advise you on the correct winter tyres for the conditions in which your car has to operate.

Always note and comply with the maximum speed limit for your winter tyres.

In the Federal Republic of Germany, a **warning notice** stating the maximum permitted speed with winter tyres fitted must be displayed **in the driver's field of view** if the car is capable of a higher top speed (please check for similar local legislation).

Suitable labels are available from tyre suppliers or **BMW service stations**.

Below a tread depth of 4 mm, winter tyres become noticeably less suitable for winter driving conditions and should therefore be replaced without undue delay for **safety reasons**.

Keep to the specified **tyre pressures** and have the wheels and tyres rebalanced each time the wheels are changed or new tyres fitted.

Note:

Lack of expert knowledge or incorrect handling of tyres can cause damage and lead to accidents.

All work on tyres should therefore be carried out only by experts. Your BMW service station will gladly assist you.

Store wheels and tyres in a cool, dry and preferably dark place when not in use. Protect tyres against contamination with oil, grease and fuel.

BMW-approved wheel and tyre sizes for summer and winter:

Radial-ply tyres (tubeless)	Pressed-steel wheel	Light alloy wheel	Wheel offset mm
BMW 840Ci, BMW 850Ci			
225/55 R 16 95 Q/T/H M+S	–	7 1/2 J x 16 H2	15
235/50 ZR 16	–	7 1/2 J x 16 H2	15
235/50 R 16 95 Q/T/H M+S	–	7 1/2 J x 16 H2	15
235/45 ZR 17	–	8 J x 17 H2	15
235/45 R 17 93 Q/T/H M+S	–	8 J x 17 H2	15
265/40 ZR 17*	–	9 J x 17 H2	19
BMW 850 CSi			
235/45 ZR 17	–	8 J x 17 H2	10
235/45 R 17 93 Q/T/H M+S	–	8 J x 17 H2	10
265/40 ZR 17*	–	9 J x 17 H2	19

* Only permissible as a mixed set of tyres with 235/45 ZR 17 at front. Snow chains cannot be fitted.

Note the tyre and wheel data in the car's official documents. If sizes not approved by the manufacturer are fitted, an entry in the car's documents may be necessary. Comply with local legislation.

Winter tyres

Same tyre and wheel size combinations as for summer tyres, with the exceptions stated.

BMW fine-link snow chains* may be used with either summer (not on BMW 850CSi) or winter tyres, and must then be fitted to both back wheels. Always observe the tyre manufacturer's safety recommendations when fitting.

Technical modifications to the car

Any BMW service station can provide you with information as to the practical value of an intended modification and whether it is legally permissible and approved by the manufacturer. Enquiries should be accompanied by the vehicle identification number and, if relevant, the engine number.



The BMW maintenance system	124
Care of the car	125
Laying the car up out of use	130



The BMW maintenance system

The BMW maintenance system has been planned to ensure that the car always remains safe for the road and reliable, without any unnecessary expense for the customer. Regular and correct maintenance also helps to maintain the car's resale value.

Advanced technologies have been adopted as a means of computing maintenance requirements, which are then shown on the Service Interval indicator. Whereas conventional maintenance schedules are based entirely on fixed distance intervals, the BMW maintenance system takes the car's operating conditions into account, bearing in mind that "one kilometre is not the same as another": 100,000 km completed exclusively in the form of short journeys cannot be equated with 100,000 km made up of long main-road journeys only.

The BMW maintenance system based on actual operating conditions consists of an Oil Service and Inspections I and II.

For further information on maintenance points and the scope of maintenance work, please refer to the car's Service Booklet.

Basing service intervals on the actual loads incurred accounts for most regular operating situations. However, if the car is very little used, that is to say if it covers distinctly fewer than 10,000 kilometres (approx. 6,000 miles) a year, an annual engine oil change should be carried out, since the engine oil ages even if not subjected to mechanical loads.

It may also be worthwhile to have the body checked for stone-impact damage at the same time, in order to safeguard against corrosion.

Please make sure that the maintenance work is confirmed in the car's Service Booklet. These entries are evidence that your car has been serviced regularly and correctly, and are also needed, for example, if a warranty claim has to be submitted.

Care of the car

The car's paintwork is built up in **several layers**, for protection against corrosion. In addition to dip coating with primer, the body cavities are specially protected with materials that have been subjected to stringent and successful testing for a number of years.

The entire underside of the floor pan is sprayed with a resilient PVC coating and then protected by a complete wax-based underseal coating.

Always remember that regular care of your car will go a long way towards maintaining not only its safe condition but also its resale value.

Environmental influences which differ from one region to another can affect your car's paintwork; the nature and frequency of the care you give the car should be governed by these factors.

Road dirt, tar stains, dead insects, bird droppings (powerful alkaline action) and also resin and pollen from trees and bushes all contain substances which could damage the paint surface after a period of time (stains, blistering, caustic burns, peeling off of the top paint layer).

In **industrial areas**, airborne fly ash, lime, oily soot acid rain or sulphur dioxide as well as other impurities in the air are bound to attack the paintwork, though in most cases only the horizontal panels surfaces are affected.

In **coastal regions** the high salt content and humidity of the air encourages more rapid corrosion.

In **tropical regions**, ultra-violet radiation is more powerful, atmospheric humidity usually higher and temperatures can reach more than 40°C in the shade. On light-coloured cars, the painted surfaces can reach up to 80°C, with darker paintwork even reaching 120°C in the sun. Lengthy exposure to such conditions can cause the paint to crack, particularly on horizontal panels.

In the case of **mechanical loads** caused by sand, road salt, stone chippings or similar, the paint surface may be broken and corrosion may then be able to develop under the paint, and spread out from the damaged areas.

Awareness of these negative environmental effects on the paintwork has stimulated motor vehicle and paint manufacturers to increase the durability and strength of their paints wherever possible.

The paints used by BMW represent the latest state of technical development in their composition and in the methods used to apply them.

BMW service stations supply factory-tested Original BMW car care products for all general work of this kind which you intend to carry out yourself.

Care of paintwork

As a precaution against the long-term effects of substances which attack the paintwork in areas where air pollution is high (industrial areas, railways) or where natural pollutants are encountered (tree sap or resin, pollen, bird droppings), you are recommended to **wash the car once a week**. In particularly severe cases, the car's body should be washed immediately any such signs of potential damage are detected.

Spilled or overflowing fuel, oil, grease and brake fluid must be **removed immediately** or else they will attack or discolour the paint; the same applies to bird droppings, which will cause local damage to the paint.



Car wash

A new BMW can be put through an automatic car wash, or washed by hand, immediately.

However, do not wash the car in the sun, immediately after it has stood in the sun or when the engine compartment lid is still warm, in order to avoid blotches on the paintwork.

If an **automatic car wash** is used, make sure that

- add-on body elements such as spoilers cannot be damaged. If in doubt, consult the car wash operator first.
- the brush pressure must be as low as possible, and the car wash should operate with ample rinsing water.

Modern car washes normally satisfy these requirements.

Before washing the car, it is best to soak and wash off dead insects as far as possible.

Body areas not always reached effectively by the car wash brushes, such as door sills, door seams and panel gaps should be cleaned by hand.

During the winter months in particular, wash the car more frequently. Severe dirt and road salt are difficult to remove and tend to damage the paintwork if not removed promptly.

If the car is **washed by hand**, moisten the dirt on the surface with a finely distributed water spray if possible, and rinse off. Avoid spraying water into the heating and ventilation inlet and outlet apertures.

Next, wash the car down with a sponge, wash glove or similar, using plenty of water which should be warm but not hot, and starting with the roof. Rinse out the sponge at frequent intervals to keep it clean.

Clean the lower body panels and wheels last of all, if possible with a different sponge.

After washing down, spray the car thoroughly and dry it with a clean wash leather to prevent patches from forming.

A **paint protection product*** can be added to the wash water if desired.

If washing with water only is not sufficient, a **car shampoo*** of a type which restores fats to the paintwork can be used in the recommended concentration. Rinse off afterwards with plenty of water.

Warning:

After the car has been washed, the brakes may be damp and therefore less efficient. Dry the brake discs by applying them briefly as soon as the car is driven.

After washing, residual dirt will be clearly visible. It should be removed without delay, using cleaning-grade benzene or white spirit on a clean cloth or wadding. Clean off tar stains with a **tar remover***.

Finally, apply a paint protection product to the treated areas.

For **paint protection**, use only products containing carnauba or synthetic waxes.

A sure sign that the paintwork needs protective treatment is when water no longer forms large droplets and rolls off the surface. Depending on how and where the car is used, this can be the case after only 3 to 4 months.

If the paintwork begins to lose its gloss as a result of insufficient care, it can be treated with a suitable **polish***. If the paint is already dull or weathered, it should be treated with a **paint cleanser***. Use **cutting paste*** or similar aggressive products only in severe cases. Remember that polishes, cleansers and pastes all take effect by removing the damaged paint surface and exposing undamaged paint. Surfaces restored in this way should then be carefully protected in order to retain the car's sparkling appearance.

Remove care product residues and silicone from the windscreen with **glass cleaner***.

Minor paint damage can be touched in with a **BMW paint spray can*** or a **BMW paint pencil***, or repaired with **BMW paint film***.

Your car's paint finish is stated on a label close to its type plate, and also on the first page of the Service Booklet.

Scratches and damage caused by flying stones must be repaired immediately, to prevent rust from forming.

If any areas of the body have already started to rust as a result of paint damage, clean them with a wire brush and apply a rust inhibitor or converter (protect the eyes and skin). Allow to act for several minutes, then rinse off with water and allow the treated area to dry thoroughly. Apply primer and allow this too to dry thoroughly, then apply the top coat. After a few days, polish the repainted areas and apply paint protection.

More widespread paint damage should be entrusted to a BMW service station, which can repair it expertly in accordance with the manufacturer's specifications and using Original BMW paint materials.

Warning:

Car covers intended as weather protection (particularly if made of synthetic material) can damage the paint by scratching, moisture condensation or the diffusion of plasticizers. The car's body is more effectively protected against ultra-violet radiation, air pollution and weather effects by thorough care or, in severe cases (for instance when on vacation in a very hot, sunny climate), by erecting a sailcloth cover or similar about 50 to 80 cm (20 to 30 in) above the car's roof.

Annual cleaning, protection work and repeat treatment as required on the engine, engine compartment, underbody, axles and mechanical assemblies is undertaken by BMW service stations with special equipment. It provides a high degree of **protection against corrosion**, prevents electrical short-circuits and creepage and enables leaks to be detected in good time. This treatment is particularly important at the end of the winter season.

The bumpers, trim strips, wheel covers if fitted and similar exposed items should be washed regularly with water (with a **car shampoo*** added if necessary) and then given protective treatment, particularly if road salt is spread by the authorities in winter.

Light alloy wheels should be treated with **wheel cleaner***, but do not use products which are of an aggressive nature, contain acid or abrasives or are strongly alkaline. Steam jets used to clean the wheels should not reach a temperature of more than 60°C. (In all cases, comply with the manufacturer's instructions.)

The insides of the windows and the mirror glasses can be cleaned with a **glass cleaner*** which leaves no smears. Never clean mirror glasses with products containing quartz or similar abrasive polishing pastes.

Plastic parts, imitation leather upholstery or trim, roof linings, light glasses and parts sprayed with matt black paint must be cleaned with water to which a **car shampoo*** can be added if required. Do not allow the roof lining to become wet right through. If necessary, treat plastic parts with a **plastic cleaner***. Never use solvents such as nitro thinners, cold cleanser, fuel or similar.

Apart from water, treat **rubber parts** only with **rubber care products*** or **silicone spray***.

Clean the **wiper blades** with soapy water. They should be renewed twice a year (before and after the winter season).

Seat belts should only be cleaned with mild soap suds (without removing them from the car). Do not dry-clean or use chemical products, or the fabric may be weakened.

Never allow automatic seat belts to retract unless they are dry. Dirt on the seat belts can interfere with the action of the reel and represent a safety hazard.



* Available from BMW service stations

* Available from BMW service stations

Floor carpets and mats* can be cleaned with a **car interior cleaner*** if very dirty. The floor mats can be taken out of the car to enable the interior to be cleaned more thoroughly.

Care of upholstery materials

The pressure areas which occur when cloth seats are in regular daily use can be restored by brushing against the pile direction with a slightly moistened brush.

The tendency of the pile to lie in a particular direction on velour upholstery is not a quality defect, and, just as on home textiles or clothing, cannot be avoided.

Remove fluff from cloth upholstery and rubbed-in threads or scraps of cloth or suede with a suitable **fluff roller*** or **burr brush***. Stains and fairly large areas of dirt should be cleaned off without delay, using lukewarm water and an **interior cleaner***, **stain remover*** or **cleaning-grade benzene***. Brush the fabric afterwards to restore its appearance.

Cover the seats if exposed to hot summer sun for lengthy periods, so that the upholstery does not fade.

The build-up of a **static electrical charge** on the seats, particularly if atmospheric humidity is low, can give the occupants an unpleasant electric shock if they touch metal parts of the car **after** leaving it. Although this is not dangerous in any way, it can be avoided by touching a bare or polished metal part of the car **while** getting out.

If necessary, anti-static products can be used to eliminate this effect to a large extent.

Care of leather

The **upholstery leather*** used by BMW is a natural product of the highest quality, processed by the very latest methods, and will retain its fine appearance for many years if correctly treated.

Since leather is an absolutely natural product, its characteristics and certain restrictions on its use and special care precautions must be noted.

Regular cleaning and care are needed, since dust and dirt, for instance from the roads, collect in pores and creases, cause severe abrasion and can lead to the leather surface becoming prematurely brittle.

If exposed to strong sunlight when the car is parked for a lengthy period, leather-upholstered seats should be covered or the windows blanked off to prevent fading.

To clean, slightly moisten a cotton or woollen cloth with water and rub the leather surface gently without allowing moisture to collect in the seams. Dry and rub down with a clean, soft cloth.

Leather that has become very dirty can be cleaned with a mild detergent containing no brighteners (2 tablespoons in 1 litre of water). Dab grease or oil stains carefully with cleaning-grade benzene, without rubbing them hard.

After cleaning, glossy leather surfaces should be treated with a suitable **leather care product*** to protect them and prevent the build-up of a static electrical charge. Shake well and apply a thin coating with a soft cloth. Allow to dry and rub with a clean, soft cloth.

In normal conditions, repeat this treatment every six months.

Water-buffalo leather*

For regular care, use only the special **leather spray*** in accordance with the instructions supplied.

Wipe off water droplets immediately, and try to avoid making the water-buffalo leather too wet with clothing in wet weather, or when cleaning.

More severe dirt can be removed with a mild detergent containing no brighteners (2 tablespoons to 1 litre of water).

Water-buffalo leather is left largely in its natural condition and may therefore exhibit slight differences in colour. These and other natural features like healed scars and scratches, insect bites, creases and a degree of patina after a period of use are perfectly normal and typical of this material. New water-buffalo leather, if damp, may slightly discolour light clothing.

Warning:

Keep cleaning products out of the reach of children. Many products are toxic or flammable, and therefore hazardous in use. Before using any such product, study and comply with the instructions supplied with it, and note any warnings or precautions stated on the pack.

When cleaning the car's interior, always open a door or window. Never use products or solvents not specified for cleaning the car.

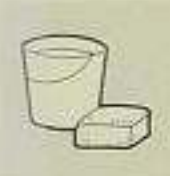

* Available from BMW service stations

* Available from BMW service stations

Laying the car up out of use

If the car is to be taken out of use for **more than three months**, have the following maintenance work performed by the BMW service station:

1. Cleaning and protective coating (or repeat treatment) of the engine, engine compartment, underbody, axles and mechanical assemblies in accordance with the manufacturer's specifications. Car body wash, interior cleaning and protective treatment of paint and chrome. Cleaning lid and door rubber seals and rubbing them with talcum or glycerine oil.
2. Changing the engine oil while warm and renewing the filter element. As an additional engine corrosion protection measure, a corrosion inhibitor can be added to the fuel according to the supplier's instructions.
3. Checking coolant level and concentration, and correcting if necessary.
4. Checking battery-cell acid level and topping up with distilled water if necessary.
5. Draining the windscreen washer system's tank and lines.
6. Filling the fuel tank to the brim in order to prevent the formation of moisture condensate.
7. Increasing tyre pressures to 4 bar (app. 57 psi).

Immediately before laying up the car, the following work must be carried out:

1. Apply the handbrake and the foot brake while the car is in motion, to dry the discs and drums and prevent corrosion.
2. Park the car in a dry, well-ventilated indoor area, select reverse gear or automatic transmission position P and chock the wheel if there is any risk of the car moving. Do not apply the handbrake.
3. Remove the batteries, recharge them and store in a cool place but where there is no risk of frost.

During the laying-up period, carry out the following work:

1. At intervals of not more than 3 months, recharge the batteries or else they will become unserviceable. The batteries' operating life is reduced each time they are discharged, especially over longer periods of time.
2. At least once a month, run the air conditioning (even in the cold season of the year), or else the compressor shaft seal may dry out and allow refrigerant to escape. While doing this, allow the engine to run until its normal operating temperature is reached (coolant temperature gauge needle approximately midway between the two coloured zones), to avoid moisture condensate formation and internal engine corrosion.

Warning:

If the car's engine has to be run in an enclosed space, make sure that there is adequate ventilation, so that toxic exhaust gas is not inhaled.

Licensing

If the car has been registered with the authorities as withdrawn from the road, note the legal limit for re-registration, in order to avoid invalidating the car's general operating permit.

Comply with national regulations in this respect.

Starting the car up again

Recharge the batteries or replace them if necessary.

Have Inspection I performed by a BMW service station.

Warning:

Periods of time in which the car's battery is disconnected are disregarded by the service interval indicator when calculating the need for brake fluid renewal.

Take any such periods into account with regard to the specified brake fluid renewal intervals, and do not wait until the clock symbol lights up.

Engine data, fuel consumption	132
Dimensions	133
Weights	134
Performance	135
Filling capacities	136
Transmission ratios	137
Electrical system	137
V-belts	137



Engine data, fuel consumption

		BMW 840Ci	BMW 850 Ci	BMW 850 CSi	
Displacement	cm ³	3982	4988	5576	
Number of cylinders		8	12	12	
Max. power output	kW	210	220	280	
	bhp	286	300	380	
at engine speed	1/min	5800	5200	5300	
Max. torque	Nm	400	450	550	
at engine speed	1/min	4500	4100	4000	
Compression ratio	ε	10.0	8.8	9.8	
Bore/stroke	mm	80/89	84/75	86/80	
Mixture control	Digital Motor Electronics				
Fuel consumption acc. to DIN 70030/1 ECE		Auto.	6-speed	Auto.	6-speed
at 90 km/h	litres/100 km	7.7	8.8	8.6	8.5
(56 mile/h)	(Imp. mile/gal)	36.7	32.1	32.8	33.2
at 120 km/h	litres/100 km	9.3	10.4	10.3	10.2
(75 mile/h)	(Imp. mile/gal)	30.4	27.1	27.4	27.7
Urban cycle	litres/100 km	17.2	19.8	19.8	19.8
	(Imp. mile/gal)	16.4	14.3	14.3	14.3
Average	litres/100 km	11.4	13.0	12.9	12.8
	(Imp. mile/gal)	24.8	21.7	21.9	22.1

Note:

Fuel consumption is determined according to standard test methods (DIN 70030/1 ECE). It is not the same as the average fuel consumption, which depends on a great many different factors such as driving style, load, road condition, traffic density and flow, weather, tyre pressures etc.

Engine power output and performance are measured in accordance with the conditions laid down by the valid German industrial standards (DIN), and with the car to standard equipment specification. This standard specifies the permitted tolerances.

Optional extras often have a considerable influence on performance and fuel consumption, since they cause the car's weight or its drag coefficient to vary (roof rack, wider tyres, additional mirrors etc.).

Dimensions

		BMW 840Ci	BMW 850Ci	BMW 850CSi
Length	mm (in)	4780 (188.2)	4780 (188.2)	4780 (188.2)
Width	mm (in)	1855 (73.0 in)	1855 (73.0 in)	1855 (73.0 in)
Height (unladen)	mm (in)	1340 (52.8)	1340 (52.8)	1330 (52.4)
Wheelbase	mm (in)	2684 (105.7)	2684 (105.7)	2684 (105.7)
Front overhang	mm (in)	1045 (41.1)	1045 (41.1)	1045 (41.1)
Rear overhang	mm (in)	1051 (41.4)	1051 (41.4)	1051 (41.4)
Front track	mm (in)	1554 (61.2)	1554 (61.2)	1564 (61.6)
Rear track	mm (in)	1562 (61.5)	1562 (61.5)	1554 (61.2)
Turning circle (wheels)	m (ft)	10.6 (34.8)	10.6 (34.8)	10.6 (34.8)
Turning circle (overall)	m (ft)	11.5 (37.7)	11.5 (37.7)	11.5 (37.7)



Weights

		BMW 840Ci	BMW 850Ci	BMW 850CSi
Unladen weight (ready for road, tank full, without optional extras)	kg (lb)	–	1790 (3946)	1865 (4112)
	(with automatic transmission)	kg (lb)	1860 (4101)	–
Gross weight limit (with automatic transmission)	kg (lb)	–	2210 (4872)	2300 (5071)
	kg (lb)	2230 (4916)	2210 (4872)	–
Front axle load limit	kg (lb)	1115 (2458)	1090 (2403)	1150 (2535)
Rear axle load limit	kg (lb)	1150 (2535)	1135 (2502)	1200 (2646)
Trailer loads (according to manufacturer's directives and as legally authorized in Germany)*				
unbraked	kg (lb)	750 (1653)	750 (1653)	–
braked, max. gradient 12% (1 in 8.3)	kg (lb)	1600 (3527)	1600 (3527)	–
braked, max. gradient 8% (1 in 12.5)	kg (lb)	2000 (4409)	2000 (4409)	–
Please consult BMW Service if you wish to tow a heavier trailer.				
Trailer nose weight only if car has BMW trailer suspension	kg (lb)	50 (110)	50 (110)	–
	kg (lb)	75 (165)	75 (165)	–
Roof load	kg (lb)	75 (165)	75 (165)	75 (165)
Do not exceed either the axle load limits or the car's gross weight limit.				
Luggage capacity acc. to VDA test	litres (cu.ft)	320 (11.3)	320 (11.3)	320 (11.3)

* Note that values may differ for certain national-market versions.

Performance

		BMW 840Ci	BMW 850Ci	BMW 850CSi	
Top speed (governed)	km/h (mile/h)	–	250 (155)	250 (155)	
	With automatic transmission	250 (155)	250 (155)	–	
Acceleration	km/h (mile/h)	s	s	s	
	from	0–50 (0–31)	3.1*	2.5/3.1*	2.5
		0–80 (0–50)	5.4*	4.8/5.2*	4.6
		0–100 (0–62)	7.4*	6.8/7.4*	6.0
		0–120 (0–75)	9.8*	8.9/9.6*	8.2
80–120 km (50–75 mile/h) in 4th gear		–	6.0	5.9	
Standing-start kilometre		27.4*	26.3/27.0*	25.5	

* with automatic transmission.



Filling capacities

	840Ci	850Ci	850CSi	Note
	Litres (Imp. units)	Litres (Imp. units)	Litres (Imp. units)	
Fuel tank	app. 90 (19.8 gal)	app. 90 (19.8 gal)	app. 90 (19.8 gal)	Fuel grade: see Page 18
Windscreen washer	app. 2.5 (4.4 pints)	app. 2.5 (4.4 pints)	app. 2.5 (4.4 pints)	For further details, see Page 88
Headlight cleaning system Models with AHK (filler located in luggage compartment)	app. 9.0 (15.8 pints) app. 4.5 (7.9 pints)	app. 9.0 (15.8 pints) app. 4.5 (7.9 pints)	— app. 4.5 (7.9 pints)	
Intensive cleaning system	app. 1.0 (1.8 pints)	app. 1.0 (1.8 pints)	app. 1.0 (1.8 pints)	
Cooling system, incl. heater circuit	12.5 (22.0 pints)	13.0 (22.9 pints)	13.0 (22.9 pints)	For further details, see Page 88
Engine with filter renewal	7.5 (13.2 pints)	7.5 (13.2 pints)	7.5 (13.2 pints)	Brand-name HD oil for spark-ignition engines Oil grades: see Page 85
Manual gearbox	—	2.3 (4.0 pints)	2.3 (4.0 pints)	ATF*
Automatic transmission	—	app. 3.5 (6.2 pints)	—	ATF* BMW 840Ci: Permanently filled without oil changes. Apart from inspection work, there are no plans for oil level checks to avoid incorrect fluid levels. Contact a BMW service station in exceptional cases.
Final drive	1.9 (3.3 pints)	1.9 (3.3 pints)	1.9 (3.3 pints)	Brand-name hypoid gear oil*

* BMW service stations are familiar with the correct grades

Gear ratios

Manual gearbox	850Ci	850CSi
	1st	4.25
2nd	2.53	2.53
3rd	1.68	1.68
4th	1.24	1.24
5th	1.00	1.00
6th	0.83	0.83
Rev.	3.89	3.89

Automatic transmission	840Ci	850Ci
	1st	3.55
2nd	2.24	1.48
3rd	1.54	1.00
4th	1.00	0.73
5th	0.79	—
6th	—	—
Rev.	3.68	2.09

Electrical system

Batteries in luggage compartment
2 x 12 Volt, 65 Amp/h

Firing order
BMW 840Ci
1-5-4-8-6-3-7-2
BMW 850Ci
BMW 850CSi
1-7-5-11-3-9-6-12-2-8-4-10

Ignition timing
On cars with Digital Motor Electronics engine management, the ignition timing is programmed and cannot be adjusted manually.

Alternator 140 Amp, 1960 Watts with built-in voltage regulator

2nd alternator* 33 Amp, 460 Watts

Spark plugs
BMW 840Ci
NGK BKR 6 EK (double-earth electrode)
BMW 850Ci, BMW 850CSi
Heat value 145
Bosch F 8 LCR 2
Electrode gap 0.7 + 0.1 mm
NGK BKR 7 EK (double-earth electrode)

V-belts

BMW 850Ci, BMW 850CSi

Alternator and power steering
Ribbed 6 K x 1080 mm

Water pump and air conditioning
Ribbed 5 K x 1165 mm

Water pump, air conditioning and 2nd alternator
Ribbed 5 K x 1190 mm

2nd alternator
Ribbed 3 K x 590 mm

BMW 840Ci

Water pump – alternator and power steering
Ribbed 7 K x 980 mm

Compressor for air conditioning
Ribbed 7 K x 980 mm



ABS 114
 Acceleration 135
 Acid level, battery 91
 Active Rear Axle Kinematics (AHK) 115
 Telltale light 9, 11
 Aerial 74
 AGS (Automatic Transmission Control) 60
 AHK (Active Rear Axle Kinematics) 115
 Airbag 33
 Air conditioning 68
 Air conditioning, automatic 66
 Alarm system 25
 Alternator 137
 Antifreeze 107
 Antilock brake system 114
 Warning light 9, 11
 Anti-theft alarm system 23
 Operation at door locks 23
 Operation by remote control 25
 Anti-theft wheel studs 100
 ASC+T (Automatic Stability Control plus
 Traction) 63
 Ashtray 72
 Automatic air conditioning 66
 Automatic intensive cleaning 39
 Reservoir 89
 Automatic-reel seat belts 33
 Care 127
 Automatic Stability Control plus Traction
 (ASC+T) 63
 Automatic transmission 60
 Oil capacity 136
 Ratios 137
 Automatic Transmission Control 60
 Average fuel consumption 48
 Average speed 47
 Axle load limits 134
 Backup lights 56, 104
 Batteries 91, 137
 Acid level 91
 Charge telltale light 9, 10
 Starting when flat 96
 Battery acid level 91
 Battery charge warning light 9, 10
 Beam throw adjustment 38
 Body cavity protection treatment 125
 Body protection treatment 126, 130
 Bonnet 80
 Boot 24, 101
 Capacity 134
BRAKE ASSIST INACT. 53
 BRAKE LIGHT CIRCUIT 53
 1 BRAKE LIGHT FAIL 54
 BRAKE LIGHTS FAILURE 53
BRAKE LININGS (brake pads) 54
 Brake system and steering hydraulics 86
 Warning light 11
 Brakes
 Brake fluid 87
 Brake lights 104
 Brake system 90
 Disc brakes 116
 Handbrake 55
 Running in 16
 Winter operation 107
 Bulb changing 102
 Car radio 78
 Car telephone 79
 Caravan towing 110
 Care of car 125
 Care of leather 128
 Care of paintwork 125, 127
CATALYST OVERHEAT 54
 Catalytic-converter cars 76
 Central locking 23
 Changing wheels 119

Charge warning light 9, 10
 Chassis number, see vehicle identification
 number 81
CHECK BACKREST LOCK 54
 CHECK CONTROL 53
 Warning light 9
 CHECK CONTROL OK 55
CHECK ENGINE OIL LEV 55
CHECK LEFT BACKREST 53
CHECK RIGHT BACKREST 53
 Child restraint systems 34
 Cigarette lighter 72
 Cleaning systems, see wipe/wash system
 Clock 44
 Code, see immobilizing the car 51
 Cold starting 15
 Compression ratio 132
 Computer 46
 Convenient opening/closing of windows and
 sun roof 23, 40, 41
 Coolant 107
 Telltale 13, 88
 Temperature gauge 13, 88
 Coolant level equalizing tank 88
 Cooling system 88
 Capacity 136
 Coolant temperature 53
 Corrosion protection 125
 Cruise control, automatic 62
 Date display, see digital clock 44
 Daytime driving lights 36, 103
 Deadlock 23
 Operation at door locks 23
 Operation by remote control 25
 Demisting windows 67
 Differential, see final drive
 Digital clock 44
 Dimensions 133
 Dipped-beam headlights 36, 102

Disc brakes 116
 Displacement 132
 Distance recorder
 Trip distance recorders 12
 Door locks 23
 Care in winter 107
 Heating 23
 Driver's area 8
 Driver's door lock heating 23
 Driving hints 76
 Winter 107
 DSC (Dynamic Stability Control) 65
 Dust caps, tyre valves 120
 Dynamic Stability Control (DSC) 65
 Economy 17
 EDC (Electronic Damping Control) 63
 Electric steering wheel adjustment 30
 Electric seat position adjustment 28
 Electric roller sun blind 71
 Electric windows 40
 Electrical system 137
 Electronic Damping Control (EDC) 63
 Electronic Power Control (EML) 10
 EML (Electronic Power Control) 10
 Energy-conscious driving 17
 Engine
 Data 132
 Output 132
 Starting 15
 Stopping 15
 Torque 132
 Engine compartment 81, 82
 Light 80, 106
 Engine compartment lid 80
 Engine oil, see Oils 83, 136
ENGINE OIL PRESS LOW 53
 Engine size 132
 Engine speed 132

FASTEN SEAT BELTS 55
F/FOG LIGHT FAILURE 54
 Filling capacities 136
 Final drive
 Running in 16
 Oil capacity 136
 Fire extinguisher 93
 Firing order 137
 First-aid box 94
 Flashing turn indicators 37, 103
 Fluid for washers and cleaning systems 89
 Fog lights 37, 102
 Folding rear seat backs 73
 Footwell lights 38, 106
 Fuel
 Average consumption 48
 Consumption 17, 132
 Display 13
 Refuelling 18
 Tank capacity 136
 Telltale lamp 13
 Fuel consumption, average 48
 Fuel tank 18
 Telltale light 13
 Fuel gauge 13
 Tank capacity 136
 Fuses 93
 Gearbox/transmission
 Automatic transmission 60
 Manual gearbox 56
 Oil grade, see Oils 136
 Ratios 137
 Generator, see Alternator 137
 Glove boxes 71
 Gross weight 134
 Handbrake 55
 HANDBRAKE ON 53
 Running in 16

Hand lamp 71
 Hazard warning flashers 37
 Head restraints 28
 Headlight beam throw adjustment 38
 Headlight flasher 37
 Headlights 102
 Beam throw adjustment 38
 Cleaning system 39
 Resetting when driving on opposite side 113
 Switch 36
 Washer fluid 89
 Heated rear window 69
 Heating, see automatic air conditioning 66
 Height 133
 High-beam headlights 37, 103
 Hood (engine compartment) 80
 Horn 13
 Identification number, vehicle 81
 Ignition timing 137
 Ignition-starter switch 14
 Immobilizing the car 51
 Independent heating/ventilation control 50, 70
 Infra-red transmitter 25
 Instrument lighting 36
 Instrument panel 9
 Intensive cleaning system 39
 Fluid reservoir 89
 Interchanging wheels 119
 Interior light 38, 106
 Automatic delay circuit 38
 Interior mirror 32
 Jack 97
 Jumper leads 96
 Keys 22
 Kick-down 58
 Laying up the car out of use 130

- Leather care 128
- Left-hand rule of the road 113
- Length 133
- Licence plate light 105
- Licensing abroad 113
- Light switch 36
- LIGHTS ON 55
- Limit speed 48
- Locks, see Door locks
- LOW BEAM FAILURE 54
- Low-beam headlights 36, 102
- LOW BRAKE FLUID** 53
- Luggage compartment 24, 101
 - Capacity 134
- Lumbar support 29

- Make-up mirrors 32
- Main headlights 37, 103
- Main light switch 36
- Maintenance 124
- Maintenance system 124
- Manual gearbox 56
 - Oil content 136
 - Ratios 137
- Maximum speed 135
- Memo function 44
- Memory for seat, mirror and steering wheel positions 33
- Microfilter 69
- MID (Multi-information Display) 42
- Mirrors
 - Door 31
 - Electric heating 32
 - Interior 32
 - Make-up 32
 - Position memory 33
- Modifications, technical 121
- Motor, see Engine
- Multi-information Display 42

- Nose weight limit 134
- NUM PLATE LIGHT FAIL 54
- Number plate light 105

- Octane number 18
- Odometer 12
- Oils
 - Additives 85
 - Checking level 83
 - Dipstick 83
 - Engine oil capacity 136
 - Gearbox/transmission oil capacity 136
 - Grades 85
 - Telltale light 9, 10
- On-board computer 46
- Outside mirrors 31
- Outside temperature display 47
- Overhang 133

- Paintwork care 125, 127
- Parking lights 37, 103
- Performance data 135
- Pop-up headlights 36, 101, 102
 - Automatic cleaning 39
 - Manual extension/retraction 101
- Power steering 90
 - Oil level check 86
- Power output, nominal 132

- Radial-ply tyres 118, 121
- Radiator 88
- Radiator cap, see Radiator header tank
- Radiator header tank 88
- Radio 78
- Radio aerial 78
- Reading lights 38, 106
- Rear fog light 37, 104
- Rear lights 104
- Rear seat backs, folding 73
- Rear window, heated 69

- Refuelling 18
 - Telltale 13
 - Fuel gauge 13
 - Tank capacity 136
- Reminder function (MID) 44
- Remote control
 - for central locking 25
 - for on-board computer 52
- Reversing lights 56, 104
- Revolution counter 12
- R/FOG LIGHT FAILURE** 54
- Rims 121
- Roof load limit 134
- Roof rack 112
- Rubber parts 127
- Running in 16

- Seat belt catch tensioner 33
- Seat belts 33
 - Care 127
- Seat, mirror and steering wheel position memory 33
- Seats 28
 - Folding rear seat backs 73
 - Heating 29
 - Lumbar support 29
 - Seat back release 29
 - Position memory 33
- Selector lever, automatic transmission 60
- Service Interval indicator 43, 124
- Servotronic 90
- Ski bag 73
- SIDE LIGHT FAILURE** 54
- Side lights 36, 37
- Sliding roof 41, 101
- Snow chains 108, 121
- Spare wheel 97
- Spark plugs 137
- Specifications 132
- Speed, average 47

- Speed limit warning 48
- Speedometer 9
- Sports seats 28
- Spray jets, cleaning systems 89
- Starting aids 96
- Starting the engine 15
- Starting with a flat battery 96
- Steering column adjustment 30
- Steering wheel
 - Lock 14
 - Position adjustment, electric 30
 - Position memory 33
- Stopwatch 49
- Sun blind, electric 71
- Sun visors 32
- Sunroof 41, 101
- Swept volume, engine 132

- TAIL LIGHT FAILURE** 54
- Tail lights 56, 104
- Technical data 132
- Technical modifications 121
- Telephone 79
- Telltale lights 10
- Temperature display, see Coolant temperature display 13, 88
- Theftproofing 23
- Toolkit 93
- Tools, see Toolkit 86
- Top speed 135
- Torch, rechargeable, see Hand lamp 71
- Torque 132
- Towbar downthrust 134
- Towing a trailer 110
- Towing away 95

- Towing eyes 94
- Tow-starting 95
 - Eyes for tow-starting 94
- Track 133
- Trailer nose weight 134
- Trailer towing 110
- Trailer weight limits 134
- TRANS FAIL-SAFE PROG** 54
- Transmission
 - Automatic transmission 60
 - Transmission/gearbox oil, see Oils 136
- Triangle, warning 93
- Trip distance recorders 12
- Trunk 24, 101
- Turn indicators 37, 103
- Turning circle (overall) 133
- Turning circle (wheels) 133
- Type plate 81
- Tyre valve dust caps 120
- Tyres
 - Damage 119
 - Markings 119
 - New tyres 119
 - Pressures 19, 120
 - Punctures 97
 - Repairs 99
 - Sizes 121
 - Tread 118

- Underseal 125, 127

- Vanity mirrors 32
- V-belts 137
- Vehicle identification number 81
- Ventilation, see Automatic air conditioning 66

- Warning lights 10
- Warning triangle 93
- Washer fluid level 54
- Weight, gross 134
- Weights 126
- Wheel rims 121
- Wheel sizes 121
- Wheel stud wrench 97
- Wheel studs, anti-theft 100
- Wheelbase 133
- Wheel-changing 97
- Wheels, interchanging 119
- Width 133
- Window cleaning system, see Wipe wash system
- Window lifts 40
- Windscreen washer jets 89
- Winter operation
 - Driving hints 108
 - Measures on car 107
- Winter tyres 120, 121
- Wiper blades, changing 102
- Wipers 39
 - Care 127
 - Renewing blades 102
- Wipe/wash system 39
 - Reservoir 89
 - Jets 89

Note:
Index items in bold type are Check Control displays accompanied by the "SEE OWNER'S HANDBOOK" reminder.

Left side 125
Left side 126
Left side 127
Left side 128
Left side 129
Left side 130
Left side 131
Left side 132
Left side 133
Left side 134
Left side 135
Left side 136
Left side 137
Left side 138
Left side 139
Left side 140
Left side 141
Left side 142
Left side 143
Left side 144
Left side 145
Left side 146
Left side 147
Left side 148
Left side 149
Left side 150
Left side 151
Left side 152
Left side 153
Left side 154
Left side 155
Left side 156
Left side 157
Left side 158
Left side 159
Left side 160
Left side 161
Left side 162
Left side 163
Left side 164
Left side 165
Left side 166
Left side 167
Left side 168
Left side 169
Left side 170
Left side 171
Left side 172
Left side 173
Left side 174
Left side 175
Left side 176
Left side 177
Left side 178
Left side 179
Left side 180
Left side 181
Left side 182
Left side 183
Left side 184
Left side 185
Left side 186
Left side 187
Left side 188
Left side 189
Left side 190
Left side 191
Left side 192
Left side 193
Left side 194
Left side 195
Left side 196
Left side 197
Left side 198
Left side 199
Left side 200

Right side 125
Right side 126
Right side 127
Right side 128
Right side 129
Right side 130
Right side 131
Right side 132
Right side 133
Right side 134
Right side 135
Right side 136
Right side 137
Right side 138
Right side 139
Right side 140
Right side 141
Right side 142
Right side 143
Right side 144
Right side 145
Right side 146
Right side 147
Right side 148
Right side 149
Right side 150
Right side 151
Right side 152
Right side 153
Right side 154
Right side 155
Right side 156
Right side 157
Right side 158
Right side 159
Right side 160
Right side 161
Right side 162
Right side 163
Right side 164
Right side 165
Right side 166
Right side 167
Right side 168
Right side 169
Right side 170
Right side 171
Right side 172
Right side 173
Right side 174
Right side 175
Right side 176
Right side 177
Right side 178
Right side 179
Right side 180
Right side 181
Right side 182
Right side 183
Right side 184
Right side 185
Right side 186
Right side 187
Right side 188
Right side 189
Right side 190
Right side 191
Right side 192
Right side 193
Right side 194
Right side 195
Right side 196
Right side 197
Right side 198
Right side 199
Right side 200

Front 125
Front 126
Front 127
Front 128
Front 129
Front 130
Front 131
Front 132
Front 133
Front 134
Front 135
Front 136
Front 137
Front 138
Front 139
Front 140
Front 141
Front 142
Front 143
Front 144
Front 145
Front 146
Front 147
Front 148
Front 149
Front 150
Front 151
Front 152
Front 153
Front 154
Front 155
Front 156
Front 157
Front 158
Front 159
Front 160
Front 161
Front 162
Front 163
Front 164
Front 165
Front 166
Front 167
Front 168
Front 169
Front 170
Front 171
Front 172
Front 173
Front 174
Front 175
Front 176
Front 177
Front 178
Front 179
Front 180
Front 181
Front 182
Front 183
Front 184
Front 185
Front 186
Front 187
Front 188
Front 189
Front 190
Front 191
Front 192
Front 193
Front 194
Front 195
Front 196
Front 197
Front 198
Front 199
Front 200

Rear 125
Rear 126
Rear 127
Rear 128
Rear 129
Rear 130
Rear 131
Rear 132
Rear 133
Rear 134
Rear 135
Rear 136
Rear 137
Rear 138
Rear 139
Rear 140
Rear 141
Rear 142
Rear 143
Rear 144
Rear 145
Rear 146
Rear 147
Rear 148
Rear 149
Rear 150
Rear 151
Rear 152
Rear 153
Rear 154
Rear 155
Rear 156
Rear 157
Rear 158
Rear 159
Rear 160
Rear 161
Rear 162
Rear 163
Rear 164
Rear 165
Rear 166
Rear 167
Rear 168
Rear 169
Rear 170
Rear 171
Rear 172
Rear 173
Rear 174
Rear 175
Rear 176
Rear 177
Rear 178
Rear 179
Rear 180
Rear 181
Rear 182
Rear 183
Rear 184
Rear 185
Rear 186
Rear 187
Rear 188
Rear 189
Rear 190
Rear 191
Rear 192
Rear 193
Rear 194
Rear 195
Rear 196
Rear 197
Rear 198
Rear 199
Rear 200

Interior 125
Interior 126
Interior 127
Interior 128
Interior 129
Interior 130
Interior 131
Interior 132
Interior 133
Interior 134
Interior 135
Interior 136
Interior 137
Interior 138
Interior 139
Interior 140
Interior 141
Interior 142
Interior 143
Interior 144
Interior 145
Interior 146
Interior 147
Interior 148
Interior 149
Interior 150
Interior 151
Interior 152
Interior 153
Interior 154
Interior 155
Interior 156
Interior 157
Interior 158
Interior 159
Interior 160
Interior 161
Interior 162
Interior 163
Interior 164
Interior 165
Interior 166
Interior 167
Interior 168
Interior 169
Interior 170
Interior 171
Interior 172
Interior 173
Interior 174
Interior 175
Interior 176
Interior 177
Interior 178
Interior 179
Interior 180
Interior 181
Interior 182
Interior 183
Interior 184
Interior 185
Interior 186
Interior 187
Interior 188
Interior 189
Interior 190
Interior 191
Interior 192
Interior 193
Interior 194
Interior 195
Interior 196
Interior 197
Interior 198
Interior 199
Interior 200

Exterior 125
Exterior 126
Exterior 127
Exterior 128
Exterior 129
Exterior 130
Exterior 131
Exterior 132
Exterior 133
Exterior 134
Exterior 135
Exterior 136
Exterior 137
Exterior 138
Exterior 139
Exterior 140
Exterior 141
Exterior 142
Exterior 143
Exterior 144
Exterior 145
Exterior 146
Exterior 147
Exterior 148
Exterior 149
Exterior 150
Exterior 151
Exterior 152
Exterior 153
Exterior 154
Exterior 155
Exterior 156
Exterior 157
Exterior 158
Exterior 159
Exterior 160
Exterior 161
Exterior 162
Exterior 163
Exterior 164
Exterior 165
Exterior 166
Exterior 167
Exterior 168
Exterior 169
Exterior 170
Exterior 171
Exterior 172
Exterior 173
Exterior 174
Exterior 175
Exterior 176
Exterior 177
Exterior 178
Exterior 179
Exterior 180
Exterior 181
Exterior 182
Exterior 183
Exterior 184
Exterior 185
Exterior 186
Exterior 187
Exterior 188
Exterior 189
Exterior 190
Exterior 191
Exterior 192
Exterior 193
Exterior 194
Exterior 195
Exterior 196
Exterior 197
Exterior 198
Exterior 199
Exterior 200



**The ultimate
driving
machine**

Best. Nr. 01 41 9 787 721 englisch